



Scan QR Code
with your smart phone



TALC INDUSTRIES
ONE STOP FOR MEDICAL EQUIPMENT

www.talcindustries.com



TALC INDUSTRIES
ONE STOP FOR MEDICAL EQUIPMENT

www.talcindustries.com



TALC INDUSTRIES is one of the most famous Manufacturing companies in the field of Surgical Instruments such as...

General Surgery Instruments, Anaesthesia & Diagnostics, Gynecology & Obstetric Instruments, Cardiovascular Instruments, Ear Nose Throat (E.N.T) Instruments, Orthopedic Instruments, Eye Surgery Instruments and Hollowwares in the world.

Founded in 2004, it has strong dedication to provide excellent services to its customers around the globe.

Talc Industries is equipped with latest technical tools and highly skilled labor to maintain the quality of instruments by following international quality standard (ISO 9001, 13485, CE, FDA/CGMP).

TALC INDUSTRIES keenly focuses on the development of new products by applying innovative skills of its staff and meets the upcoming requirements of healthcare sectors.

Best Regards.

TALC INDUSTRIES

www.talcindustries.com

BEST PRESTIGIOUS QUALITY



CERTIFICATIONS

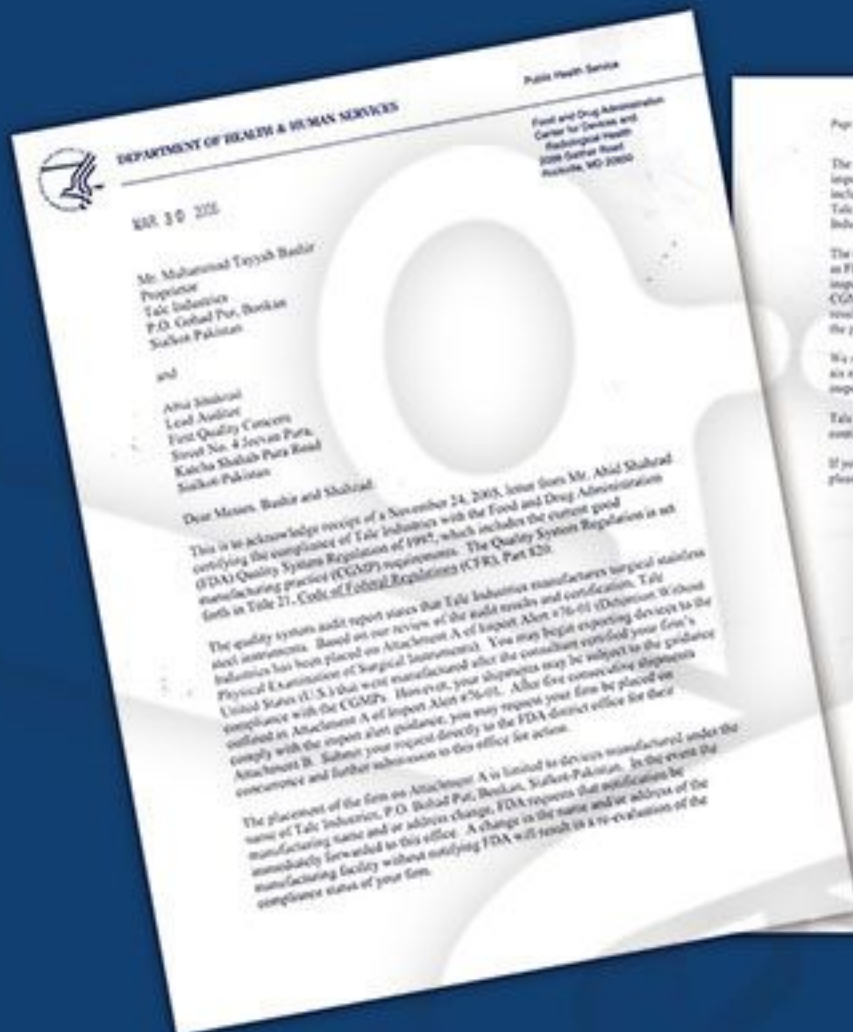

01

GENERAL INSTRUMENTS

Scalpel Handles
Operating Scissors
Dissecting Scissors
Dressing Forceps
Tissue Forceps
Artery Forceps

kidney Pedicle Clamp
Clamps, Hysterectomy
Towel Forceps
Supercut Scissors
Retractors
Abdominal Retractors

**01 to
151**

**152 to
154**

Percussion Hammers
Sensibility Instruments, Stethoscopes

DIAGNOSTICS INSTRUMENTS

02

03

VACCINATION & PUNCTURE INSTRUMENTS

Trocars
Suction Tubes

**155 to
162**

**163 to
184**

Micro-Needle Holders
Needle Holders
Reverdin Needles
Needle Holders Tungsten Carbide Inserts

SUTURE INSTRUMENTS

04

05

DRESSING INSTRUMENTS

Bandage Scissors
Clothing Scissors
Plaster Scissors
Plaster-of-Paris Knives, Saws
Plaster Cast Instruments

**185 to
189**

**190 to
193**

Pin Cutter & wire Cutters
Pliers
Pliers & Calipers

ORTHOPEDIC INSTRUMENTS

06

07

BONE SURGERY INSTRUMENTS

Bone Chisels & Gouges
Hemostats
Mallets
Bone Curettes
Periosteal Raspatories
Elevators
Bone Levers
Meniscotomy Knives

Bone Holding Forceps
Bone Rongeur Forceps
Bone Cutting Forceps
Flat Nose Pliers
Wire Cutting Pliers
Extension Bows
Basic Orthopedic Sets

**194 to
268**

**269 to
271**

Nail Nippers
Cuticle Nippers
Cuticle Scissors
Loading & Sterilizing Forceps

ASEPSIS INSTRUMENTS

08

09

RHINOLOGY INSTRUMENTS

Nasal Specula
Dressing Tampon
Nasal Cutting Forceps
Septum Scissors
Sphenoid Punches,
Antrum Punch Forceps

Septum & Periosteal
Elevators
Rhinoplastic
Instruments etc
Sharp Curettes
Adenoid Curettes

**272 to
302**

**303 to
337**

Bone & Rib Shears
Rib Spreaders
Tissue & Organ Holding Forceps
Atrauma Tissue Forceps
Atrauma Bulldog Forceps
Atrauma Cardiovascular Forceps
Instruments for Cranial Opening

CARDIOVASCULAR INSTRUMENTS

10

11

INTESTINES STOMACH RECTUM INSTRUMENTS

Tissue & Organ Holding Forceps
Intestinal Clamp Forceps
Stomach Clamp Forceps
Rectal Specula
Retractors
Hemorrhoidal (Pile) Forceps

**338 to
350**

**351 to
358**

Kidney Stone Forceps
Gall Stone Scoops
Prostatic Retractors

Bladder Retractors
Dilating Bougies
Metal Catheters

LIVER, GALL BLADDER KIDNEY INSTRUMENTS

12

13

RECTAL &
GENTO-URINARY
INSTRUMENTS

Specula
Retractors

**359 to
361**

**362 to
000**

Trachea Dilators
Trachea Tubes

TRACHEOTOMY
INSTRUMENTS

14

15

GYNECOLOGY
INSTRUMENTS

Vaginal Specula
Retractors, Endospecula
Uterine Dilators
Tenaculum Forceps
Myoma Instruments

Uterine Elevating
Forceps
Suction Biopsy Curettes
Cervical Biopsy &
Specimen Forceps
Uterine Scoops & Curette
Obstetrical Forceps

**363 to
393**

**394 to
418**

Gales Hooks
Dura Dissectors
Brain Spatulas
Nerve Root Retractors
Elevator, Knives, Dura Hooks

Lamina Spreaders
Intervertebral Disc
Laminectomy Rongeurs
Brain Leyla Retractors

NEURO-SURGERY
INSTRUMENTS

16

17

OTOLOGY
INSTRUMENTS

Micro Ear Forceps
Wire Closure Forceps
Knives, Tuning Forks
Foreign Body Forceps
Curettes & Spoons
Hooklets

**419 to
437**

**438 to
449**

Mouth Gags
Tongue Depressors
Soft Tissue Retractors
Periosteal Elevators
Awls
Disimpaction Forceps

ORAL &
FACIAL SURGERY
INSTRUMENTS

18

19

TONSILS & **LARYNGO** INSTRUMENTS

Tonsils Knives
Tonsils Seizing Forceps
Universal Handles & Interchangeable Tubes
Cutting & Grasping Forceps Tips

**450 to
456**

**457 to
464**

Catheter Forceps
Laryngoscopes
Otoscope & ENT Diagnostic Set

ANESTHESIA INSTRUMENTS

20

21

ENDOSCOPIC INSTRUMENTS

Grasping Forceps
Dissecting Forceps & Hooks
Scissors
Detach Scissors System
Biopsy Instruments
Specialization

**465 to
481**

**482 to
487**

Forceps, Scissors
Needle Holders
Scissors & Needle Holders

MICRO SURGERY INSTRUMENTS

22

23

OPHTHALMIC INSTRUMENTS

Eye Forceps
Fixation forceps
Utility, Suture Forceps
Jewelers Forceps
Needle Holders
Eye Scissors

**488 to
514**

**515 to
563**

Retractors
Breast Dissector
Markers & Calipers
Speculas & Septum
Endo Dissectors
Fiber Optic Light Guide Cable

Cannulas for infiltration
Lipo-Suction Cannulas
Set Suggestion
Handle For Cannulas

PLASTIC SURGERY & LIPO-SUCTION INSTRUMENTS

24-25



CONTACT DETAILS



Factory Address:

Pacca Garha, Kashmir Road, Sialkot 51310, Punjab, Pakistan

Tel: +92 52 429 5908

Fax: +92 52 435 2475

Cell: +92 334 111 2411, 315 111 2411

What'sapp: +92 321 613 8119 

Skype/Wechat/Line: talcinds

Email: inquiry@talcindustries.com
talcinds@gmail.com

Web: www.talcindustries.com



WWW.TALCINDUSTRIES.COM



+92 334 111 2411



TALCINDS

01

GENERAL INSTRUMENTS



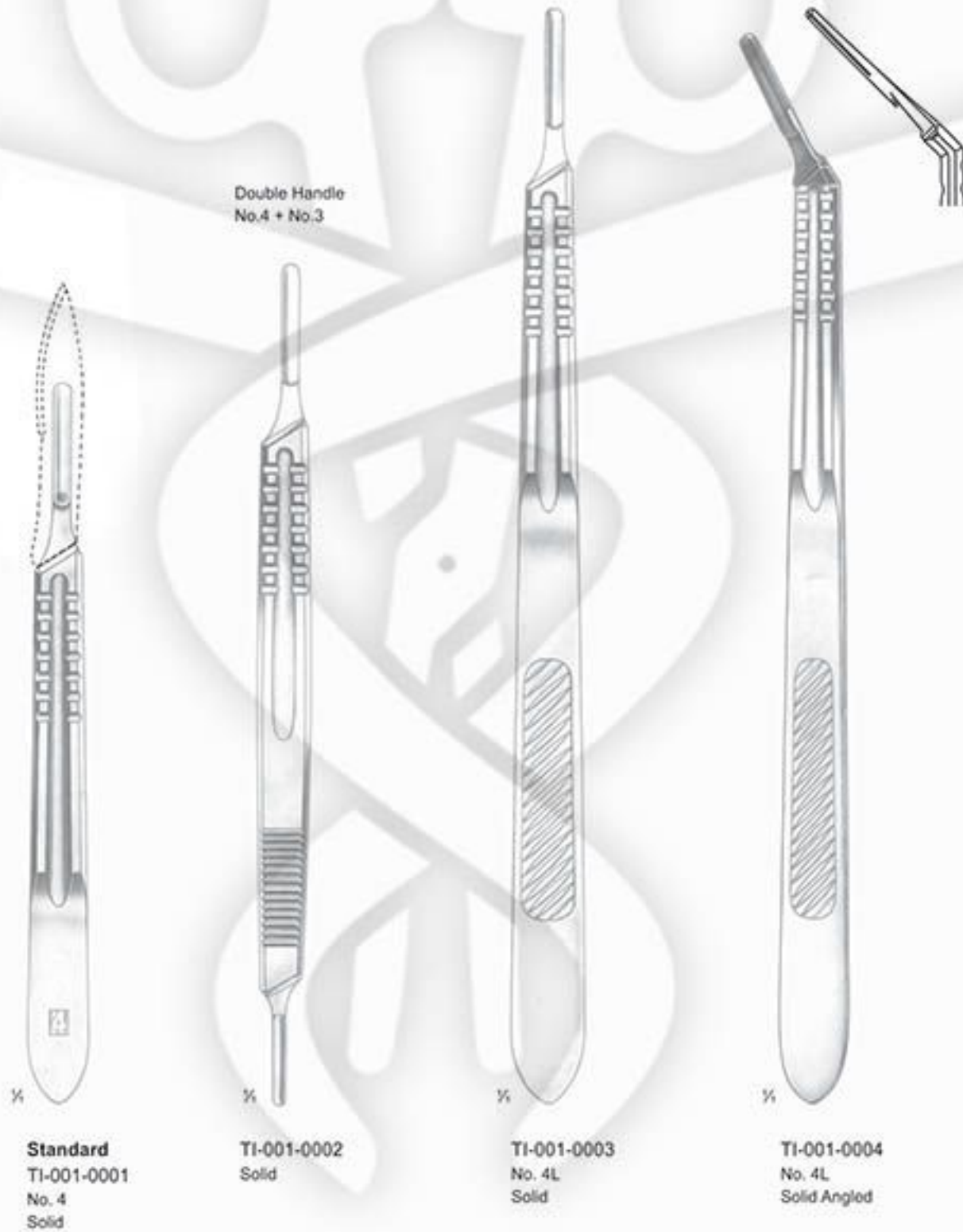



Standard
TI- 002-0005
No. 3
Solid

TI- 002-0006
No. 3
Solid

TI- 002-0007
No. 3
Solid

TI- 002-0008
No. 3L
Solid Straight

TI- 002-0009
No. 3L
Solid Angled



Stacke
TI-004-0035
10.0 cm / 4 $\frac{1}{4}$ "
1 mm ϕ



TI-004-0036 14.0 cm / 5 $\frac{1}{2}$ "
TI-004-0037 16.0 cm / 6 $\frac{1}{4}$ "
TI-004-0038 20.0 cm / 8"



TI-004-0039 11.5 cm / 4 $\frac{1}{2}$ "
TI-004-0040 13.0 cm / 5"
TI-004-0041 14.0 cm / 5 $\frac{1}{2}$ "
TI-004-0042 16.0 cm / 6 $\frac{1}{4}$ "
TI-004-0043 18.0 cm / 7"
TI-004-0044 20.0 cm / 8"



TI-004-0045 13.0 cm / 5"
TI-004-0046 14.0 cm / 5 $\frac{1}{2}$ "
TI-004-0047 16.0 cm / 6 $\frac{1}{4}$ "
TI-004-0048 18.0 cm / 7"



$\frac{1}{2}$
Doyen
TI-004-0049
14.0 cm / 5 $\frac{1}{2}$ "



$\frac{1}{2}$
Nelaton
TI-004-0050
16.0 cm / 6 $\frac{1}{4}$ "



Fluhrer
TI-005-0051
40.0 cm / 16"
of tin



Babcock
BI-005-0052
40.0 cm / 16"



TI-005-0053
complete with 3 cones



TI-005-0054
Probe, malleable, only



TI-005-0055
Set of cones



Nabatoff
TI-006-0056
138x100x25 mm



Olive, Ø 3 mm
Olive, Ø 6 mm
Olive, Ø 9 mm
Olive, Ø 12 mm
Olive, Ø 15 mm
flexibles

Spare Parts



TI-006-0057
Ø 3 mm



TI-006-0058
Ø 6 mm



TI-006-0059
Ø 9 mm



TI-006-0060
Ø 12 mm



TI-006-0061
Ø 15 mm

Olive, Ø 3 mm
Olive, Ø 6 mm
Olive, Ø 9 mm
Olive, Ø 12 mm
Olive, Ø 15 mm
Handle only
Cable, flexible, stainless
Metal case

Olive, Ø 3 mm
Olive, Ø 6 mm
Olive, Ø 9 mm
Olive, Ø 12 mm
Olive, Ø 15 mm
for traction flexibles inoxidable

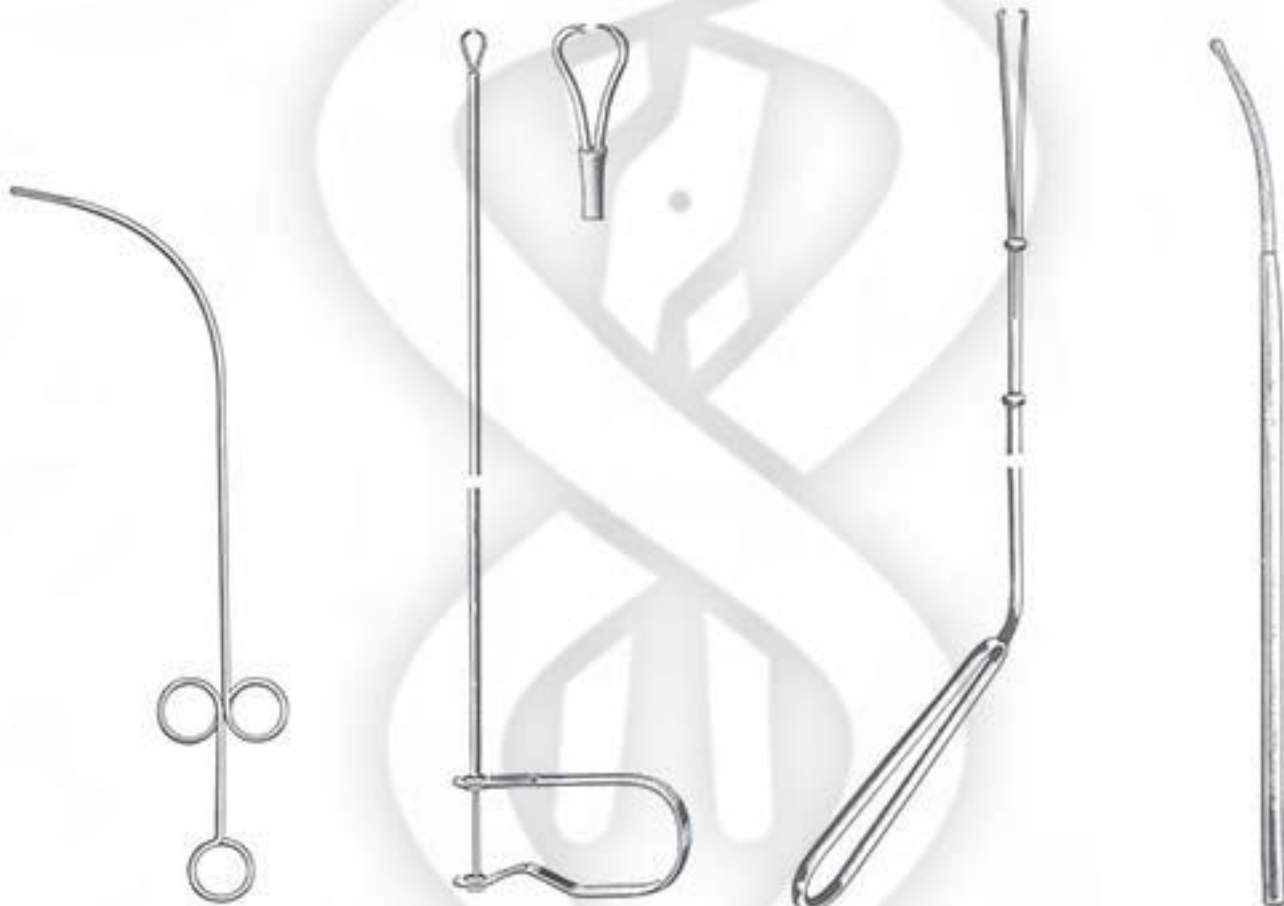

Fein
TI-007-0062
28.0 cm / 11"

TI-007-0063
45.0 cm / 17 1/2"

TI-007-0064
40.0 cm / 15 1/2"

Playfair
TI-007-0065
31.0 cm / 12 1/4"

Blunt / Blunt

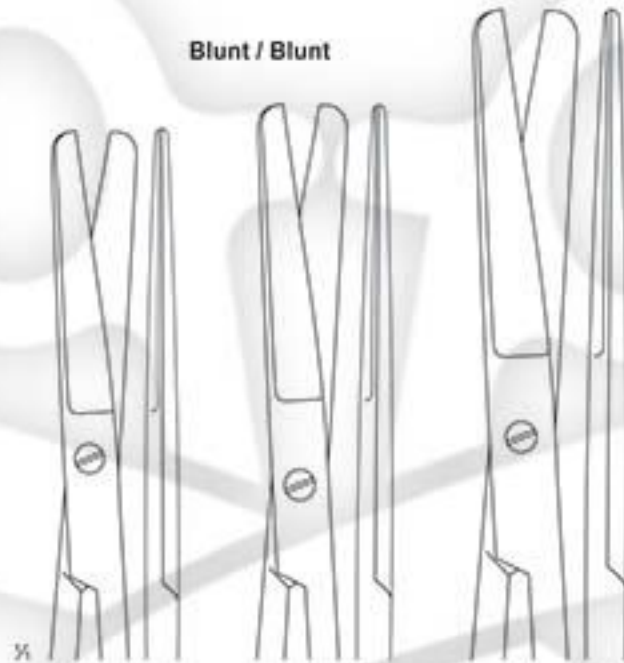

TI-008-0066
10.5 cm / 4 1/8"

TI-008-0067
11.5 cm / 4 1/2"

TI-008-0068
13.0 cm / 5"

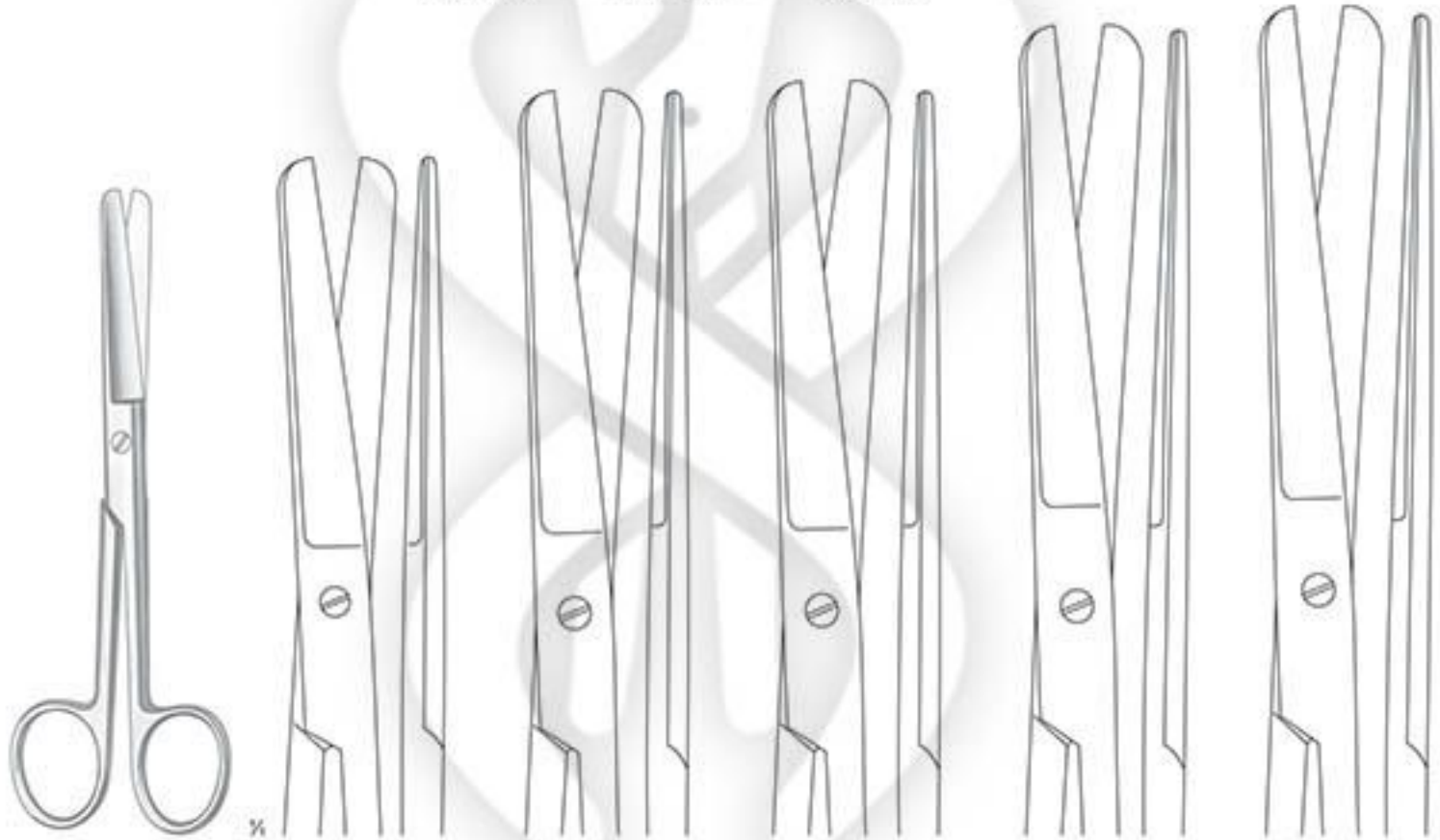

Standard

TI-008-0069
14.0 cm / 5 1/2"

TI-008-0070
15.5 cm / 6"

TI-008-0071
16.5 cm / 6 1/2"

TI-008-0072
18.5 cm / 7 1/4"

TI-008-0073
20.0 cm / 8"

Sharp / Blunt

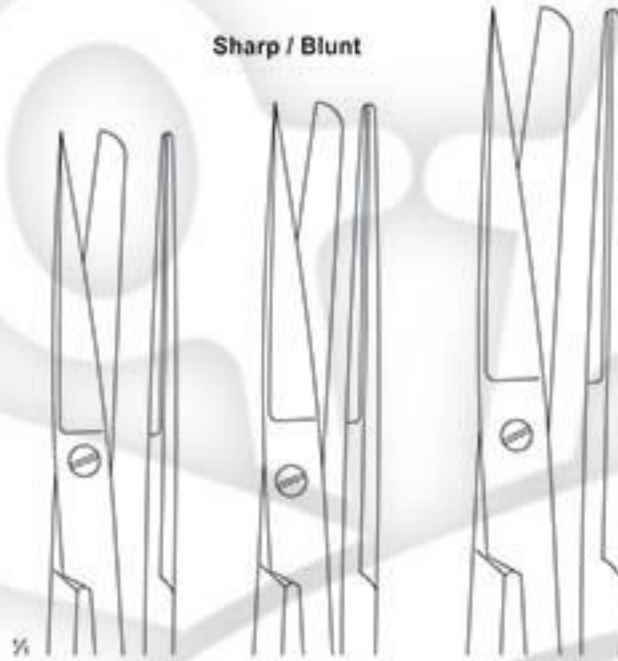

TI-009-0074
10.5 cm / 4 1/8"

TI-009-0075
11.5 cm / 4 1/2"

TI-009-0076
13.0 cm / 5"



Standard

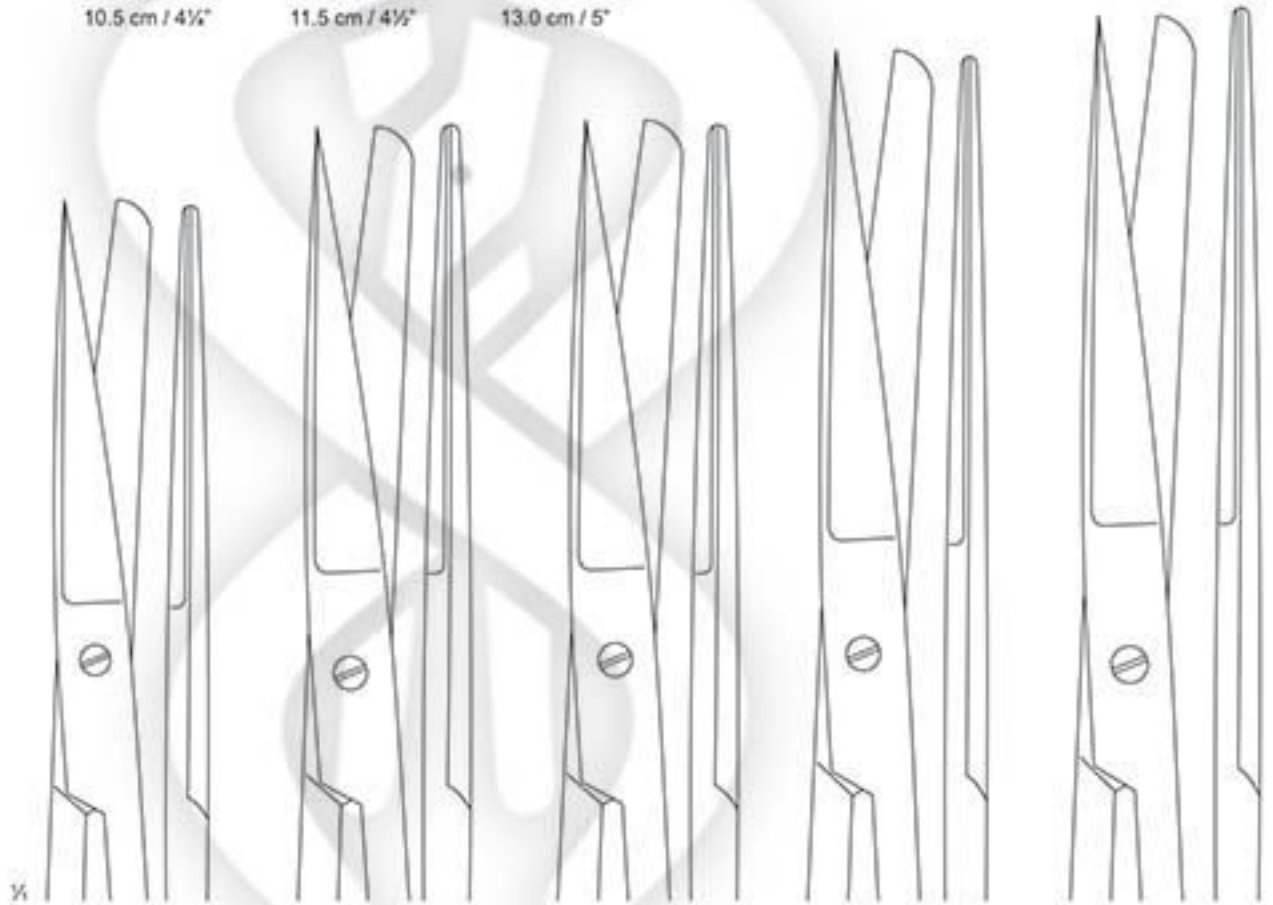

TI-009-0077
14.0 cm / 5 1/2"

TI-009-0078
15.5 cm / 6"

TI-009-0079
16.5 cm / 6 1/2"

TI-009-0080
18.5 cm / 7 1/4"

TI-009-0081
20.0 cm / 8"

Sharp / Sharp



Standard

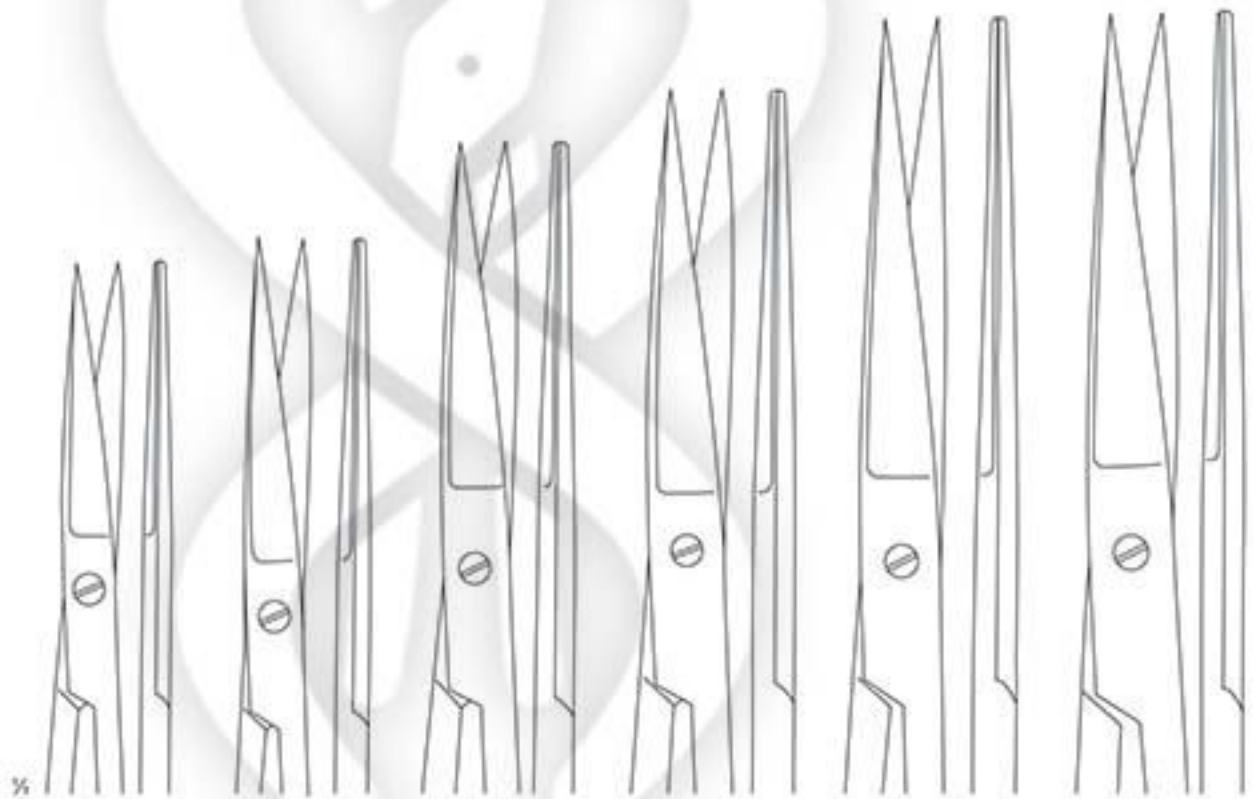

TI-010-0082
10.5 cm / 4 $\frac{1}{4}$ "

TI-010-0083
11.5 cm / 4 $\frac{1}{2}$ "

TI-010-0084
13.0 cm / 5"

TI-010-0085
14.0 cm / 5 $\frac{1}{2}$ "

TI-010-0086
15.5 cm / 6"

TI-010-0087
16.5 cm / 6 $\frac{1}{2}$ "

Blunt / Blunt

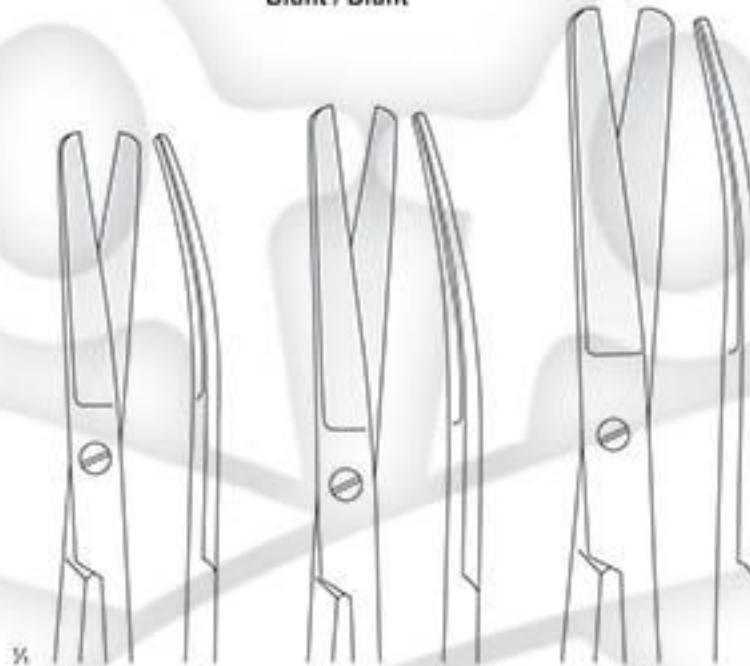

TI-011-0088
11.5 cm / 4½"

TI-011-0089
13.0 cm / 5"

TI-011-0090
14.0 cm / 5½"



Standard

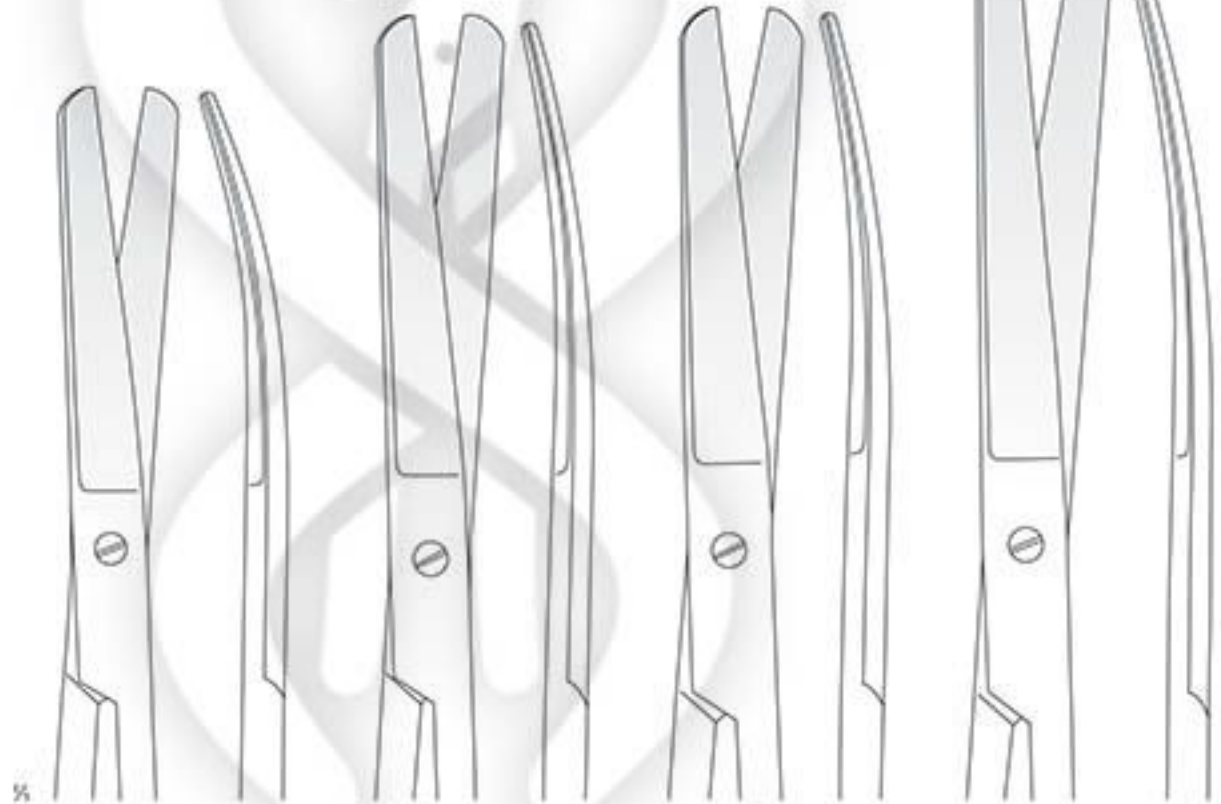

TI-011-0091
15.5 cm / 6"

TI-011-0092
16.5 cm / 6½"

TI-011-0093
18.5 cm / 6¾"

TI-011-0094
20.0 cm / 8"

Sharp / Blunt

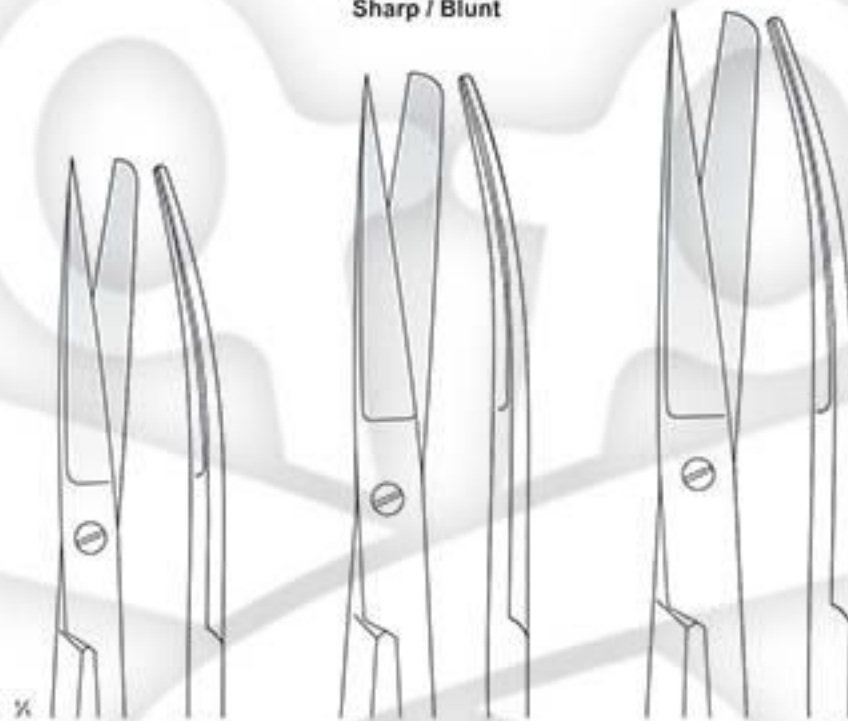

TI-012-0095
11.5 cm / 4 1/4"

TI-012-0096
13.0 cm / 5"

TI-012-0097
14.0 cm / 5 1/2"



Standard

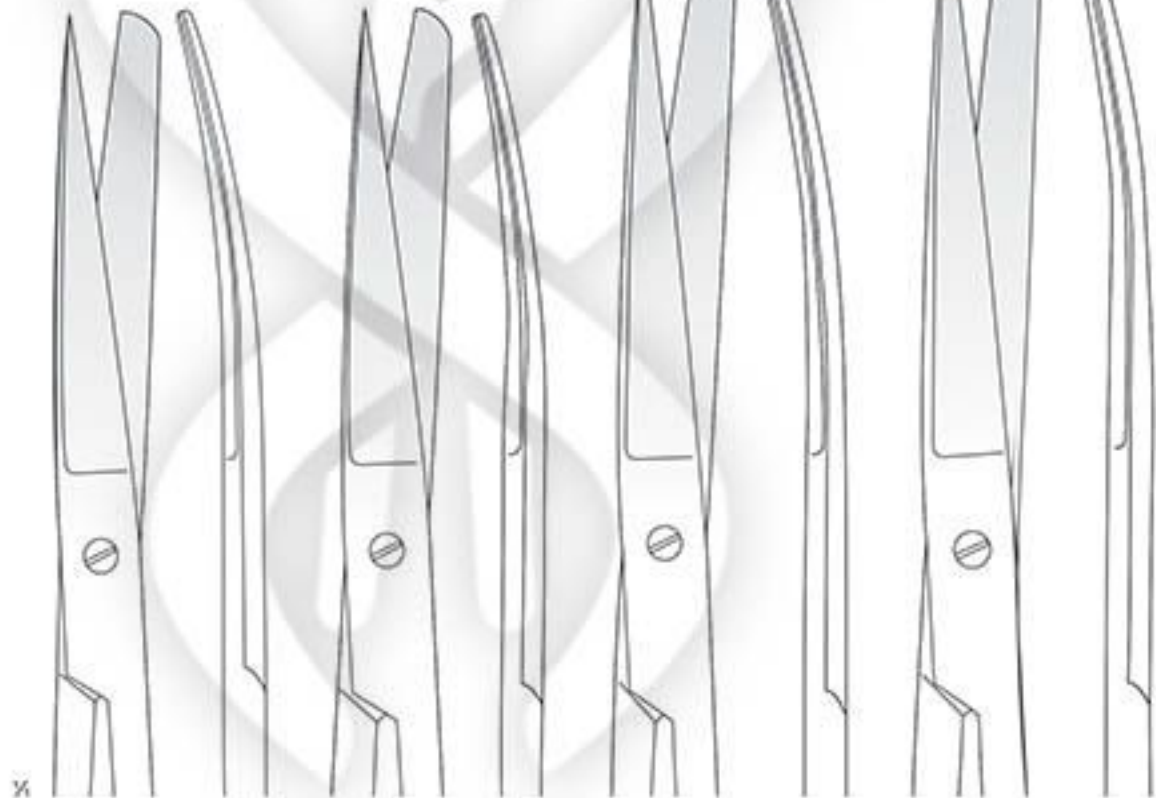

TI-012-0098
15.5 cm / 6"

TI-012-0099
16.5 cm / 6 1/2"

TI-012-0100
18.5 cm / 7 1/4"

TI-012-0101
20.0 cm / 8"

Sharp / Sharp



Standard

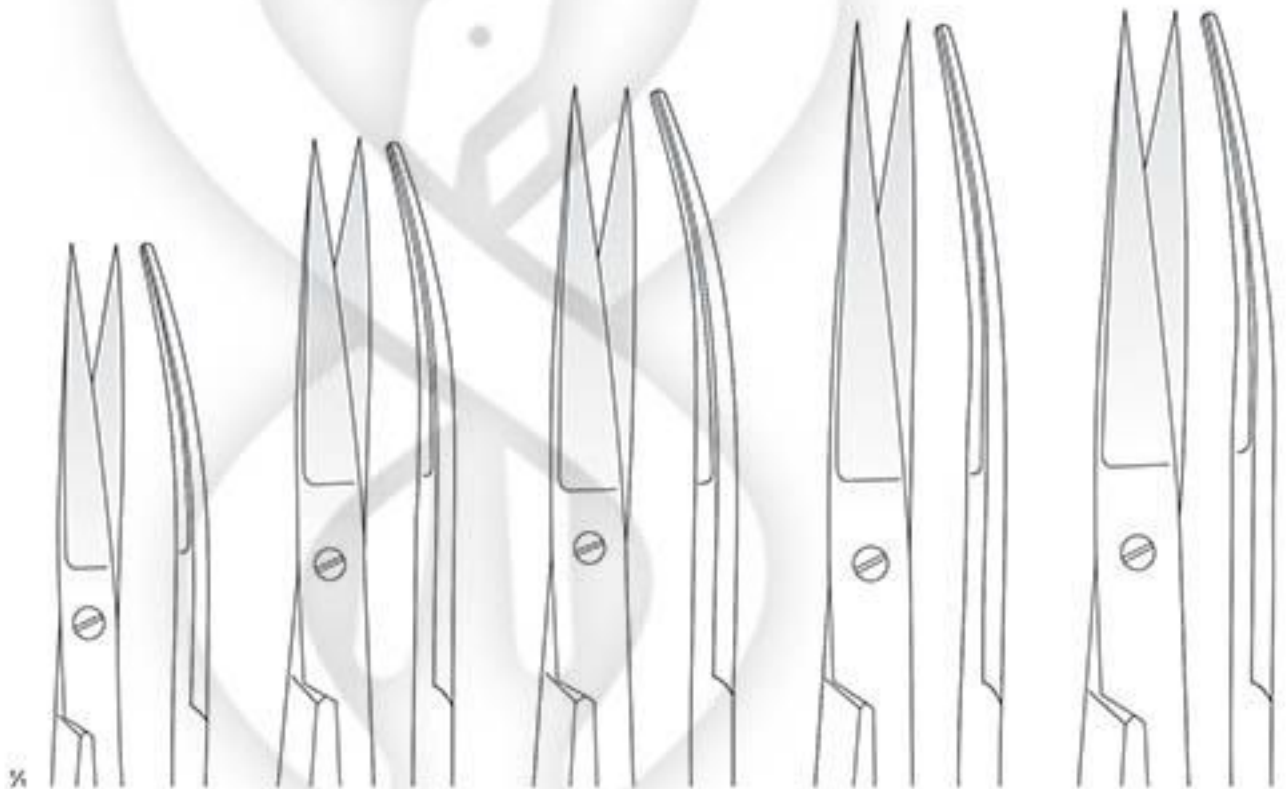

✕

TI-013-0102
11.5 cm / 4½"

TI-013-0103
13.0 cm / 5"

TI-013-0104
14.0 cm / 5½"

TI-013-0105
15.5 cm / 6"

TI-013-0106
16.5 cm / 6½"



Incision Scissors



TI-014-0107
13.0 cm / 5"



TI-014-0108
14.0 cm / 5 1/2"



Deaver



TI-014-0109
14.0 cm / 5 1/2"

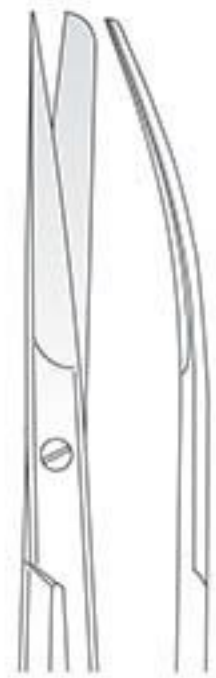

TI-014-0110
14.0 cm / 5 1/2"

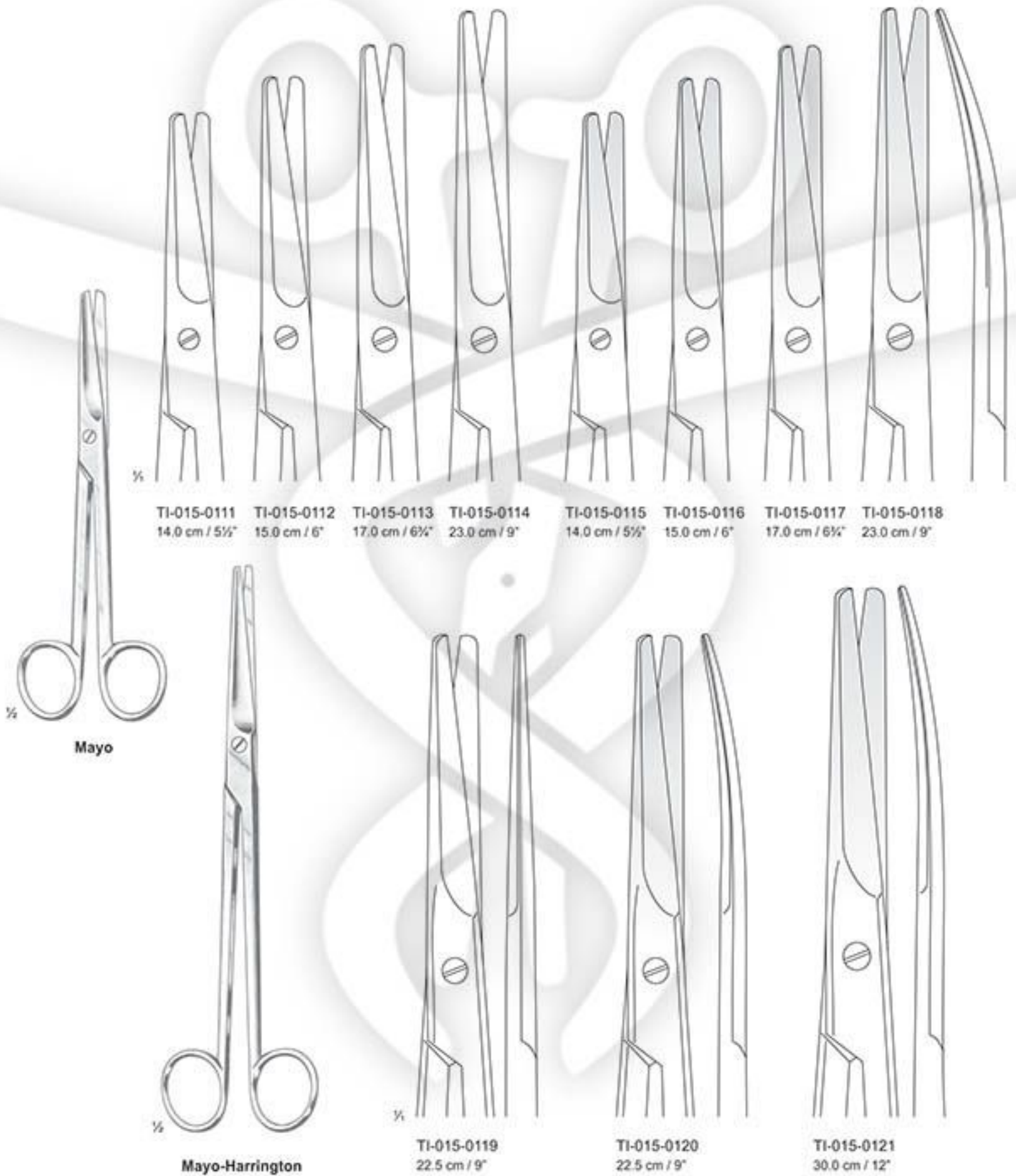

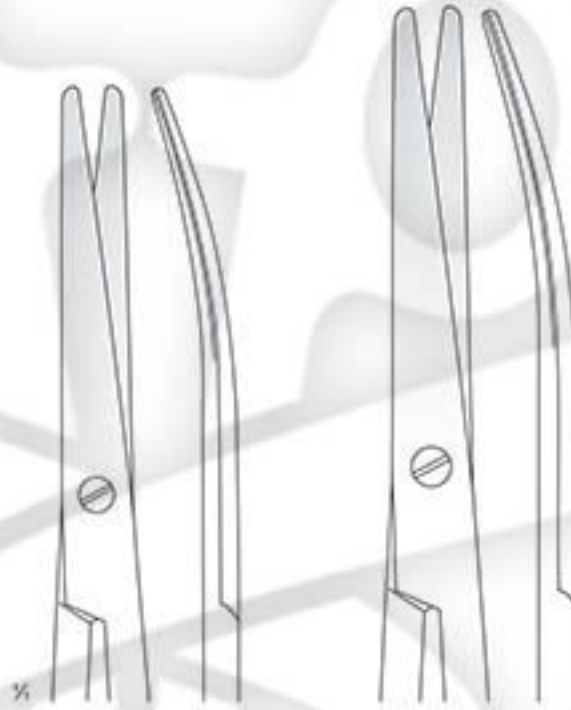

TI-016-0122
15.0 cm / 6"

TI-016-0123
17.0 cm / 6 1/4"



Mayo-Stille

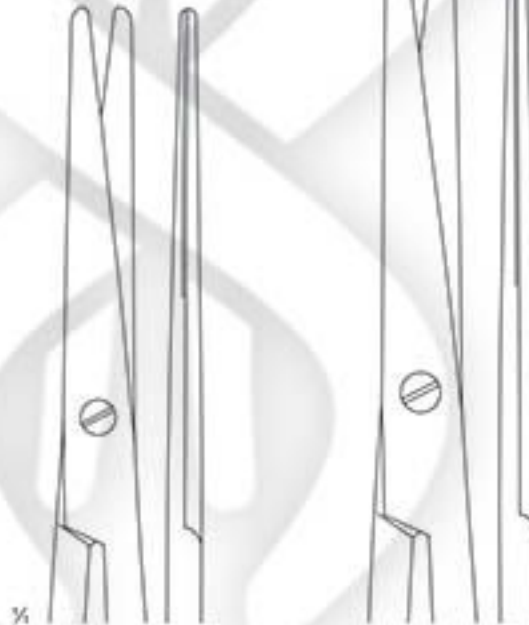

TI-016-0124
15.0 cm / 6"

TI-016-0125
17.0 cm / 6 1/4"



TI-017-0126
16.0 cm / 6 $\frac{1}{4}$ "

TI-017-0127
19.0 cm / 7 $\frac{1}{2}$ "

TI-017-0128
21.0 cm / 8 $\frac{1}{4}$ "



Mayo-Stille

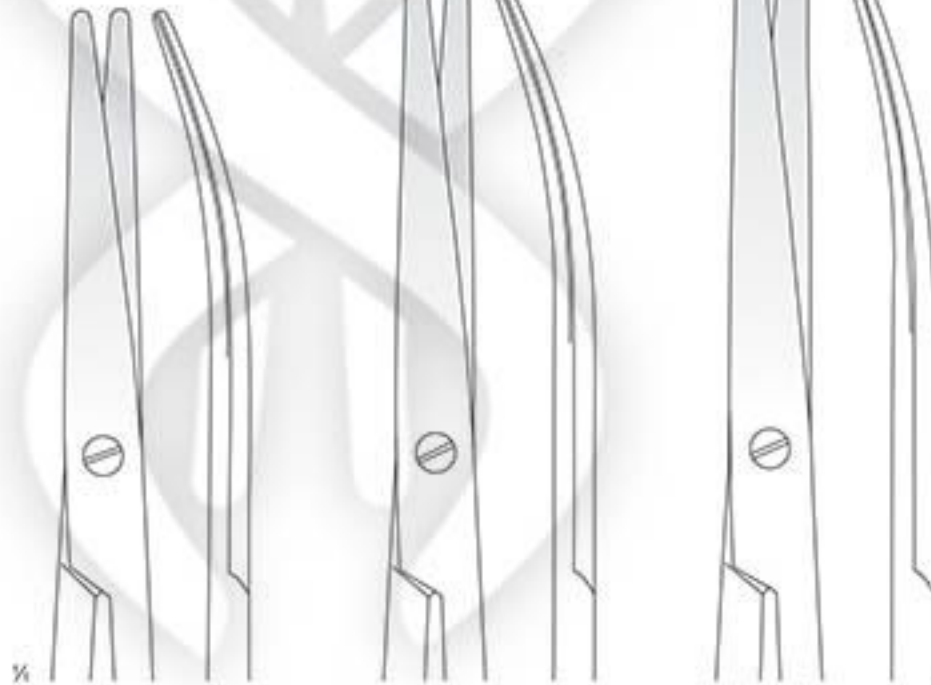

TI-017-0129
16.0 cm / 6 $\frac{1}{4}$ "

TI-017-0130
19.0 cm / 7 $\frac{1}{2}$ "

TI-017-0131
21.0 cm / 8 $\frac{1}{4}$ "



Mayo-Noble



TI-018-0132
17.0 cm / 6 3/4"



TI-018-0133
17.0 cm / 6 3/4"



Wertheim



TI-018-0134
14.0 cm / 5 1/2"



TI-018-0135
19.5 cm / 7 3/4"



TI-018-0136
22.5 cm / 9"



Kelly



TI-019-0137
16.0 cm / 6 1/4"

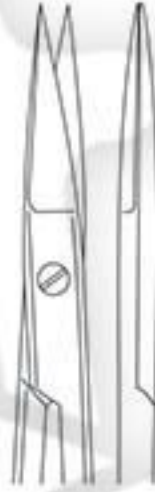

TI-019-0138
18.0 cm / 7"



TI-019-0139
16.0 cm / 6 1/4"



TI-019-0140
18.0 cm / 7"



Doyen



TI-019-0141
17.5 cm / 7"



TI-019-0142
17.0 cm / 6 3/4"



Metzenbaum

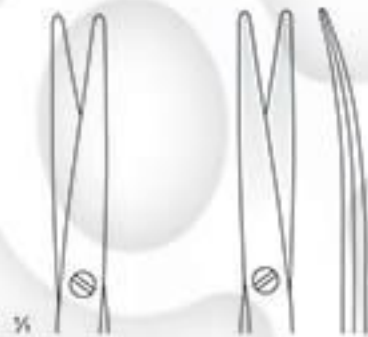

TI-020-0143
11.5 cm / 4 1/2"

TI-020-0144
11.5 cm / 4 1/2"

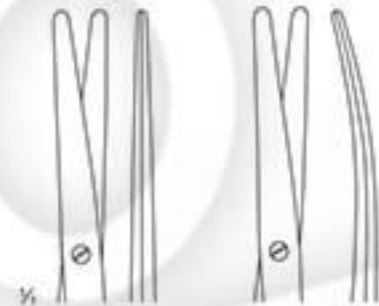

TI-020-0145
15.0 cm / 6"

TI-020-0146
15.0 cm / 6"



Metzenbaum



Metzenbaum



TI-020-0147
14.0 cm / 5 1/2"

TI-020-0148
14.0 cm / 5 1/2"

TI-020-0149
14.0 cm / 5 1/2"

TI-020-0150
14.0 cm / 5 1/2"

TI-020-0151
14.0 cm / 5 1/2"

TI-020-0152
14.0 cm / 5 1/2"

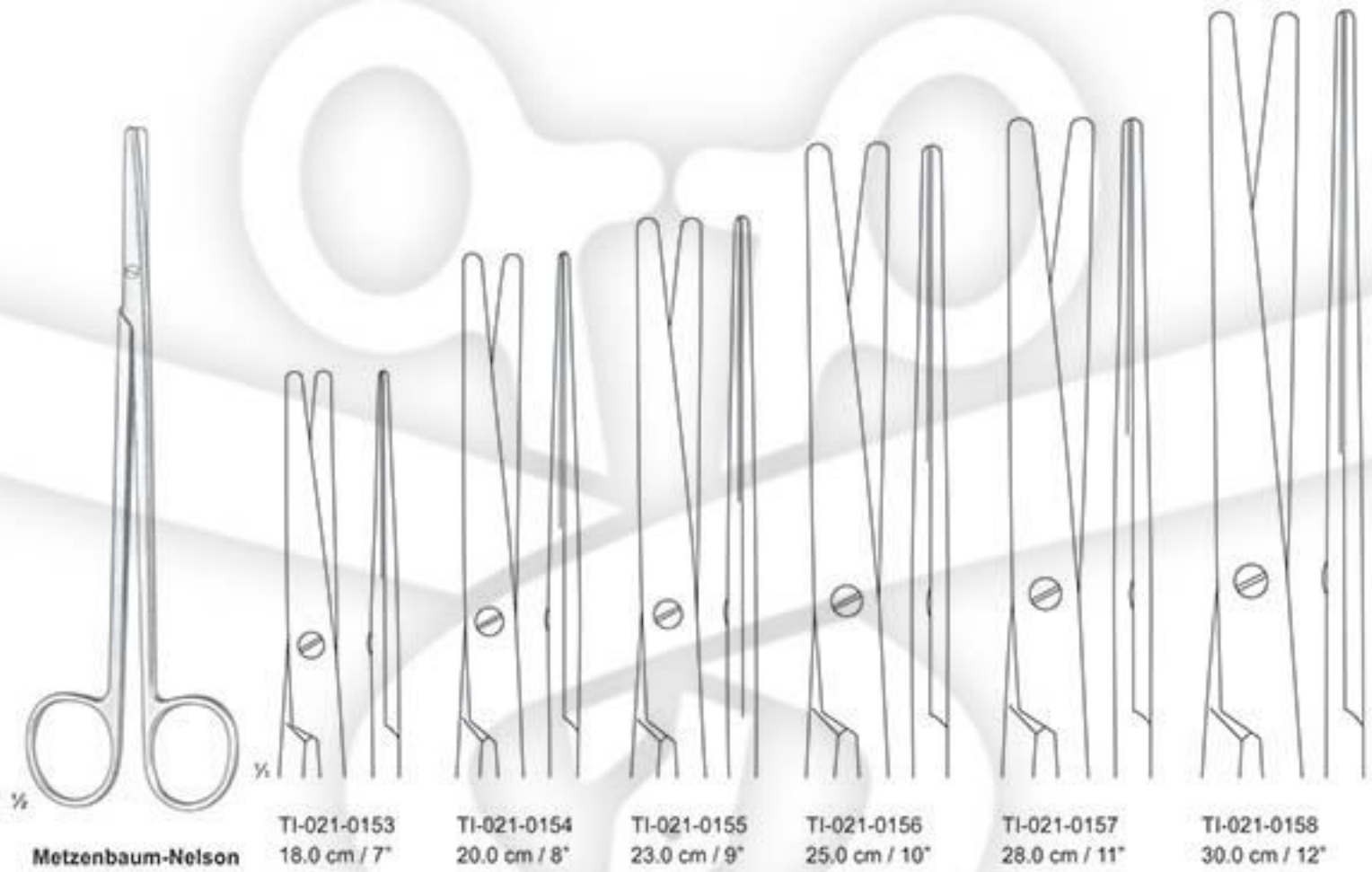

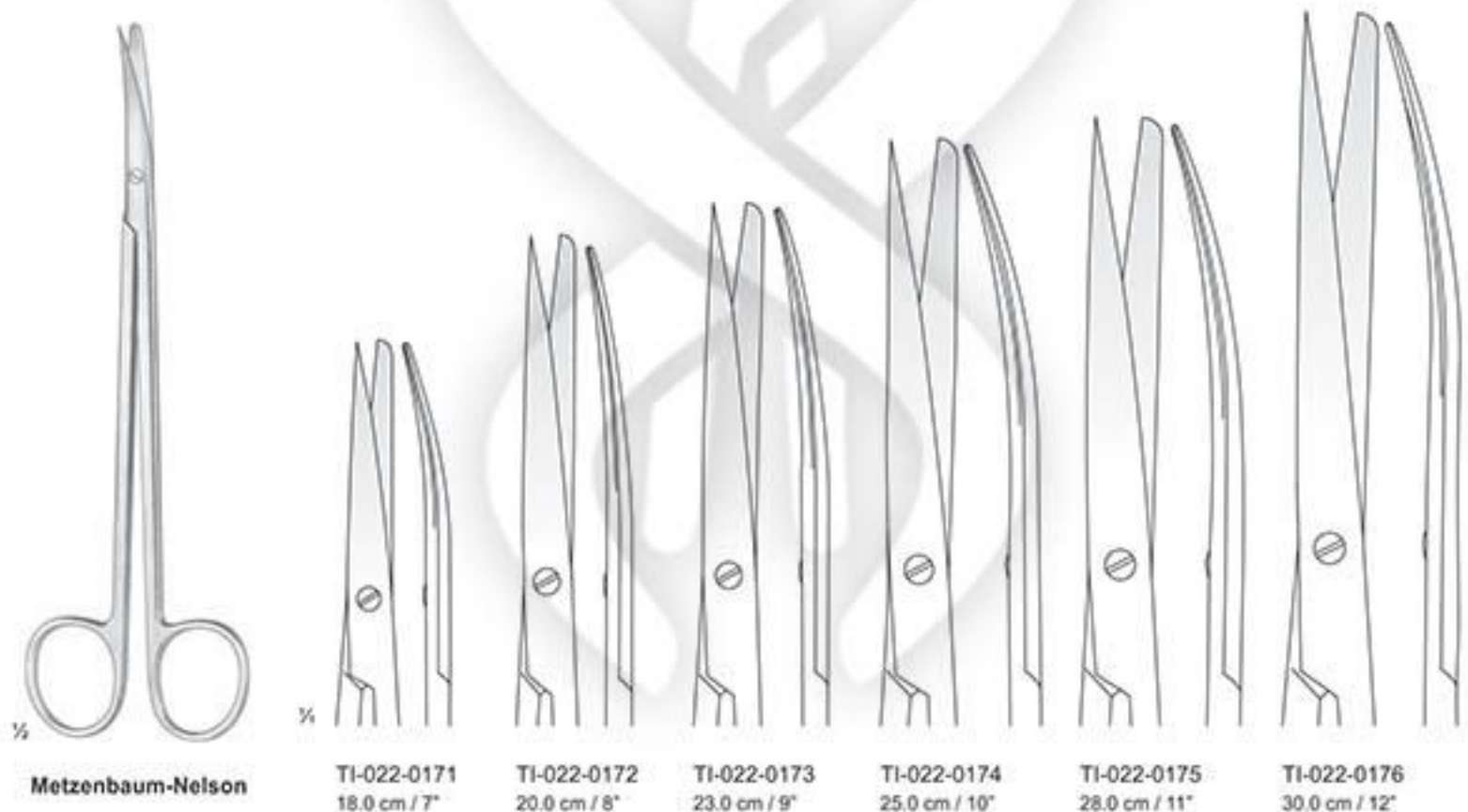
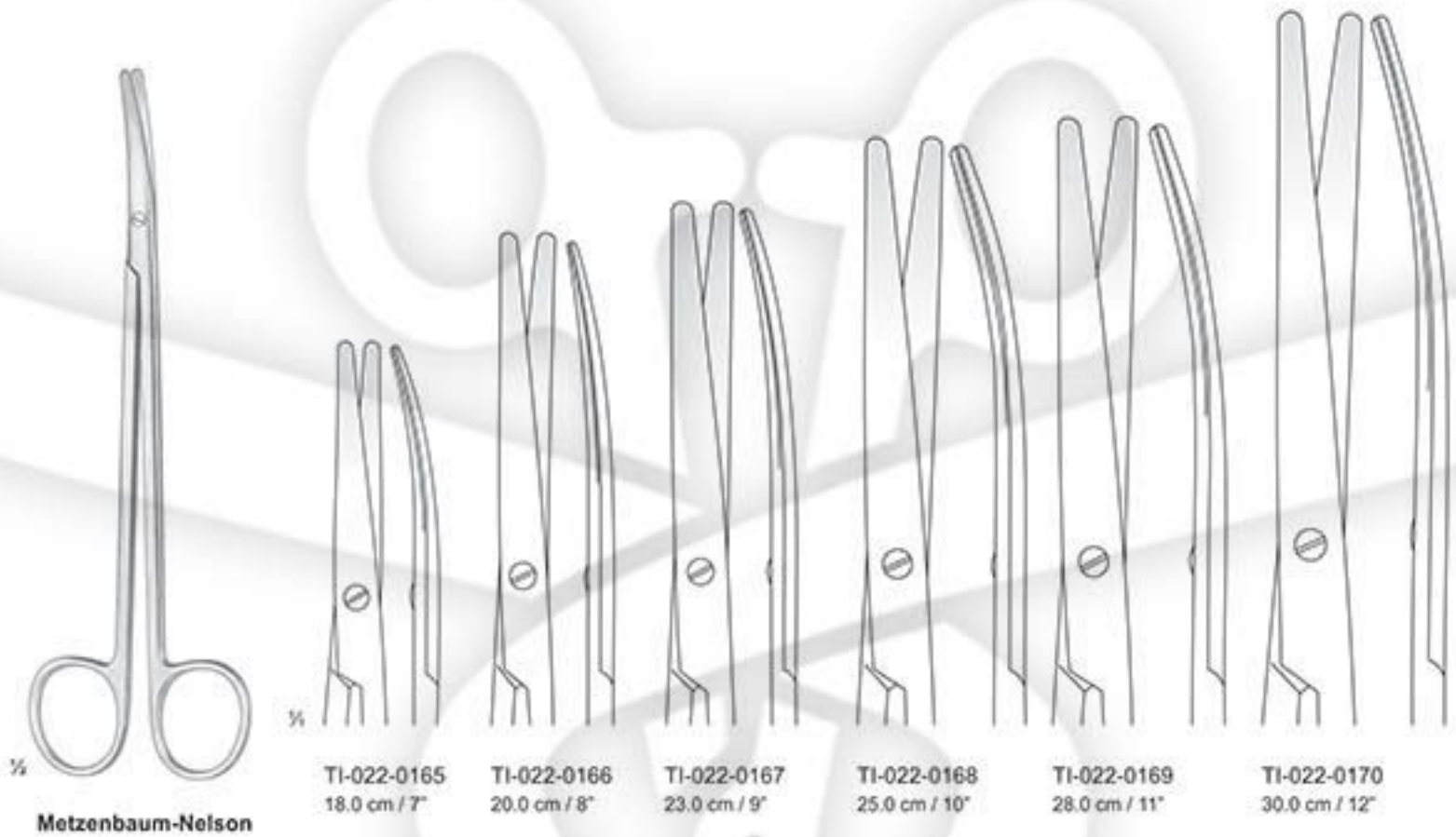



Fine Operating Scissors



blades, also for undermining

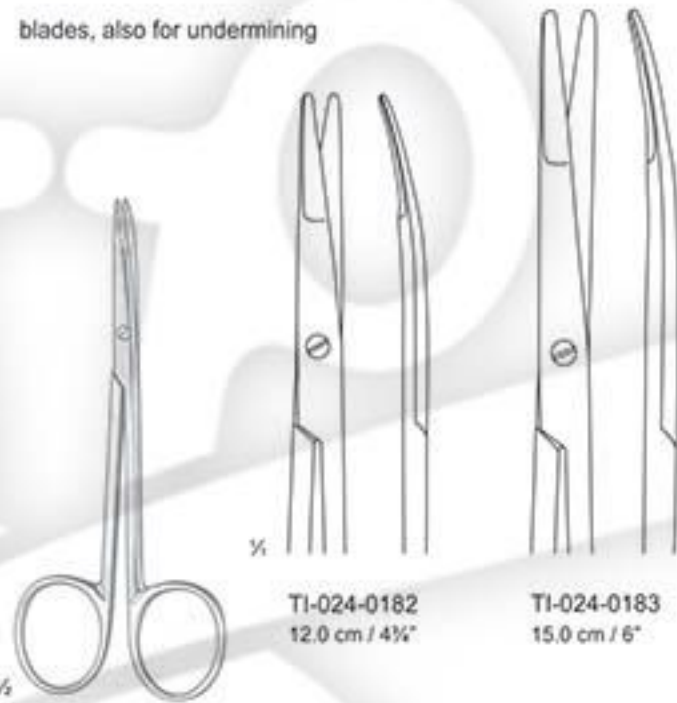

TI-024-0182
12.0 cm / 4 3/4"

TI-024-0183
15.0 cm / 6"

Outside cutting edge

Kilner

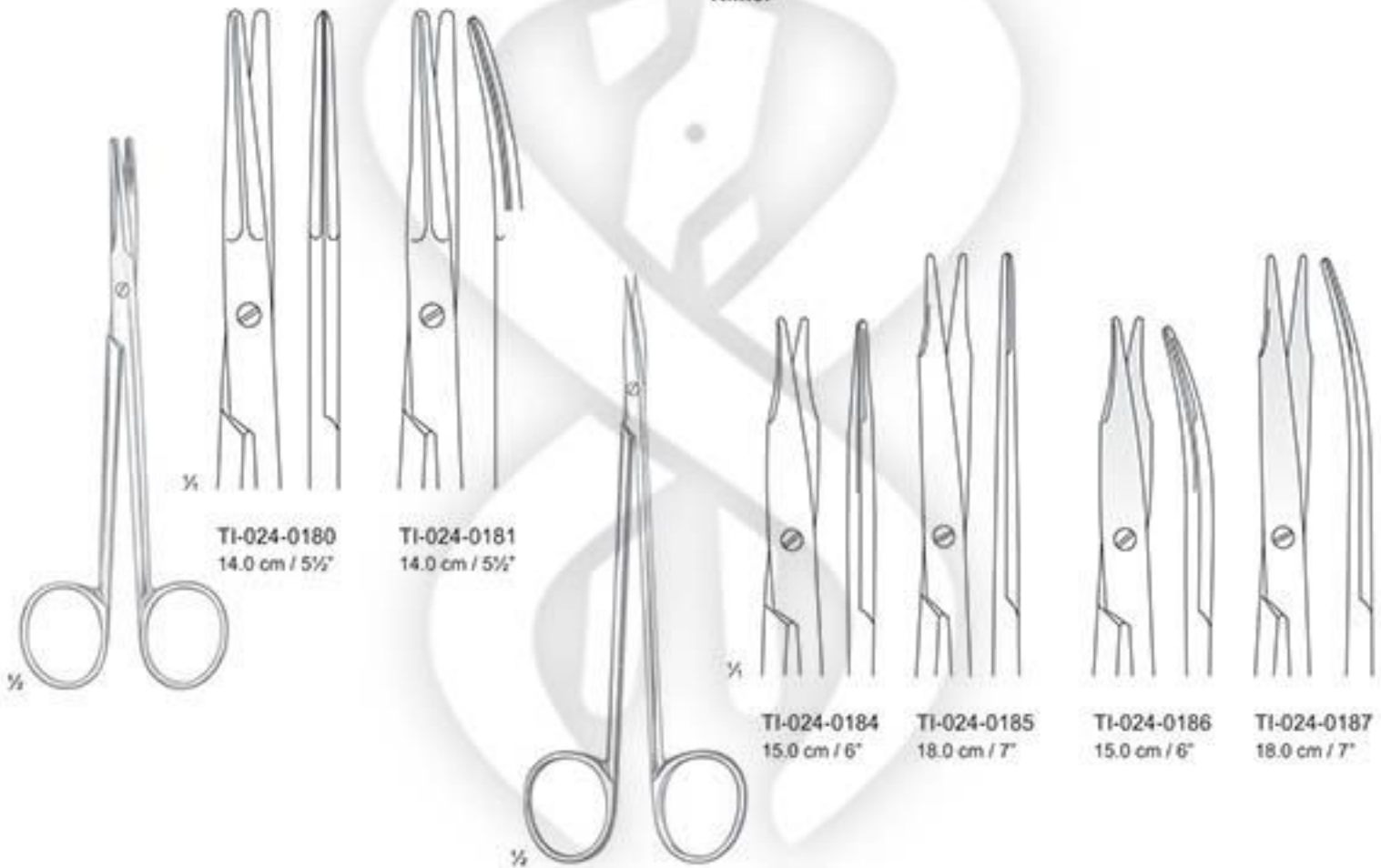

TI-024-0180
14.0 cm / 5 1/2"

TI-024-0181
14.0 cm / 5 1/2"

TI-024-0184
15.0 cm / 6"

TI-024-0185
18.0 cm / 7"

TI-024-0186
15.0 cm / 6"

TI-024-0187
18.0 cm / 7"

Reynolds

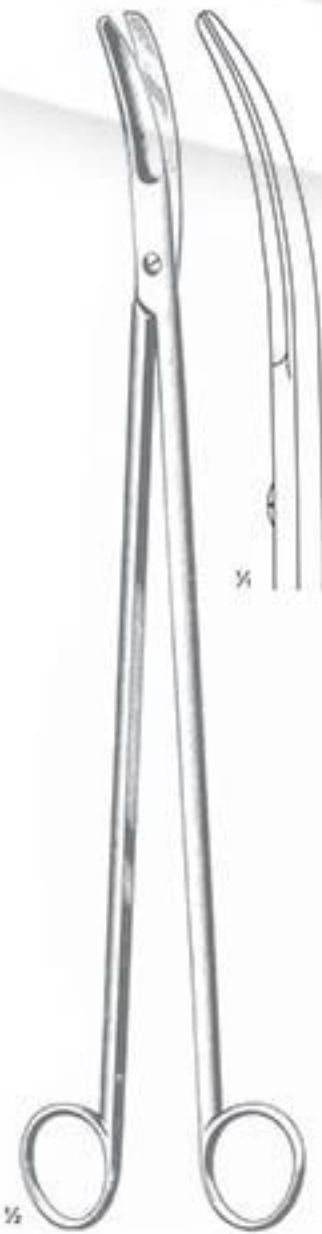

Crafoord
TI-025-0188
30.0 cm / 12"



Satinsky
TI-025-0189
24.5 cm / 10"



Klinkenbergh-Loth
TI-025-0190
23.0 cm / 9"

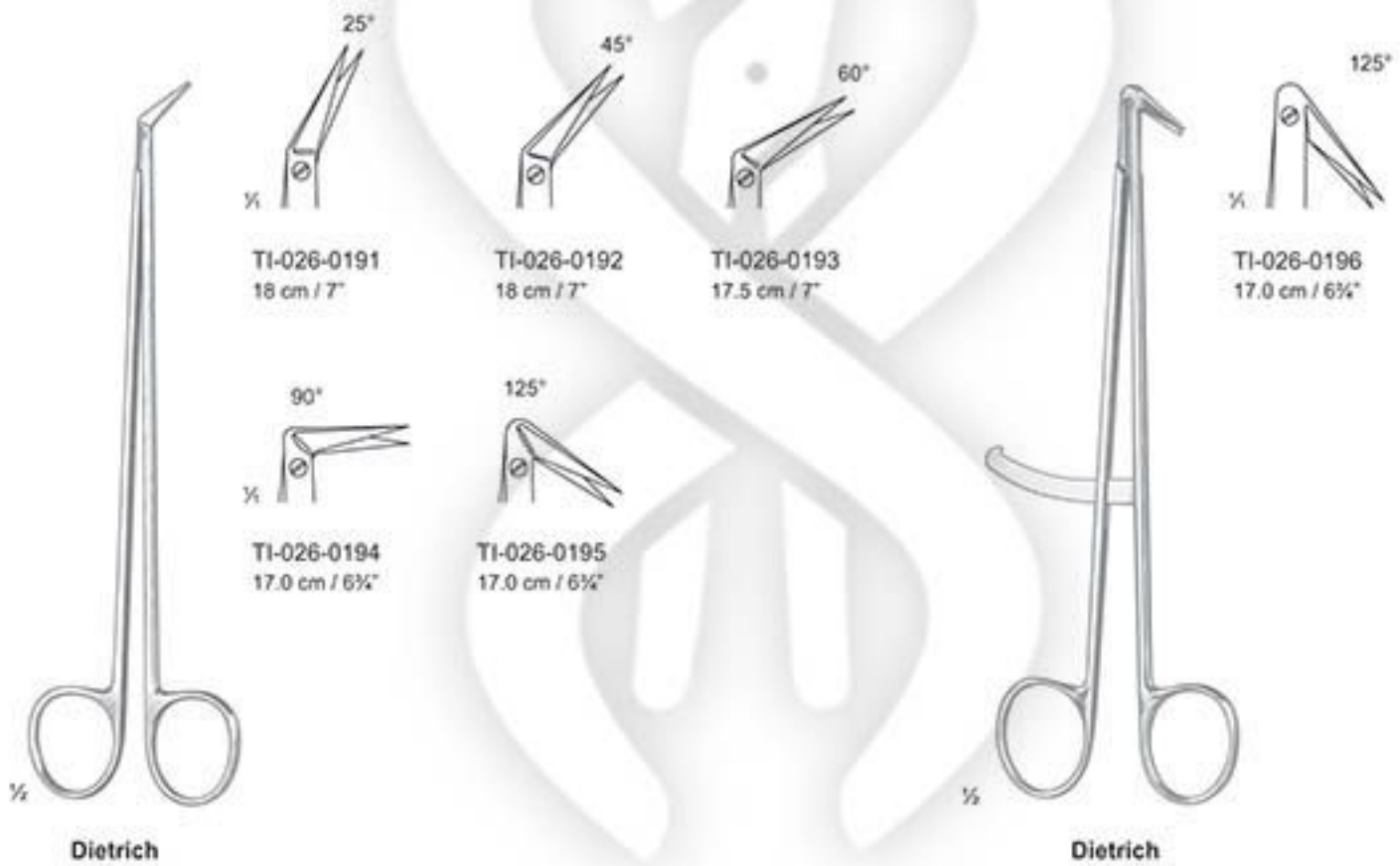



Potts-Smith



60°

1/2

TI-027-0197
19.0 cm / 7 1/2"

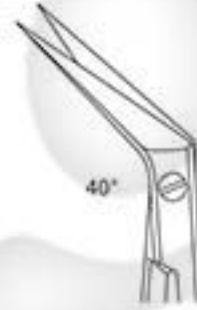

40°

TI-027-0198
19.0 cm / 7 1/2"



25°

TI-027-0199
19.0 cm / 7 1/2"



Potts de Martel



1/2

TI-027-0200
21.0 cm / 8 1/2"



TI-027-0201
24.0 cm / 9 1/2"



Mc Indoe

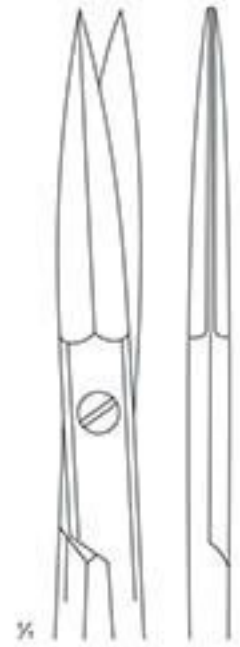

1/2

TI-027-0202
19.0 cm / 7 1/2"



Strully



TI-028-0203
22.0 cm / 8 1/2"
Neurosurgical Scissors



Dandy



TI-028-0204
17.0 cm / 6 3/4"
Neurosurgical Scissors

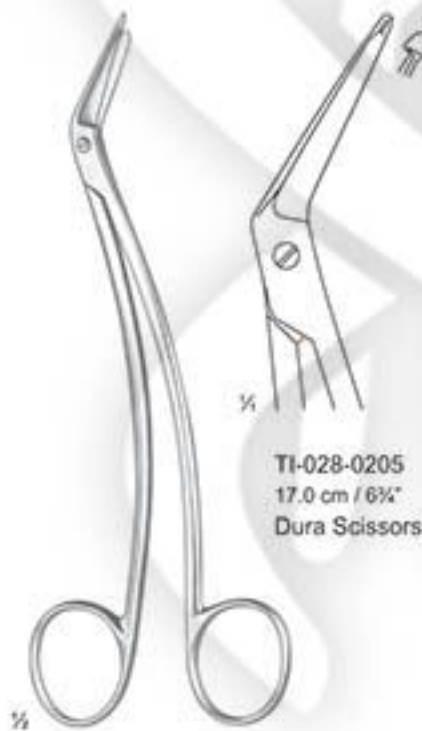

Schmieden-Taylor

TI-028-0205
17.0 cm / 6 3/4"
Dura Scissors



Toennis-Adson

TI-028-0206
17.5 cm / 7"
Dissecting Scissors

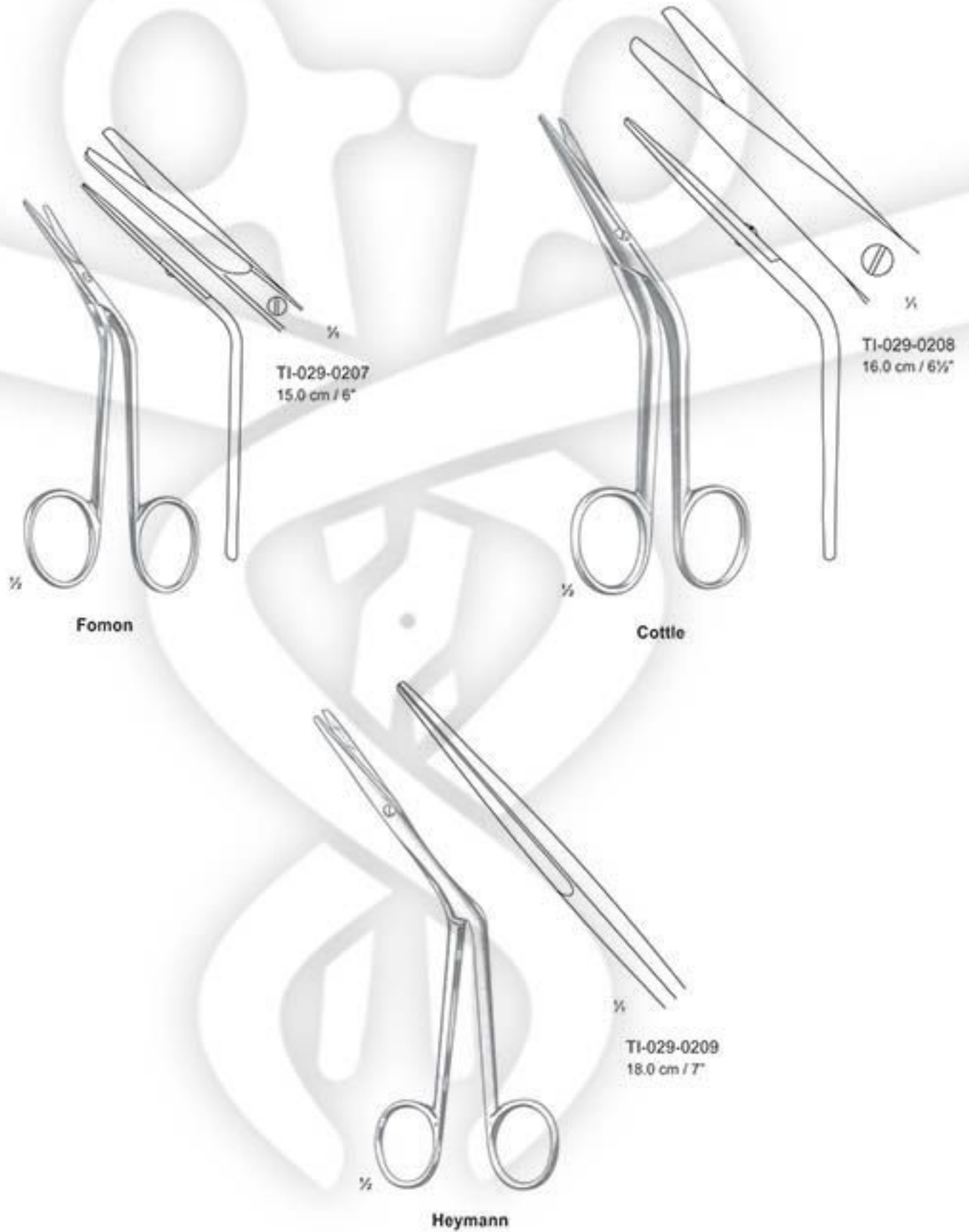

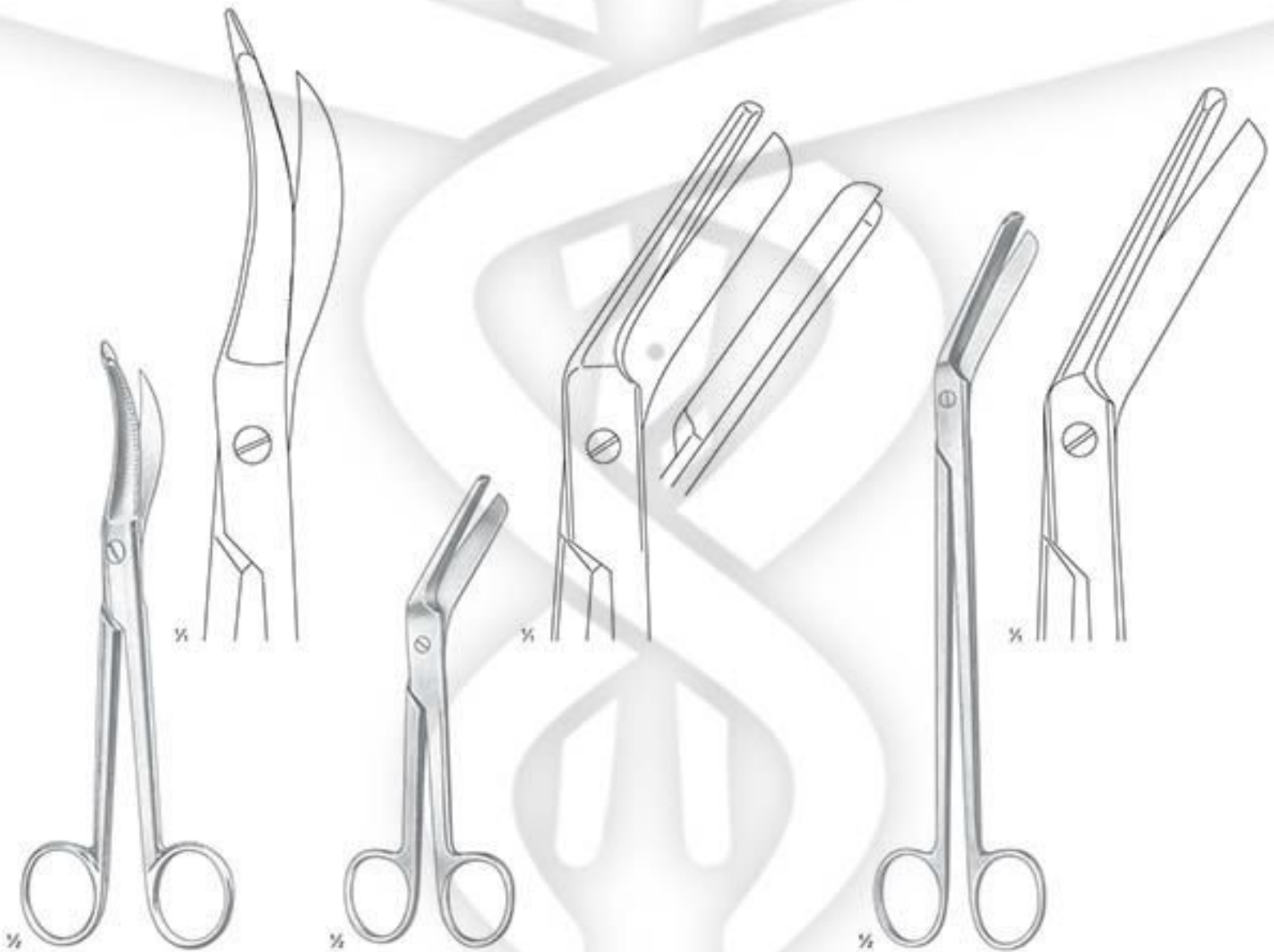

Waldmann
TI-030-0210
18.0 cm / 7"

Braun-Stadler
TI-030-0211
14.0 cm / 5½"

Braun-Stadler
TI-030-0212
22.0 cm / 8¾"



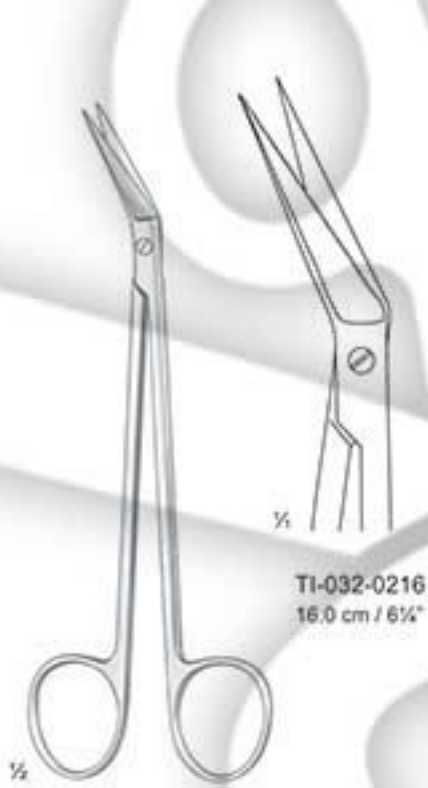

TI-032-0216
16.0 cm / 6 1/4"

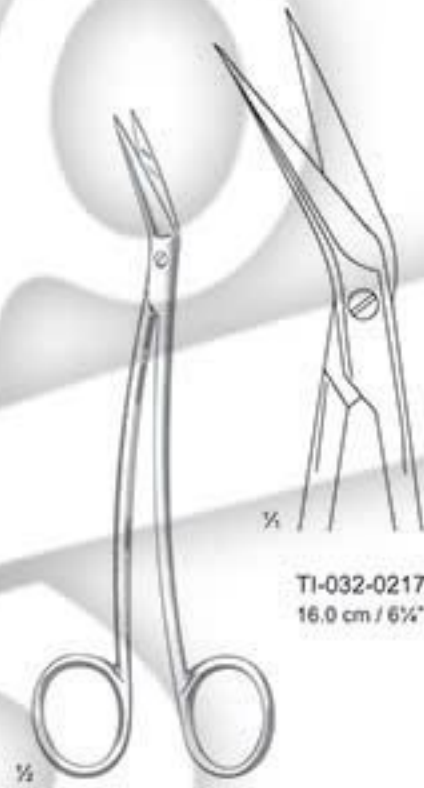

TI-032-0217
16.0 cm / 6 1/4"

Locklin



TI-032-0218
12.5 cm / 5"

Quinby

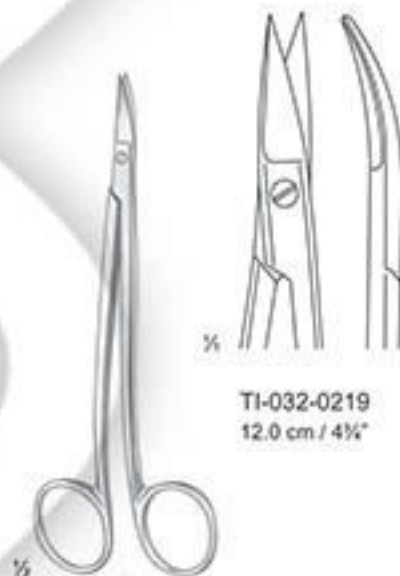

TI-032-0219
12.0 cm / 4 3/4"

Neumann



TI-033-0221
11.5 cm / 4 1/2"



TI-033-0222
11.5 cm / 4 1/2"



TI-033-0223
11.5 cm / 4 1/2"



TI-033-0224
11.5 cm / 4 1/2"



TI-033-0225
12.0 cm / 4 3/4"



TI-033-0226
12.0 cm / 4 3/4"





Spencer
TI-035-0238
9.0 cm / 3½"

Spencer
TI-035-0239
13.0 cm / 5"

Littauer
TI-035-0240
14.0 cm / 5½"

Universal
TI-035-0241
12.0 cm / 4¾"

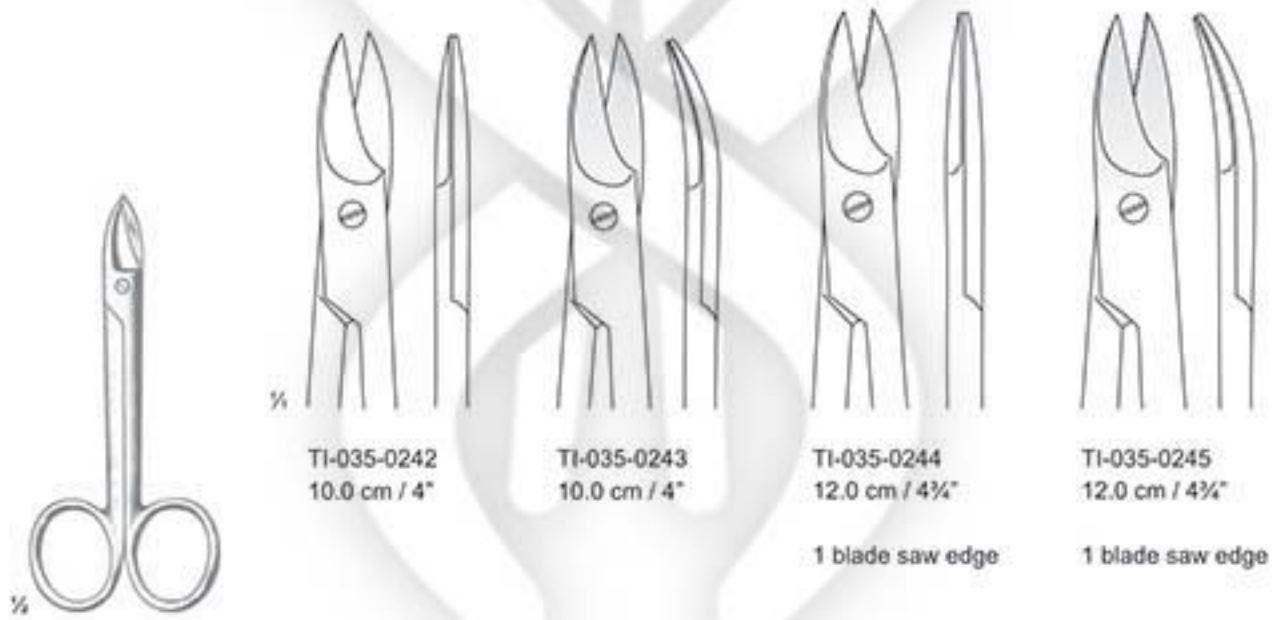

TI-035-0242
10.0 cm / 4"

TI-035-0243
10.0 cm / 4"

TI-035-0244
12.0 cm / 4¾"

TI-035-0245
12.0 cm / 4¾"

1 blade saw edge

1 blade saw edge

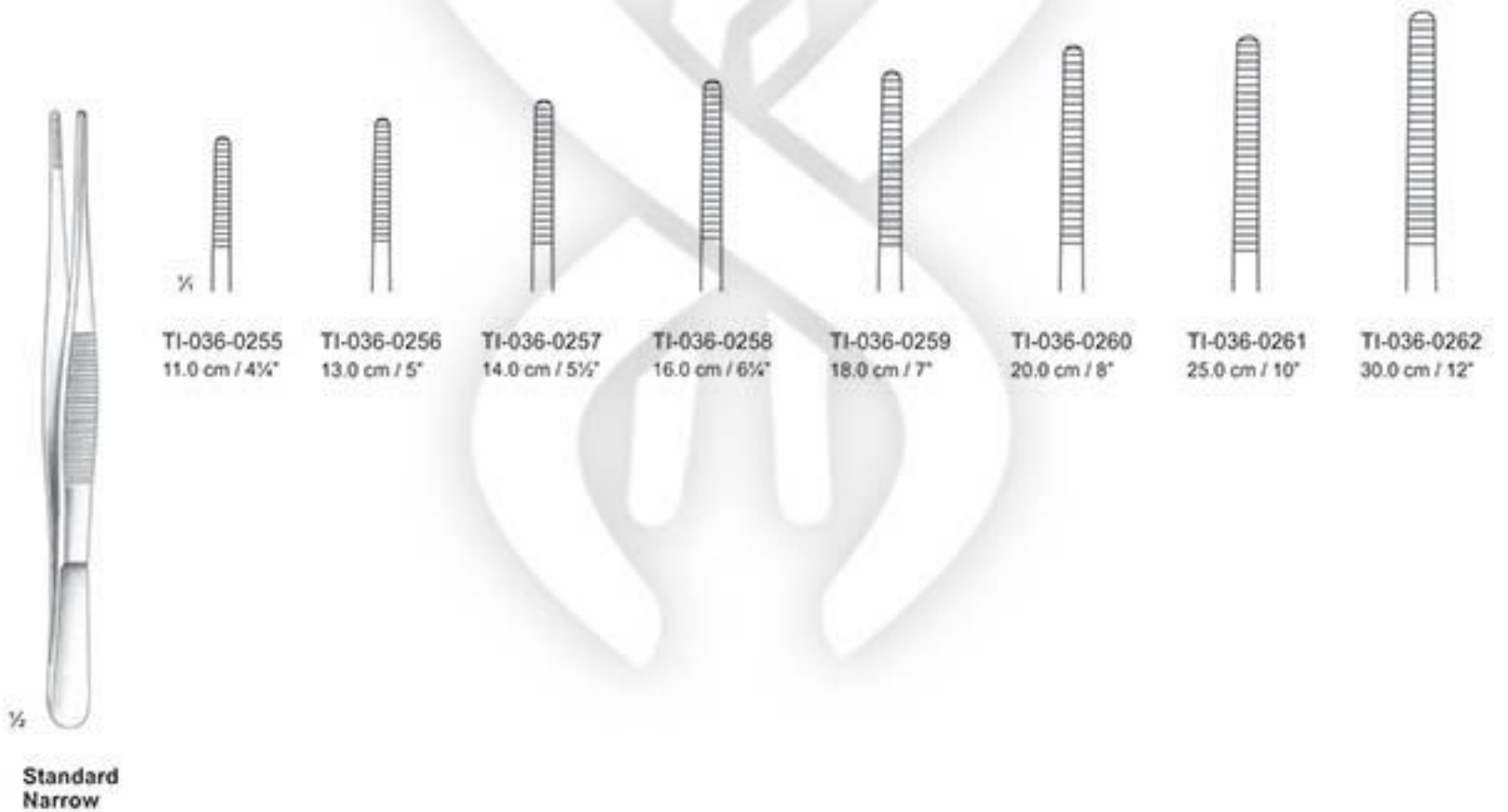
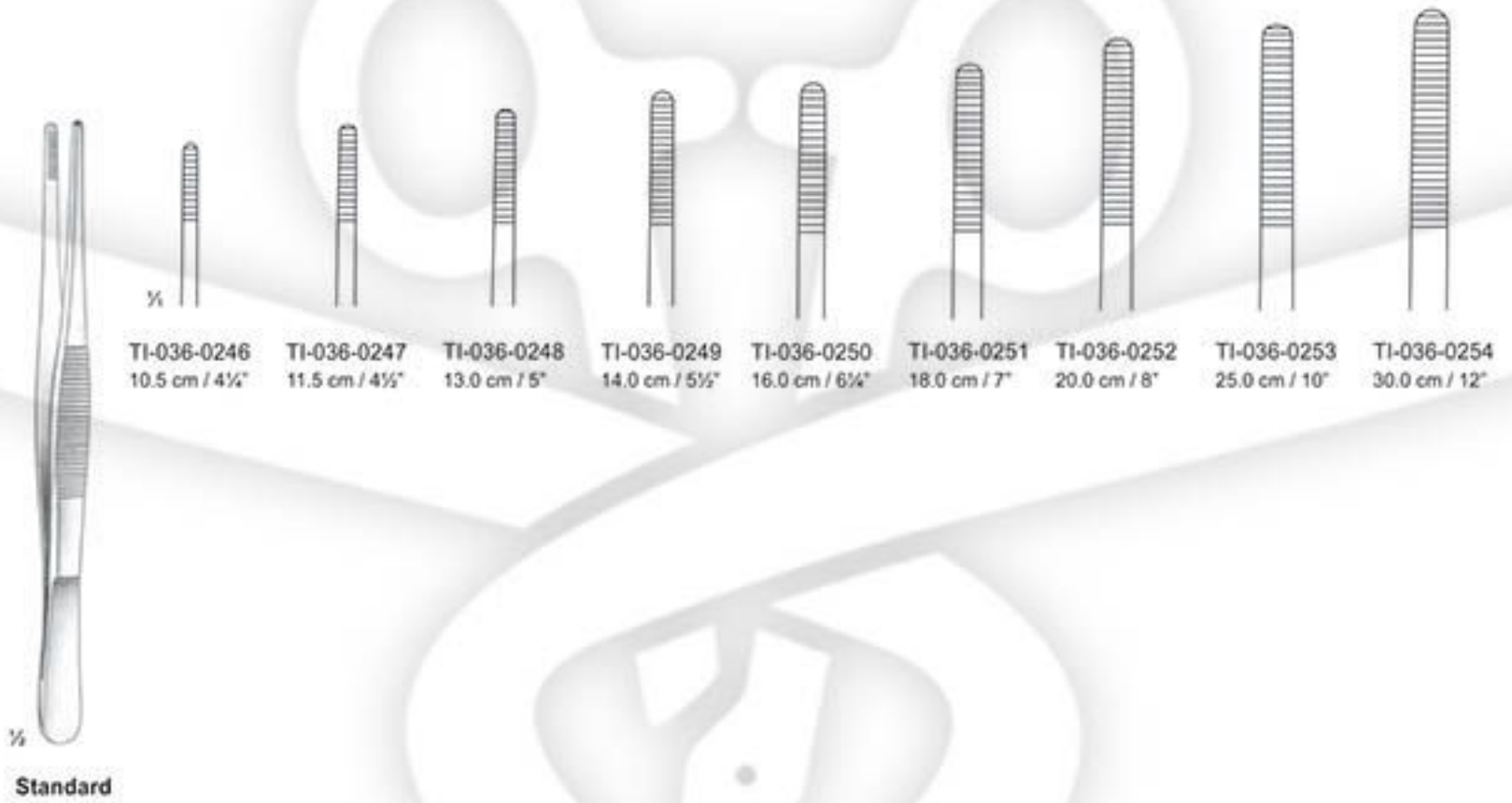



1/2

Standard



TI-037-0263
12.0 cm / 4 3/4"



TI-037-0264
13.0 cm / 5"



TI-037-0265
14.0 cm / 5 1/2"



TI-037-0266
15.0 cm / 6"



TI-037-0267
18.0 cm / 7"



TI-037-0268
21.0 cm / 8 1/2"



TI-037-0269
25.0 cm / 10"



TI-037-0270
31.0 cm / 12 1/2"



1/2

Standard
Narrow



TI-037-0271
12.0 cm / 4 3/4"



TI-037-0272
13.0 cm / 5"



TI-037-0273
14.0 cm / 5 1/2"



TI-037-0274
15.0 cm / 6"



1/2

Adson



TI-037-0275
12.0 cm / 4 3/4"



TI-037-0276
15.0 cm / 6"



1/2

McIndoe



TI-037-0277
15.0 cm / 6"



TI-038-0278
12.5 cm / 5"

TI-038-0279
15.0 cm / 6"

Semken



TI-038-0280
17.0 cm / 6 3/4"

Taylor



TI-038-0281
17.5 cm / 7"

Taylor



TI-038-0282
18.5 cm / 7 1/4"

Taylor



TI-038-0283
0.6 mm

TI-038-0284
0.8 mm

TI-038-0285
1.0 mm

15.5 cm / 6"
with dissector

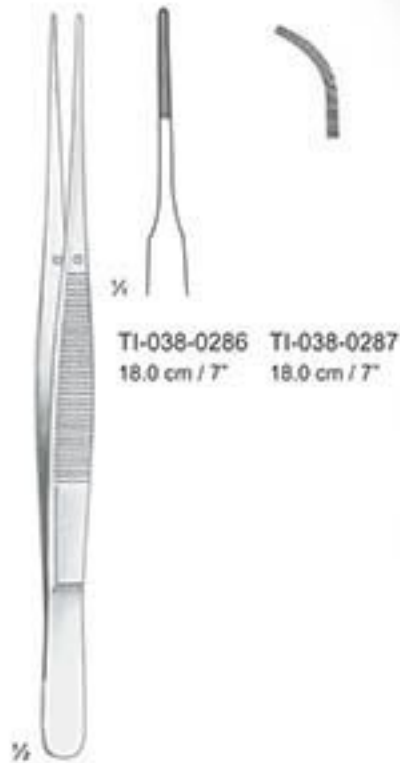

TI-038-0286
18.0 cm / 7"

TI-038-0287
18.0 cm / 7"

Gerald

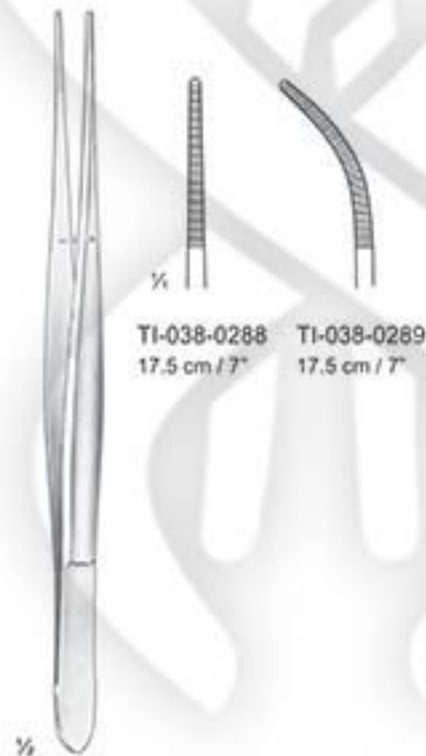

TI-038-0288
17.5 cm / 7"

TI-038-0289
17.5 cm / 7"

Cushing

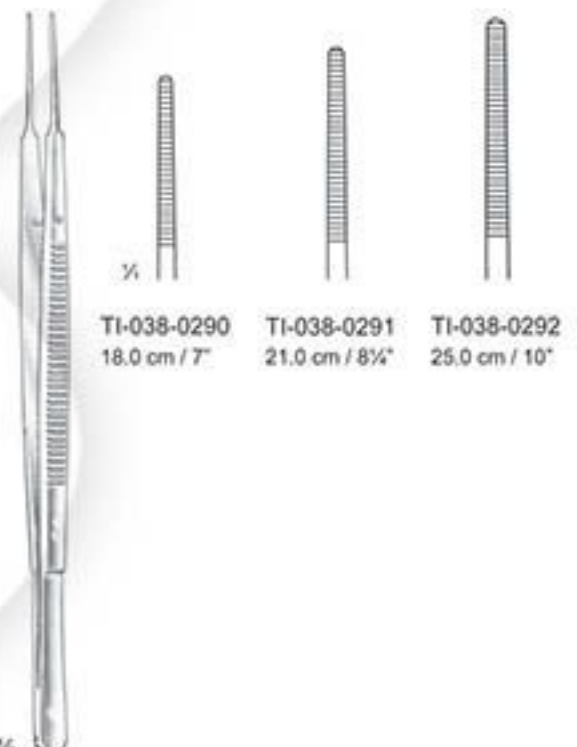

TI-038-0290
18.0 cm / 7"









TI-038-0291
21.0 cm / 8 1/4"

TI-038-0292
25.0 cm / 10"

Potts-Smith









1x2 Teeth

								
TI-039-0293 10.5 cm / 4 1/4"	TI-039-0294 11.5 cm / 4 1/2"	TI-039-0295 13.0 cm / 5"	TI-039-0296 14.0 cm / 5 1/2"	TI-039-0297 16.0 cm / 6 1/4"	TI-039-0298 18.0 cm / 7"	TI-039-0299 20.0 cm / 8"	TI-039-0300 25.0 cm / 10"	TI-039-0301 30.0 cm / 12"



2x3 Teeth

						
TI-039-0302 11.5 cm / 4 1/4"	TI-039-0303 13.0 cm / 5"	TI-039-0304 14.0 cm / 5 1/2"	TI-039-0305 16.0 cm / 6 1/4"	TI-039-0306 18.0 cm / 7"	TI-039-0307 20.0 cm / 8"	TI-039-0308 25.0 cm / 10"

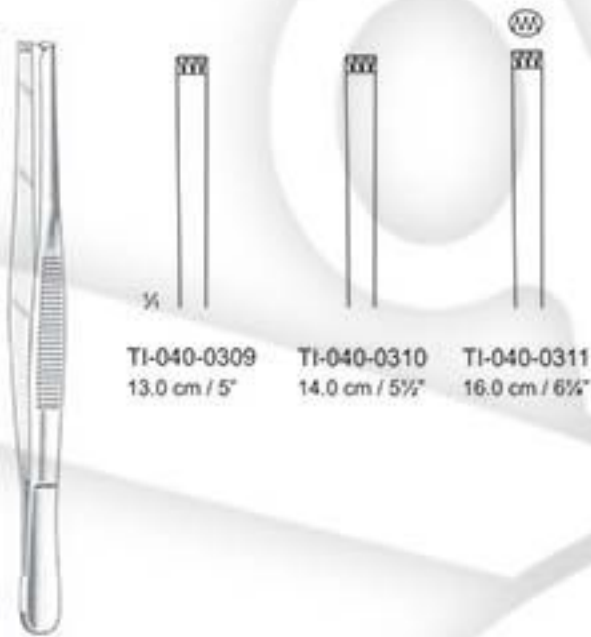

$\frac{3}{4}$			
TI-040-0309	TI-040-0310	TI-040-0311	
13.0 cm / 5"	14.0 cm / 5½"	16.0 cm / 6"	

3x4 Teeth

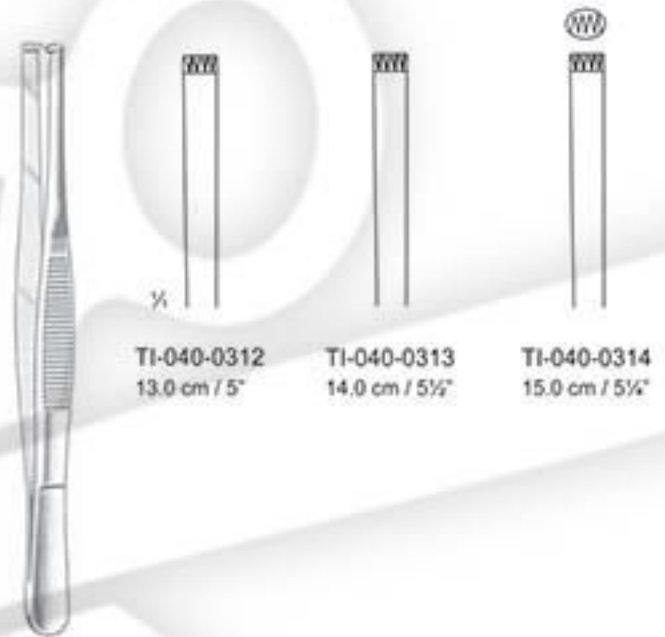

$\frac{3}{4}$			
TI-040-0312	TI-040-0313	TI-040-0314	
13.0 cm / 5"	14.0 cm / 5½"	15.0 cm / 5½"	

4x5 Teeth

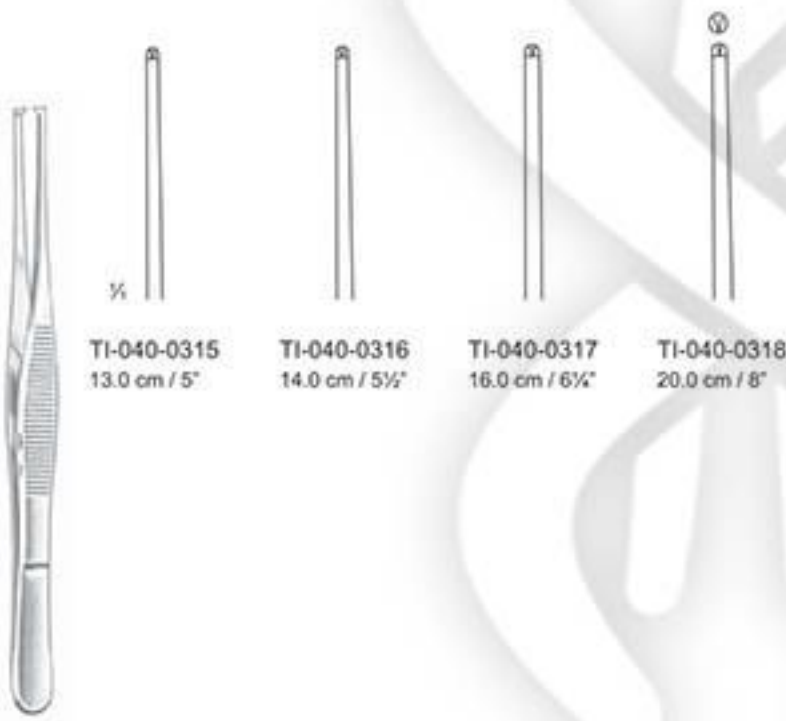

$\frac{3}{4}$				
TI-040-0315	TI-040-0316	TI-040-0317	TI-040-0318	
13.0 cm / 5"	14.0 cm / 5½"	16.0 cm / 6"	20.0 cm / 8"	

$\frac{3}{4}$
1x2 Teeth



$\frac{3}{4}$	
TI-040-0319	TI-040-0320
13.0 cm / 5"	14.0 cm / 5½"

$\frac{3}{4}$
1x2 Teeth



TI-041-0321
15.0 cm / 6"
4x5 Teeth

Stone



TI-041-0322
15.0 cm / 6"
5x6 Teeth

Lerche



TI-041-0323
15.0 cm / 6"
2x3 Teeth

Adlerkreutz



TI-041-0324
20.0 cm / 8"
2x3 Teeth



TI-041-0325
15.0 cm / 6"
4x5 Teeth



TI-041-0326
20.0 cm / 8"
4x5 Teeth



TI-041-0327
25.0 cm / 10"
4x5 Teeth



Adson
1x2 Teeth



TI-041-0328
12.0 cm / 1/2"



TI-041-0329
15.0 cm / 6"



Gillies
1x2 Teeth



TI-041-0330
15.0 cm / 6"

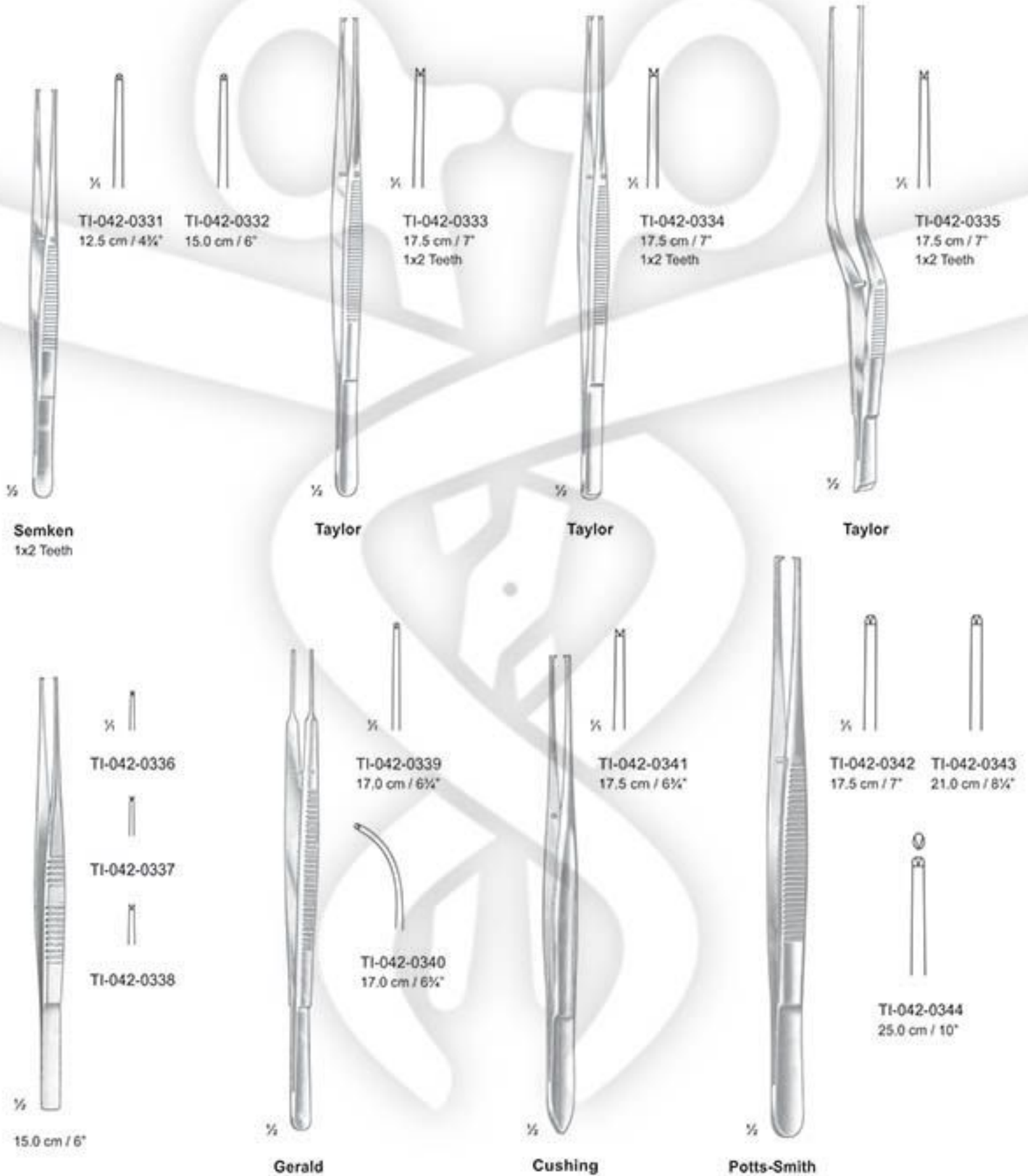



Brophy



TI-043-0345
20.0 cm / 8"



Adson-Brown



TI-043-0346
12.0 cm / 4 1/2"



Micro-Adson



TI-043-0347
12.0 cm / 4 1/2"



Micro-Adson



TI-043-0348
12.0 cm / 1/2"



Micro-Adson



TI-043-0349
11.0 cm / 4 1/8"
Teeth Extremely
Delicate



Duval



TI-043-0350
14.0 cm / 5 1/2"



Russ. Modell



TI-043-0351
15.0 cm / 6"



TI-043-0352
20.0 cm / 8"



TI-043-0353
25.0 cm / 10"



1/2

Bonney
18.0 cm / 7"



1/2

TI-044-0354
1x2 Teeth



TI-044-0355
2x3 Teeth

Grasping Forceps



1/2

Mayo-Russ



1/2

TI-044-0358
23.0 cm / 9"



1/2

Ferris-Smith
18.0 cm / 7"



1/2

TI-044-0356
1x2 Teeth



TI-044-0357
2x3 Teeth



1/2

Yasargil



1/2

Yasargil



1/2

Heifetz

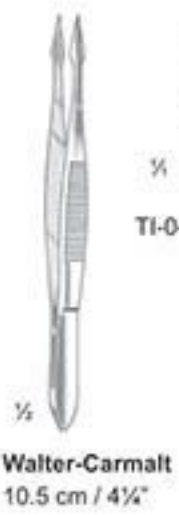
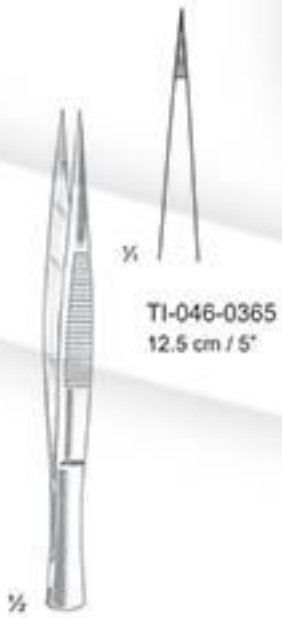



Shaaf
TI-047-0376
9.0 cm / 3 1/2"



Littauer
TI-047-0377
8.5 cm / 3 1/2"



TI-047-0378
9.0 cm / 3 1/2"



Douglas
TI-047-0379
9.0 cm / 3 1/2"



Douglas
TI-047-0380
9.0 cm / 3 1/2"



TI-048-0381
6.0 cm / 2 1/2"

TI-048-0384
6.0 cm / 2 1/2"



TI-048-0382
3.5 cm / 1 1/2"



TI-048-0385
3.5 cm / 1 1/2"



TI-048-0383
5.0 cm / 2"



TI-048-0386
5.0 cm / 2"



Johns Hopkins



TI-048-0387
5.0 cm / 2"



TI-048-0388
6.5 cm / 2 1/2"



TI-048-0389
7.5 cm / 3"



Dieffenbach



TI-048-0390

TI-048-0391

TI-048-0392



TI-048-0393

TI-048-0394

TI-048-0395

	TI-048-0390	TI-048-0391	TI-048-0392		TI-048-0393	TI-048-0394	TI-048-0395
Lenght	50 mm	50 mm	60 mm		50 mm	50 mm	60 mm
Jaws	8 mm	12 mm	20 mm		8 mm	12 mm	20 mm
Weight	3 gr.	3 gr.	3 gr.		3 gr.	3 gr.	3 gr.
Pressure	50 gr.	50 gr.	50 gr.		50 gr.	50 gr.	50 gr.



1/2





Baby-Mixer



TI-050-0400
14.0 cm / 5½"



TI-050-0401
14.0 cm / 5½"



Hartmann



TI-050-0402
10 cm / 4"



TI-050-0403
10 cm / 4"



Cross Serrations



TI-050-0404
12.0 cm / 4¾"



Halsted-Mosquito



TI-050-0405
12.5 cm / 5"



TI-050-0406
14.0 cm / 5½"



TI-050-0407
12.5 cm / 5"



TI-050-0408
14.0 cm / 5½"



TI-050-040
12.5 cm / 5"



TI-050-0410
14.0 cm / 5½"
1x2 Teeth



TI-050-0411
12.5 cm / 5"



TI-050-0412
14.0 cm / 5½"



Halsted-Mosquito



TI-051-0413
18.0 cm / 7"



TI-051-0414
18.0 cm / 7"



TI-051-0415
18.0 cm / 7"
1x2 Teeth



TI-051-0416
18.0 cm / 7"
1x2 Teeth



TI-051-0417
21.0 cm / 8 1/4"



TI-051-0418
21.0 cm / 8 1/4"



TI-051-0419
21.0 cm / 8 1/4"
1x2 Teeth



TI-051-0420
21.0 cm / 8 1/4"
1x2 Teeth



Micro-Mosquito



TI-051-0421
10.0 cm / 4"



TI-051-0422
12.0 cm / 4 1/4"



TI-051-0423
10.0 cm / 4"



TI-051-0424
12.0 cm / 4 1/4"



TI-051-0425
10.0 cm / 4"
1x2 Teeth



TI-051-0426
12.0 cm / 4 1/4"
1x2 Teeth



TI-051-0427
10.0 cm / 4"
1x2 Teeth



TI-051-0428
12.0 cm / 4 1/4"
1x2 Teeth



Providence-Hospital



TI-052-0429
14.0 cm / 5½"



TI-052-0430
14.0 cm / 5½"



Kelly



TI-052-0431
14.0 cm / 5½"



TI-052-0432
14.0 cm / 5½"



Leriche



TI-052-0433
15.0 cm / 6"



TI-052-0434
15.0 cm / 6"



TI-052-0435
15.0 cm / 6"
1x2 Teeth



TI-052-0436
15.0 cm / 6"
1x2 Teeth



Rankin-Kelly

TI-053-0437
16.0 cm / 6 $\frac{1}{4}$ "



TI-053-0438
16.0 cm / 6 $\frac{1}{4}$ "



Baby-Overholt

TI-053-0439
13.5 cm / 5 $\frac{1}{4}$ "



Crile

TI-053-0440
14.0 cm / 5 $\frac{1}{2}$ "



TI-053-0441
14.0 cm / 5 $\frac{1}{2}$ "

TI-053-0442
14.0 cm / 5 $\frac{1}{2}$ "
1x2 Teeth



TI-053-0443
14.0 cm / 5 $\frac{1}{2}$ "
1x2 Teeth



Rankin-Crile



TI-054-0444
16.0 cm / 6 1/4"



TI-054-0445
16.0 cm / 6 1/4"



Lovlace



TI-054-0446



TI-054-0447
1x2 Teeth



Mosquito-Dandy



TI-054-0448
12.0 cm / 4 3/4"

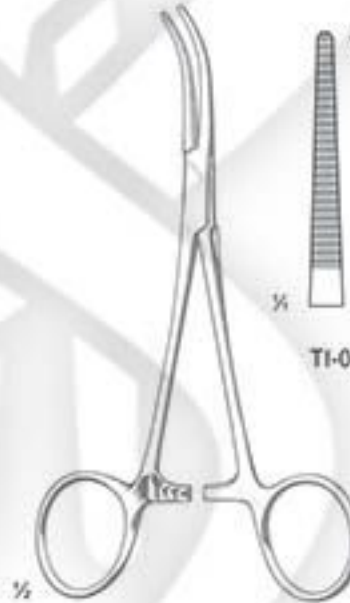

Dandy



TI-054-0449

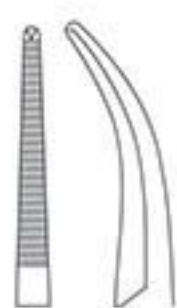

TI-054-0450
1X2 Teeth



Adson



TI-055-0451
18.5 cm / 7 1/4"
1x2 Teeth



TI-055-0452
18.5 cm / 7 1/4"
1x2 Teeth



Rochester-Carmalt



TI-055-0453
16.0 cm / 6 1/4"



TI-055-0454
20.0 cm / 8"



TI-055-0455
16.0 cm / 6 1/4"



TI-055-0456
20.0 cm / 8"



Pean
Delicate Pattern

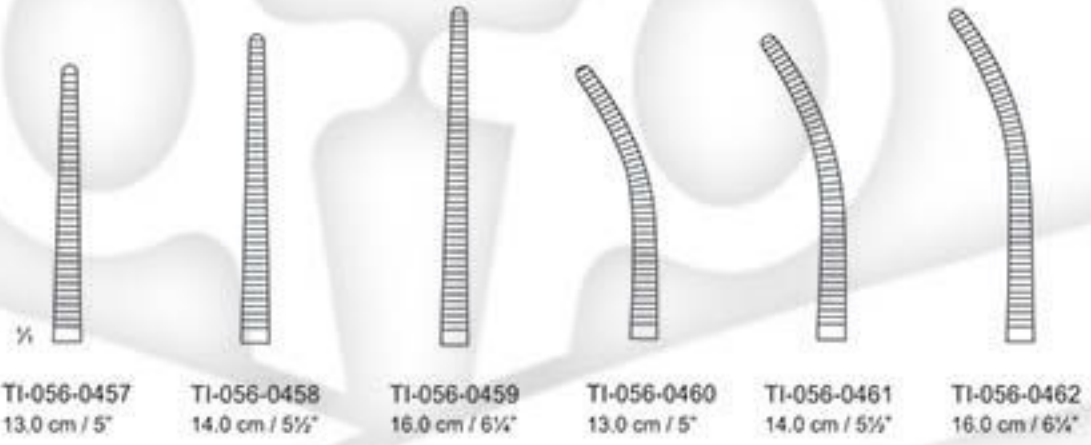

Kocher
Delicate Pattern

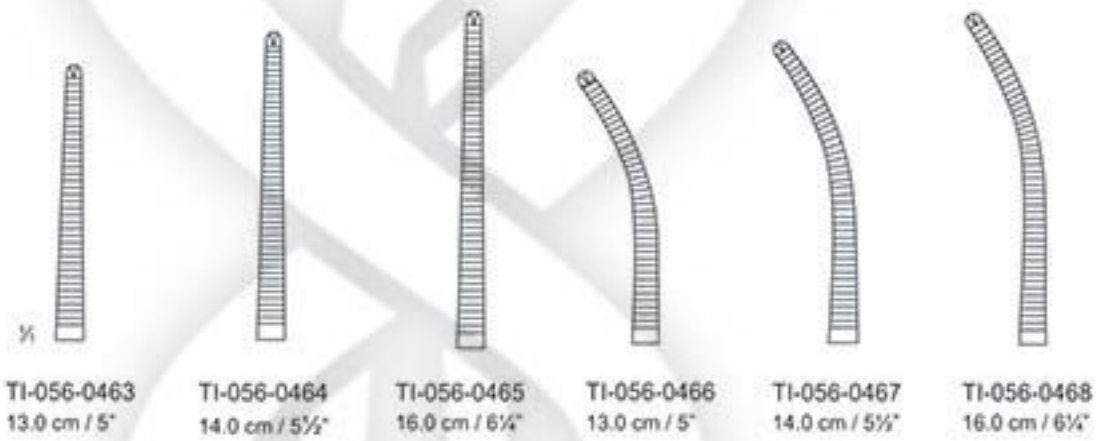

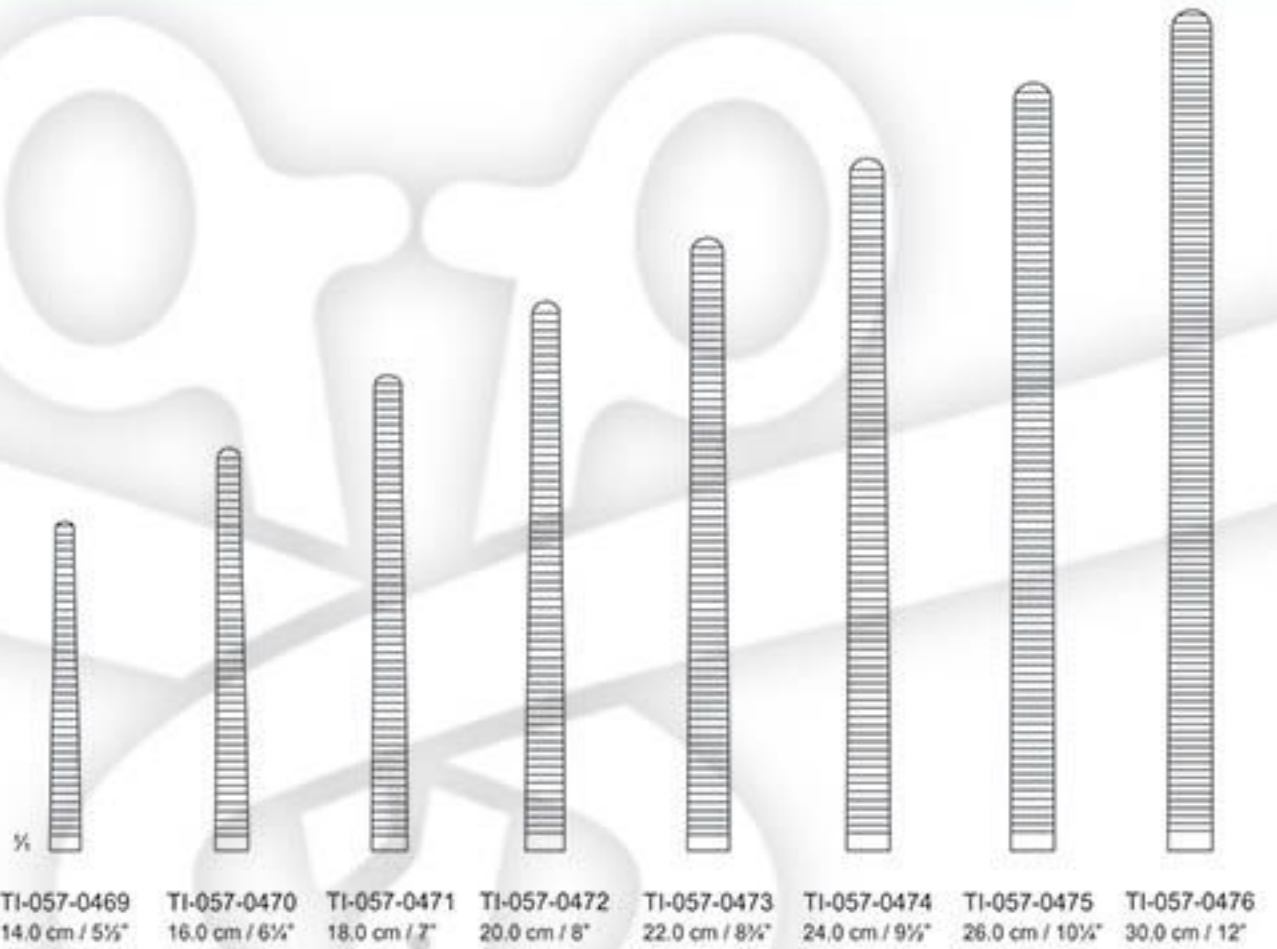

Rochester-Pean

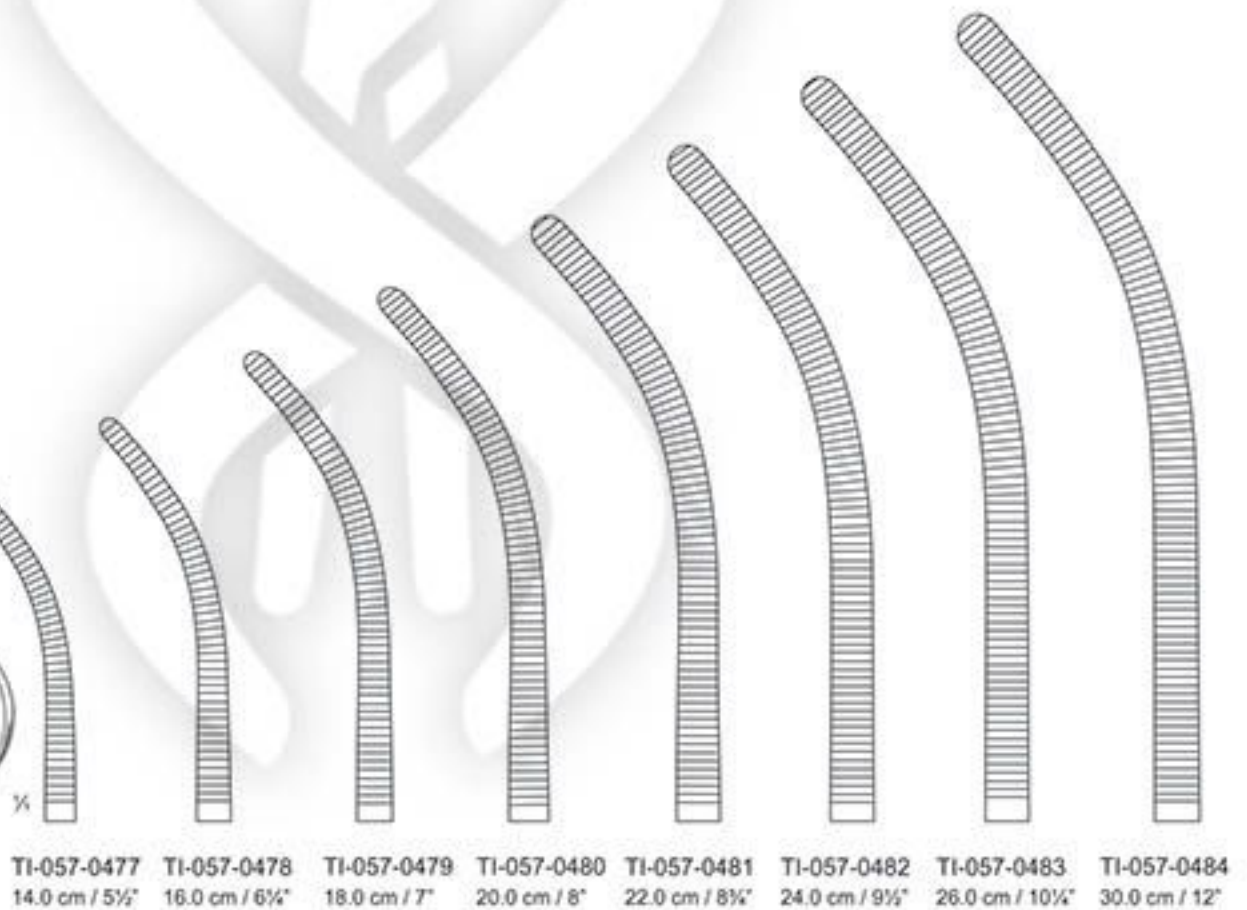

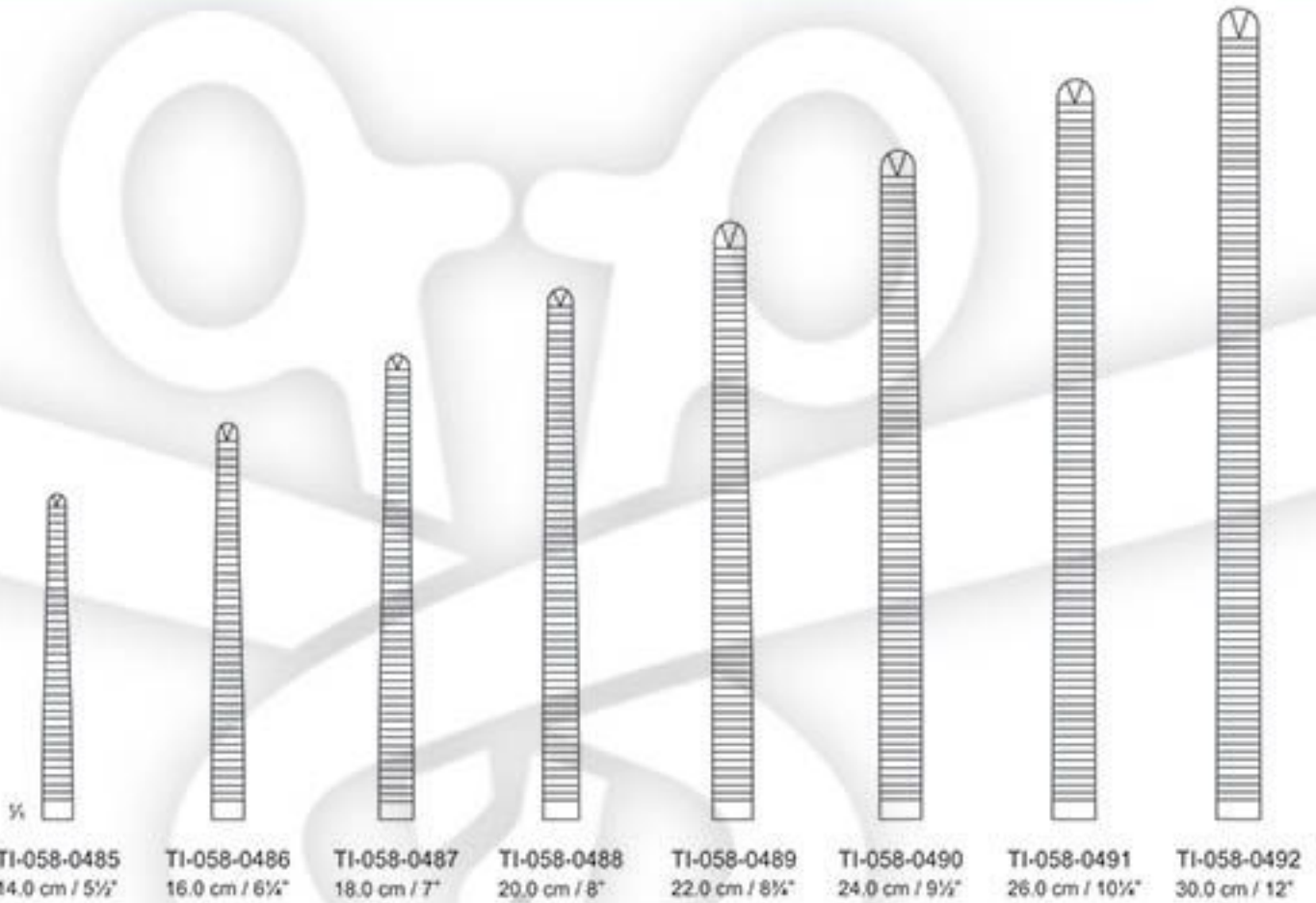

Kocher (Ochsner)
1x2 Teeth

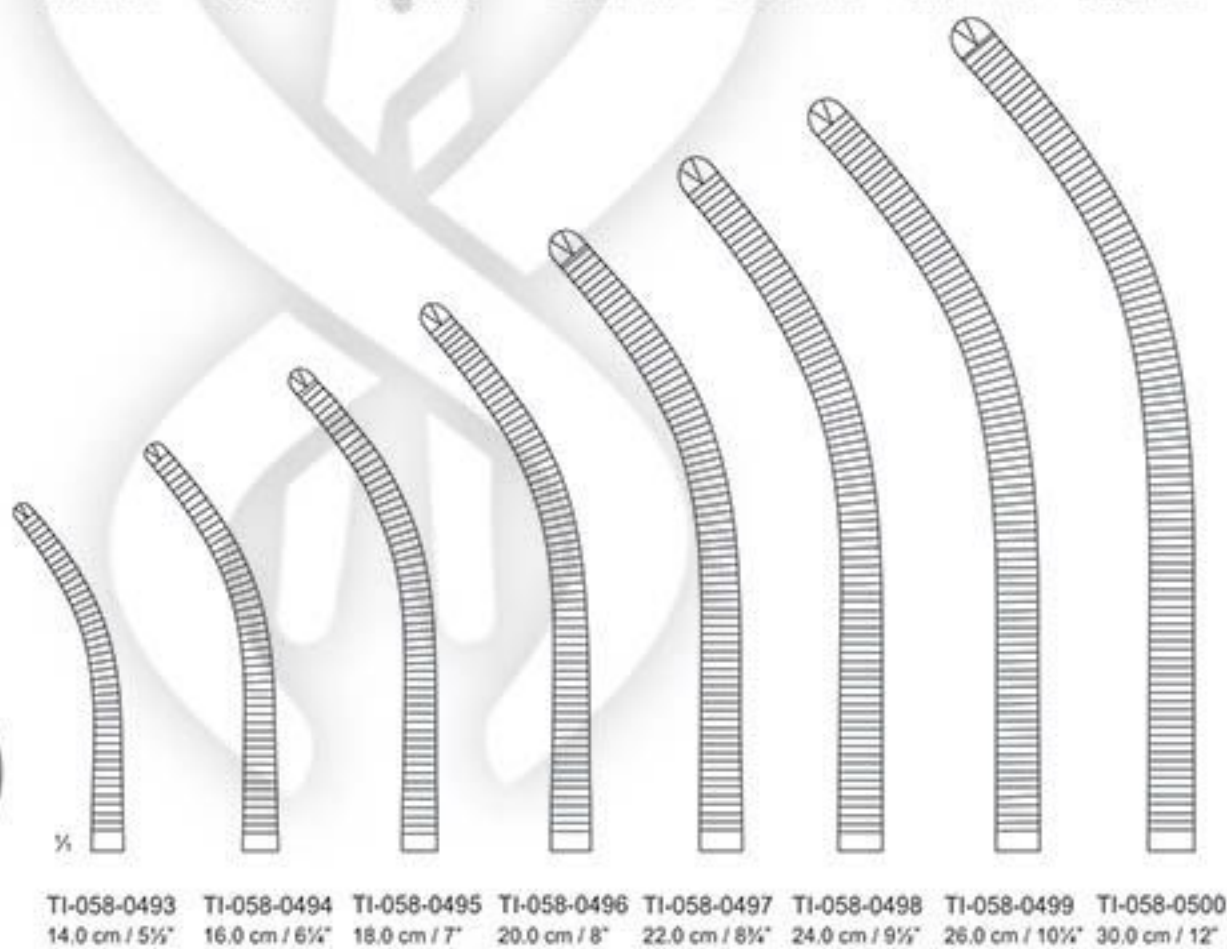



Baby-Mixer



1/8"

TI-059-0501
18.0 cm / 7"

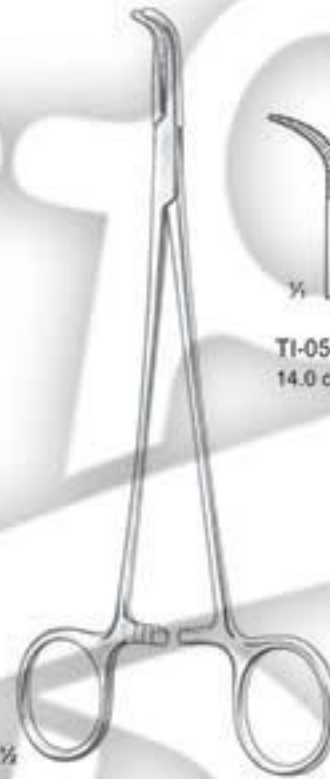

Baby-Adson



1/8"

TI-059-0502
14.0 cm / 5 1/2"



TI-059-0503
18.0 cm / 7"

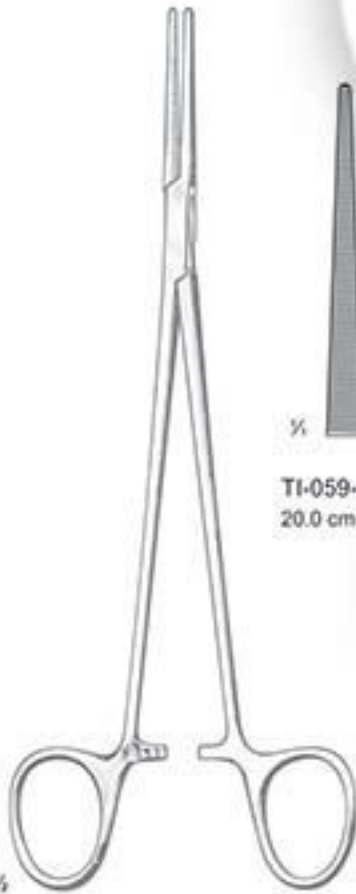

Heiss



1/8"

TI-059-0504
20.0 cm / 8"



TI-059-0505
20.0 cm / 8"



TI-059-0506
20.0 cm / 8"



Overholt-Mixer

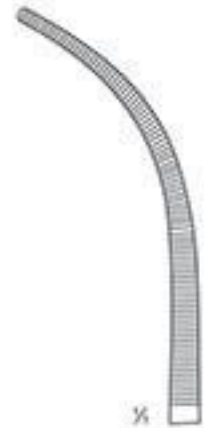

1/8"

TI-059-0507
21.0 cm / 8 1/4"

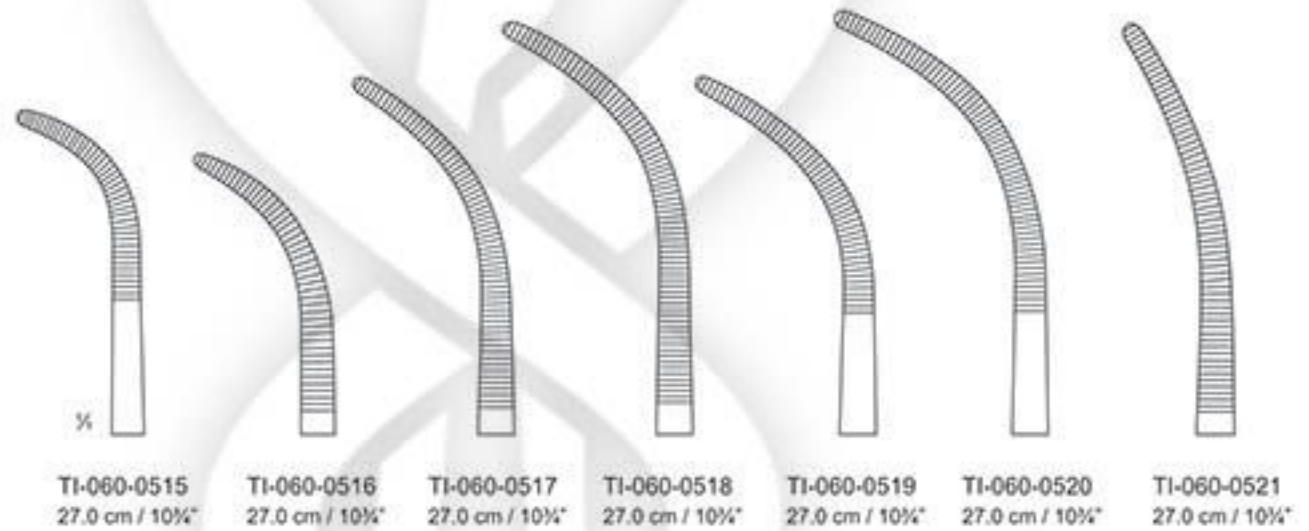
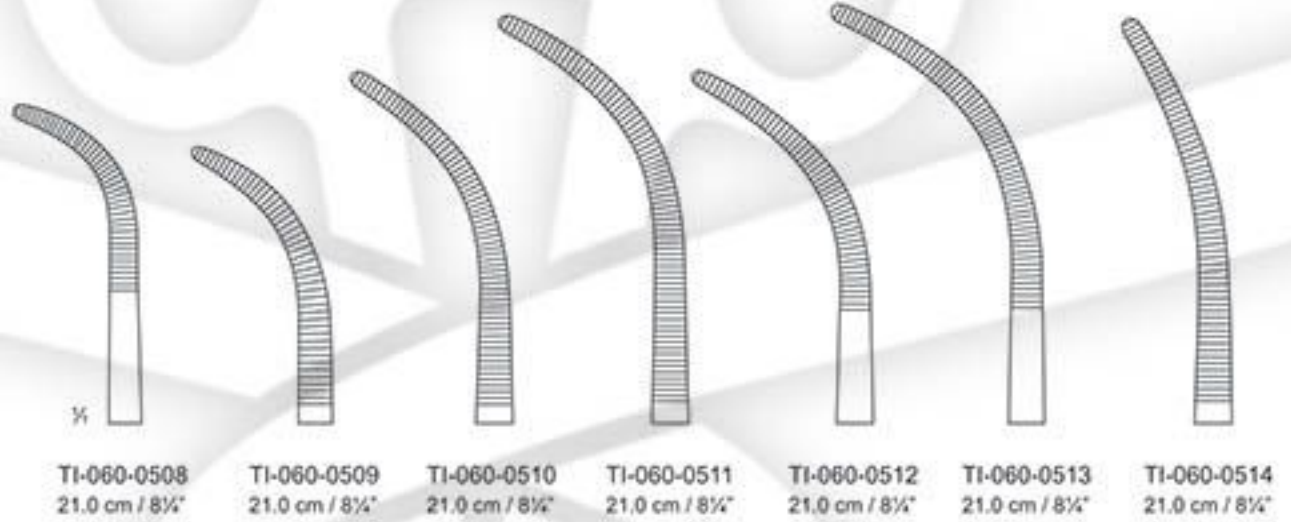

Overholt-Geissendoerfer



Mini-Gemini



TI-061-0522
18.0 cm / 7"



TI-061-0523
22.0 cm / 8 1/2"



TI-061-0524
25.0 cm / 10"



TI-061-0525
28.0 cm / 11"



Gemini



TI-061-0526
13.0 cm / 5"



TI-061-0527
16.0 cm / 6 1/4"



TI-061-0528
18.0 cm / 7"



TI-061-0529
20.0 cm / 8"



TI-061-0530
23.0 cm / 9"



TI-061-0531
25.0 cm / 10"



TI-061-0532
28.0 cm / 11"

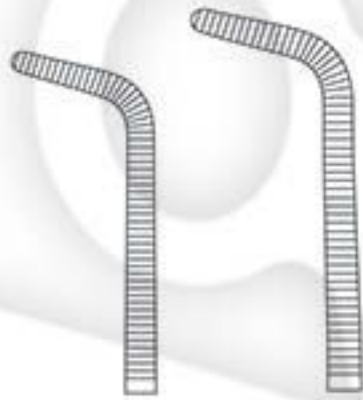

TI-062-0533
15.0 cm / 6"

TI-062-0534
18.0 cm / 7"



TI-062-0535
18.0 cm / 7"

Mixer-O'Shaugnessy

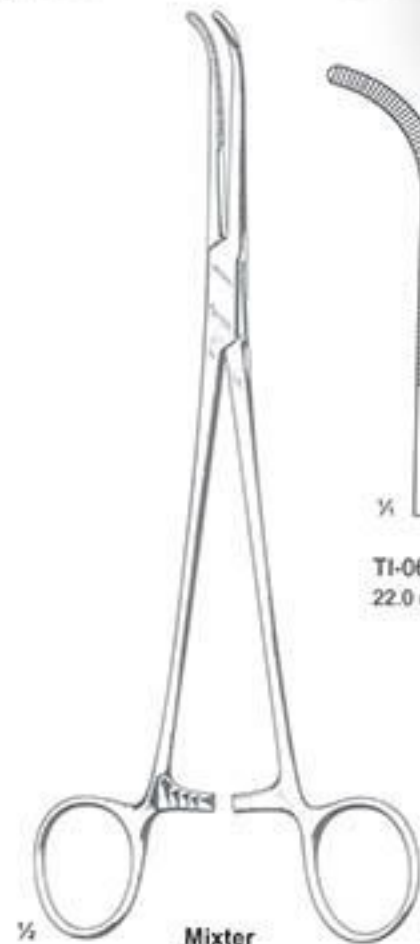

TI-062-0536
22.0 cm / 8 3/4"



TI-062-0537
23.0 cm / 9"

Mixer

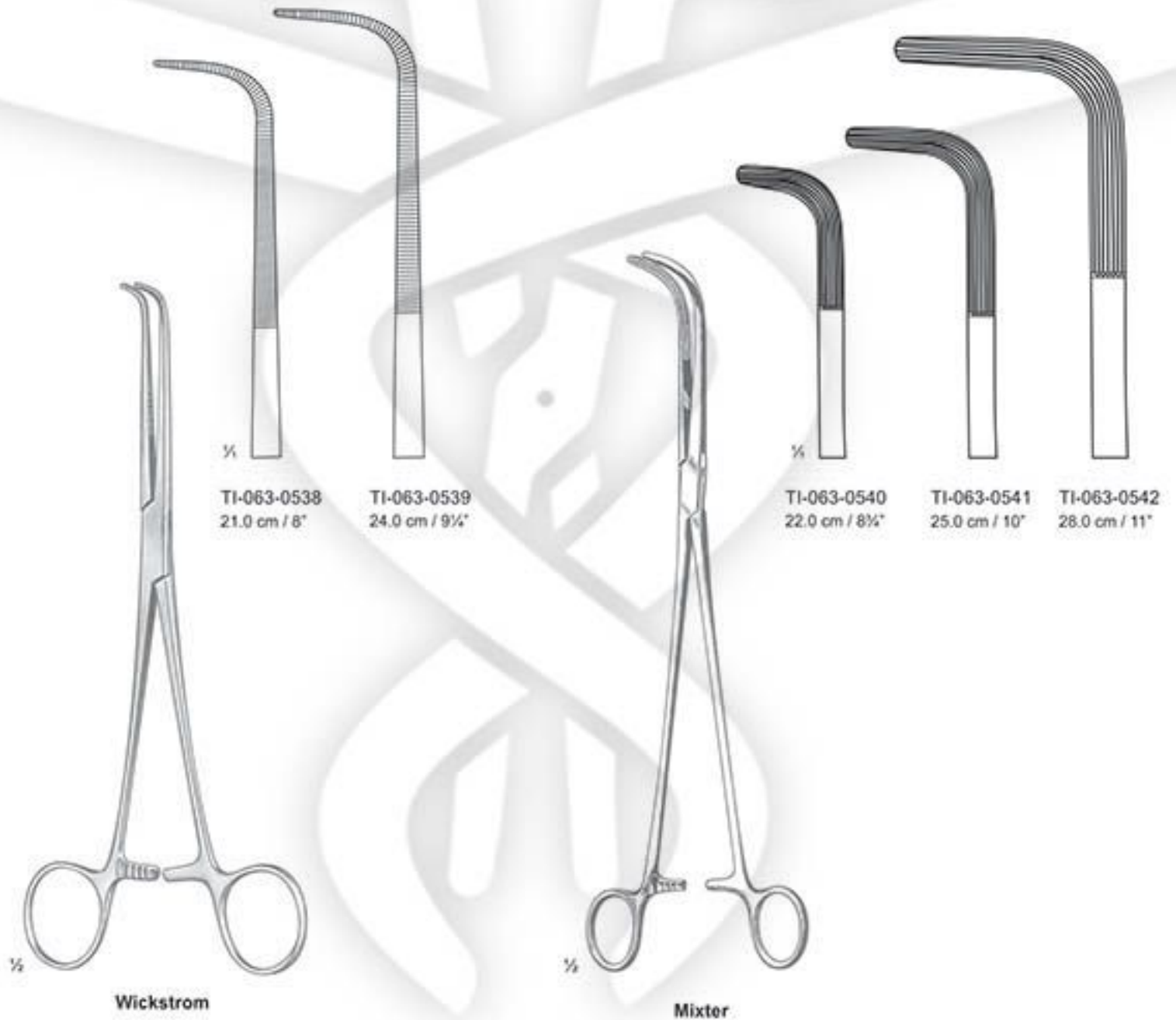



Mcquigg-Mixer



TI-064-0543
22.0 cm / 8 1/2"

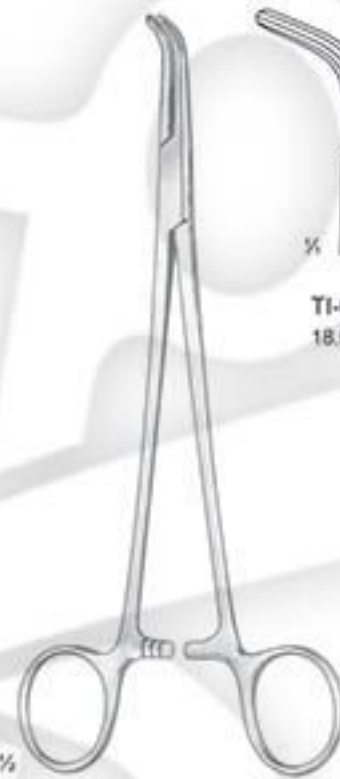

Lower



TI-064-0544
18.0 cm / 7"



Lahey



TI-064-0545
19.0 cm / 7 1/2"



TI-064-0546
23.0 cm / 9"



Finocchietto



TI-064-0547
24.0 cm / 9 1/2"







Desjardins

¼

TI-067-0554
21.0 cm / 8¼"



Negus

¼

TI-067-0555
19.0 cm / 7½"



TI-067-0556
19.0 cm / 7½"



Phaneuf
21.5 cm / 8½"
1x2 Teeth



TI-068-0557



TI-068-0558



TI-068-0559
19.0 cm / 7½"



TI-068-0560
21.0 cm / 8¼"



TI-068-0561
23.0 cm / 9"



Heaney



TI-068-0562
19.5 cm / 7¾"



TI-068-0563
21.0 cm / 8¼"



TI-068-0564
23.0 cm / 9"



Wertheim-Cullen

TI-069-0565
21.5 cm / 8½"



Wertheim

TI-069-0566
24.0 cm / 9½"
Extra Strong







TI-071-0570
22.0 cm / 8 1/2"
Slightly

TI-071-0571
23.0 cm / 9"
More Curved



TI-071-0572
22.0 cm / 8 1/2"
Slightly Curved

TI-071-0573
23.0 cm / 9"
More Curved

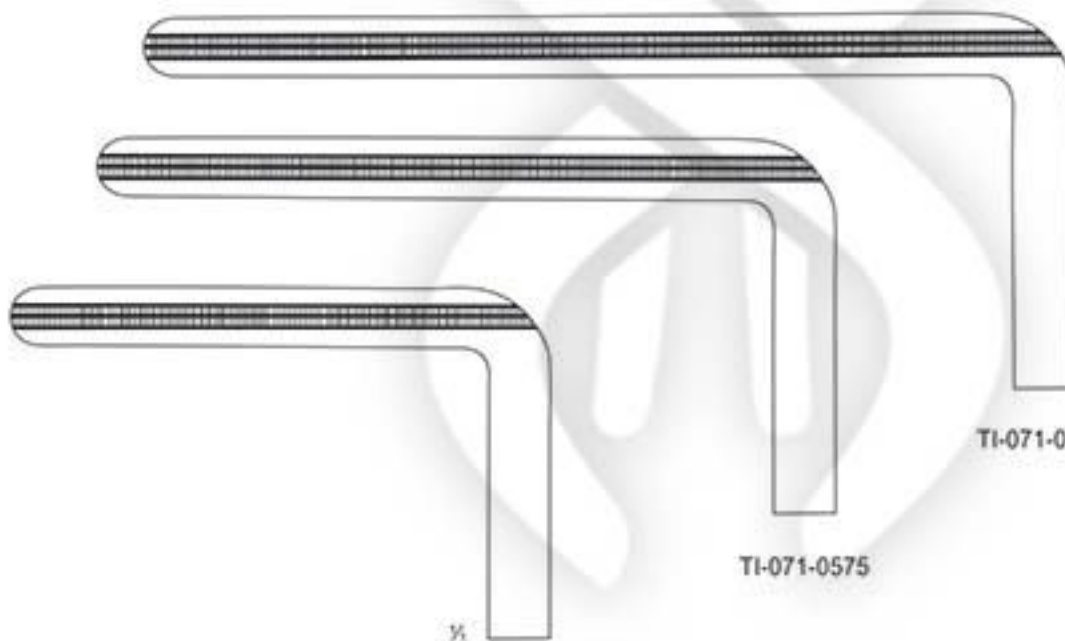

TI-071-0574

TI-071-0575

TI-071-0576



Wertheim
24.0 cm / 9 1/2"



1/2
Schaedel
TI-072-0577 09.0 cm / 3 1/2"



1/2
Jones
TI-072-0578 5.0 cm / 2"
TI-072-0579 9.0 cm / 3 1/2"



1/2
TI-072-0580 11.0 cm / 4 1/4"
TI-072-0581 13.0 cm / 5"
delicate pattern



1/2
Backhaus
TI-072-0582 8.0 cm / 3 1/4"
TI-072-0583 11.0 cm / 4 1/4"
TI-072-0584 13.0 cm / 5"
TI-072-0585 15.0 cm / 6"



1/2
Roeder
TI-072-0586 13.0 cm / 5"
TI-072-0587 15.0 cm / 6"



1/2
Lorna
TI-072-0588 10.0 cm / 4"
TI-072-0589 13.0 cm / 5"



Standard



1/4

TI-073-0590
15.0 cm / 6"



TI-073-0591
18.0 cm / 7"



TI-073-0592
20.0 cm / 8"



with safety guard



1/4

TI-073-0593
15.0 cm / 6"



TI-073-0594
18.0 cm / 7"



TI-073-0595
20.0 cm / 8"

Petit-Point Jacobson Mosquito Forceps

TI-074-0596 13.0 cm / 5" - Straight

TI-074-0597 13.0 cm / 5" - Curved

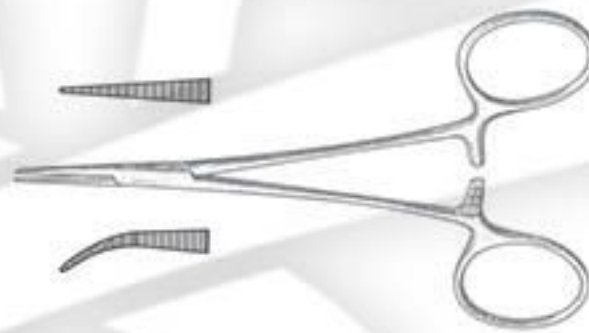

Petit-Point Mosquito Forceps

TI-074-0598 9.8 cm / 3 7/8" - Straight

TI-074-0599 9.8 cm / 3 7/8" - Curved

TI-074-0600 12.0 cm / 4 3/4" - Straight

TI-074-0601 12.0 cm / 4 3/4" - Curved



Petit-Point Mosquito Forceps

TI-074-0602 15.0 cm / 6" - Straight

TI-074-0603 15.0 cm / 6" - Curved

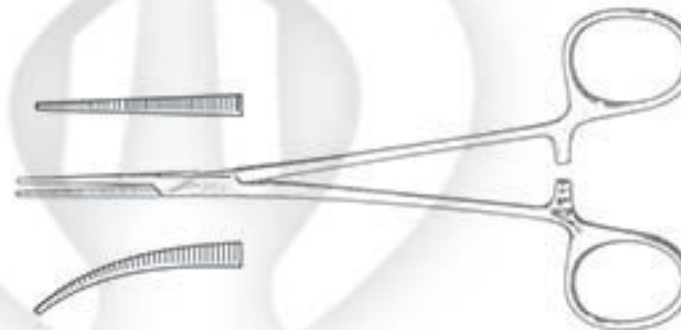

Petit-Point Mosquito Forceps
 TI-075-0604 18.1 cm / 7¹/₈" - Straight
 TI-075-0605 18.1 cm / 7¹/₈" - Curved

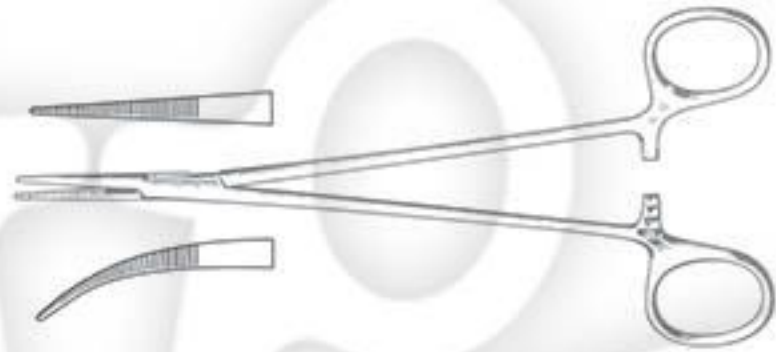

Petit-Point Crile Forceps
 TI-075-0606 14.0 cm / 5¹/₂" - Straight
 TI-075-0607 14.0 cm / 5¹/₂" - Curved

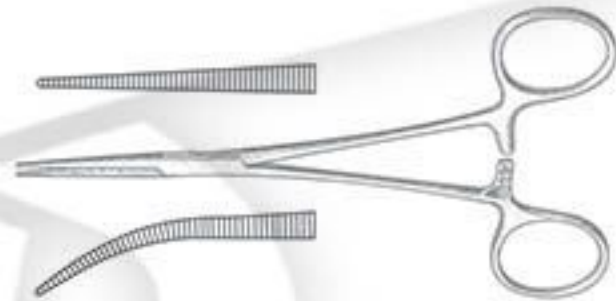

Petit-Point Pean Forceps
 TI-075-0608 14.0 cm / 5¹/₂" - Straight
 TI-075-0609 14.0 cm / 5¹/₂" - Curved

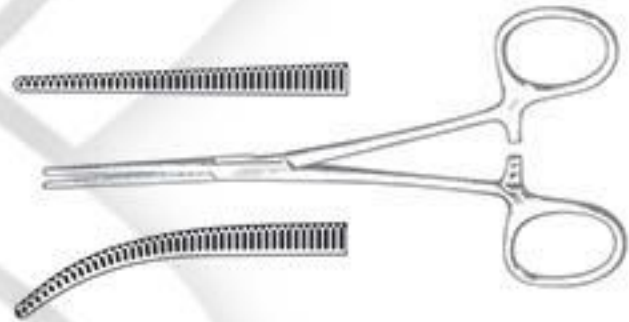

Petit-Point Pean Ochsner Forceps
 TI-075-0610 14.0 cm / 5¹/₂" - Straight
 TI-075-0611 14.0 cm / 5¹/₂" - Curved



TC / GOLD

Petit-Point Reynold Scissors
TI-076-0612 13.0 cm / 5" - Curved
Carb-Edge blades,
one blade serrated

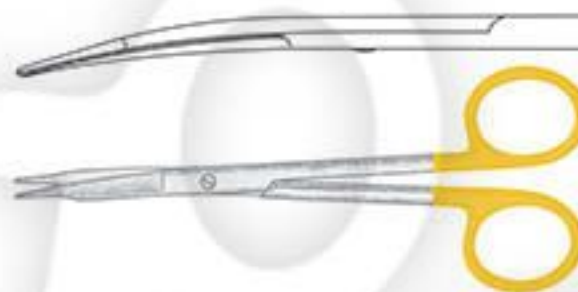

Petit-Point Olsen-Hegar Needle Holders
13.0 cm / 5" - delicate

TI-076-0613 Serrated
TI-076-0614 Smooth

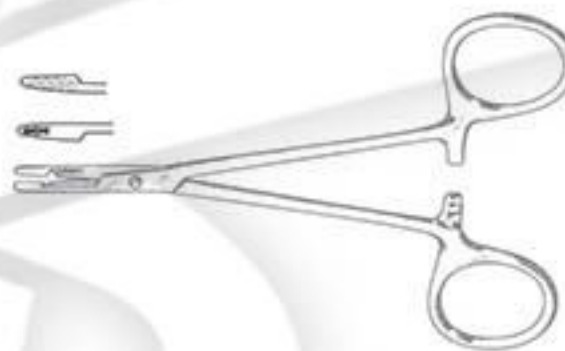

Petit-Point Olsen-Hegar Needle Holders
13.0 cm / 5" - delicate **Carb-Bite** jaws

TI-076-0615 Serrated
TI-076-0616 Smooth



Petit-Point Ryder Needle Holders
1mm **Carb-Bite** jaws, serrated

TI-076-0617 13.0 cm / 5"
TI-076-0618 15.0 cm / 6"
TI-076-0619 18.0 cm / 7"
TI-076-0620 23.0 cm / 9"



TC **GOLD**

Petit-Point Ryder Needle Holders
1mm Carb-Bite jaws, smooth

- TI-077-0621 12.7 cm / 5"
- TI-077-0622 15.0 cm / 6"
- TI-077-0623 18.0 cm / 7"
- TI-077-0624 23.0 cm / 9"



Petit-Point Sarot Needle Holders
1mm Carb-Bite jaws, delicate

- TI-077-0625 15.0 cm / 6"
- TI-077-0626 16.8 cm / 6 3/4"

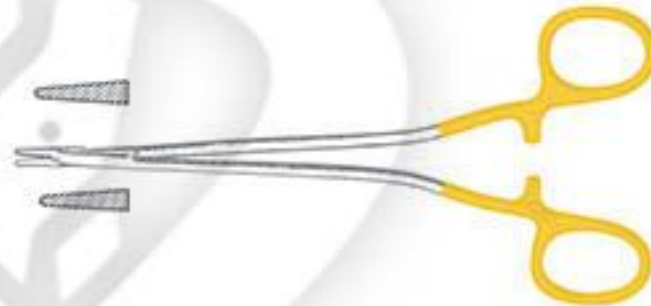

Petit-Point Allis Tissue Forceps
TI-077-0627 13.3 cm / 5 1/4"
3x4 teeth

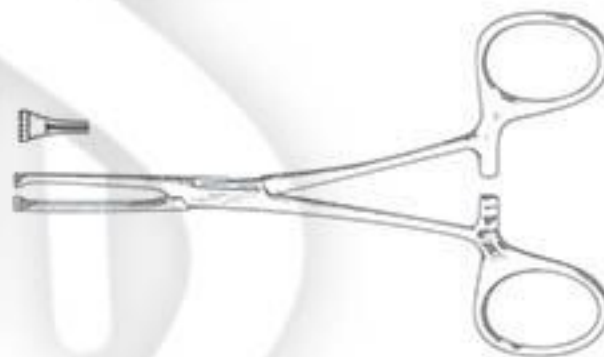

Petit-Point Babcock Forceps

T1-078-0628 13.3 cm / 5¼" jaw width 6 mm

T1-078-0629 16.0 cm / 6¼" jaw width 7.5 mm



Petit-Point Mixer Forceps

T1-078-0630 13.3 cm / 5¼"

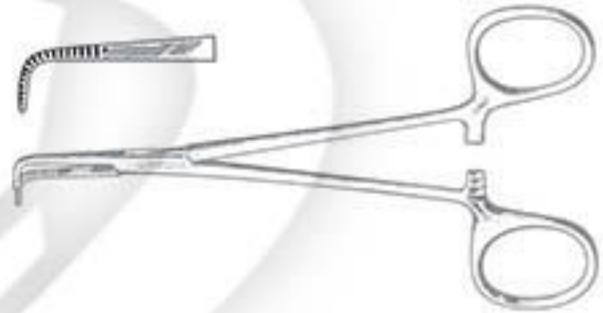

Petit-Point Mixer Forceps

T1-078-0631 18.5 cm / 7¼"

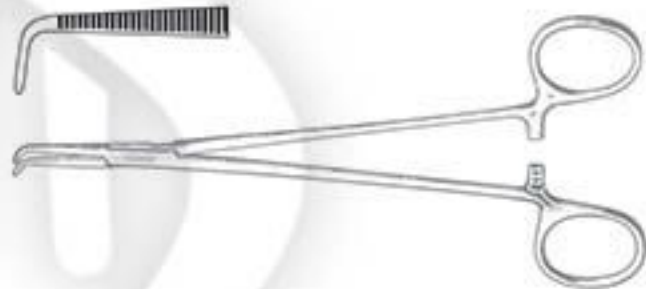



Gross-Maier



TI-079-0632 20.0 cm / 8"
TI-079-0633 25.0 cm / 10"



TI-079-0634 20.0 cm / 8"
TI-079-0635 25.0 cm / 10"

Without ratchet



Gross-Maier



TI-079-0636 20.0 cm / 8"
TI-079-0637 25.0 cm / 10"



TI-079-0638 20.0 cm / 8"
TI-079-0639 25.0 cm / 10"

With ratchet



Gross-Maier



TI-079-0640 20.0 cm / 8"
TI-079-0641 22.0 cm / 8½"
TI-079-0642 25.0 cm / 10"
TI-079-0643 27.0 cm / 10½"



TI-079-0644 20.0 cm / 8"
TI-079-0645 22.0 cm / 8½"
TI-079-0646 25.0 cm / 10"
TI-079-0647 27.0 cm / 10½"



Cheron
TI-080-0648
25.0 cm / 10"

Bozemann
TI-080-0649
26.0 cm / 10 1/4"

Bozemann-Douglas
TI-080-0650
26.0 cm / 10 1/4"

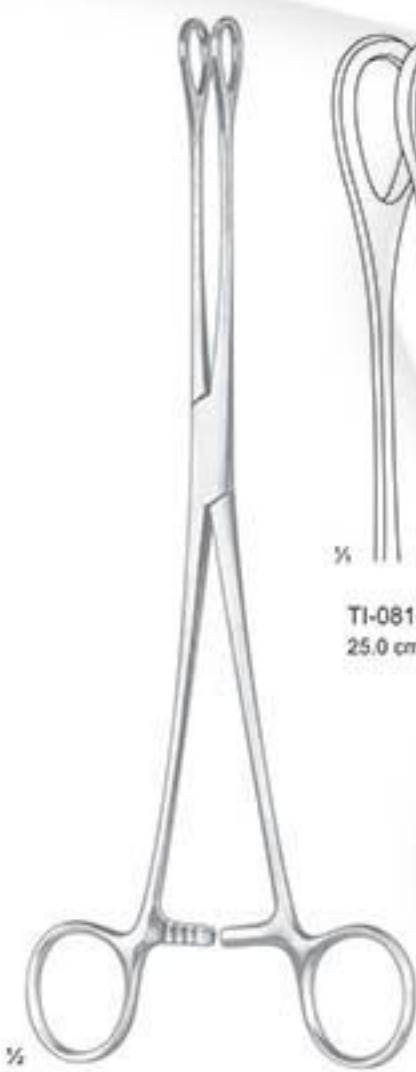

Foerster



TI-081-0651
25.0 cm / 10"



TI-081-0652 18.0 cm / 7"
TI-081-0653 20.0 cm / 8"
TI-081-0654 25.0 cm / 10"



TI-081-0655
25.0 cm / 10"

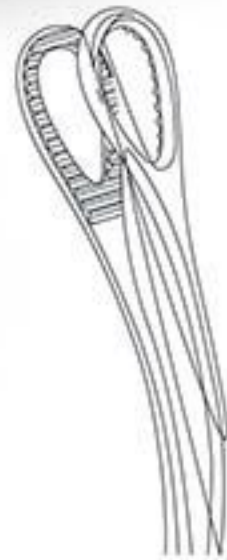

TI-081-0656 18.0 cm / 7"
TI-081-0657 20.0 cm / 8"
TI-081-0658 25.0 cm / 10"

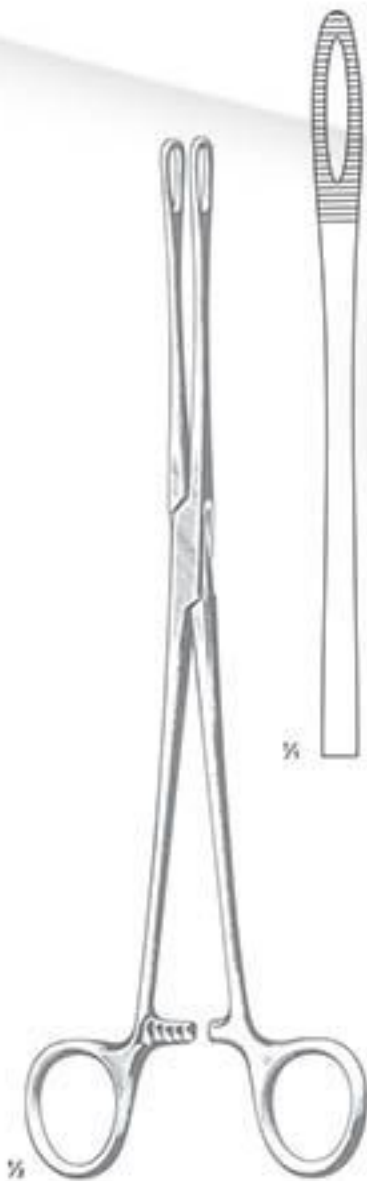

Foerster
 25.0 cm / 10"



TI-082-0659



TI-082-0660



Rampley



TI-082-0661
 25.0 cm / 10"

TC **GOLD**



Standard



TI-083-0662
14.5 cm / 5 7/8"



TI-083-0663
16.5 cm / 6 1/2"



TI-083-0664
18.5 cm / 7 3/8"



Standard



TI-083-0665
14.5 cm / 5 7/8"



TI-083-0666
16.5 cm / 6 1/2"

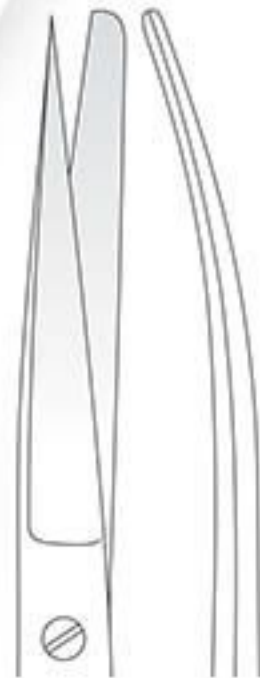

TI-083-0667
18.5 cm / 7 3/8"

TC GOLD



Standard



TI-084-0668
14.5 cm / 5 7/8"



TI-084-0669
16.5 cm / 6 1/2"



TI-084-0670
18.5 cm / 7 1/4"



Standard



TI-084-0671
14.5 cm / 5 7/8"



TI-084-0672
16.5 cm / 6 1/2"



TI-084-0673
18.5 cm / 7 1/4"

TC **GOLD**



Mayo



TI-085-0674
14.5 cm / 5 3/4"



TI-085-0675
17.0 cm / 6 3/4"



TI-085-0676
23.0 cm / 9"



Mayo



TI-085-0677
14.5 cm / 5 3/4"



TI-085-0678
17.0 cm / 6 3/4"



TI-085-0679
23.0 cm / 9"

TC / GOLD



TI-086-0680
14.0 cm / 5½"



TI-086-0681
17.0 cm / 7"



TI-086-0682
23.0 cm / 9"

TC / GOLD



1/2 Mayo-Stille



TI-087-0683
15.0 cm / 6"



TI-087-0684
17.0 cm / 7"



1/2 Mayo-Stille



TI-087-0685
15.0 cm / 6"



TI-087-0686
17.0 cm / 7"

TC / GOLD



TC / GOLD



TI-089-0691
18.0 cm / 7"



TI-089-0692
20.0 cm / 8"



TI-089-0693
23.0 cm / 9"



Metzenbaum



TI-089-0694
25.0 cm / 10"



TI-089-0695
28.0 cm / 11"

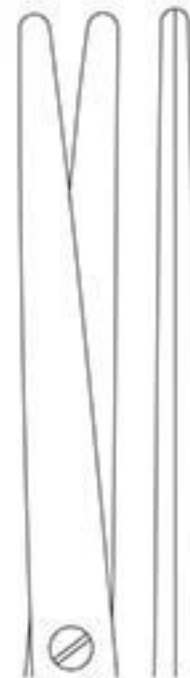

TI-089-0696
30.0 cm / 12"

TC / GOLD



T1-090-0697
18.0 cm / 7"



T1-090-0698
20.0 cm / 8"



T1-090-0699
23.0 cm / 9"



Metzenbaum



T1-090-0700
25.0 cm / 10"



T1-090-0701
28.0 cm / 11"

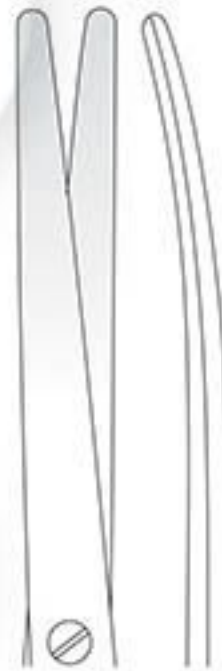

T1-090-0702
30.0 cm / 12"

TC **GOLD**



TC / GOLD



Mayo-Harrington



TI-092-0707
28.0 cm / 11"



Sims



TI-092-0708
23.0 cm / 9"

TC **GOLD**

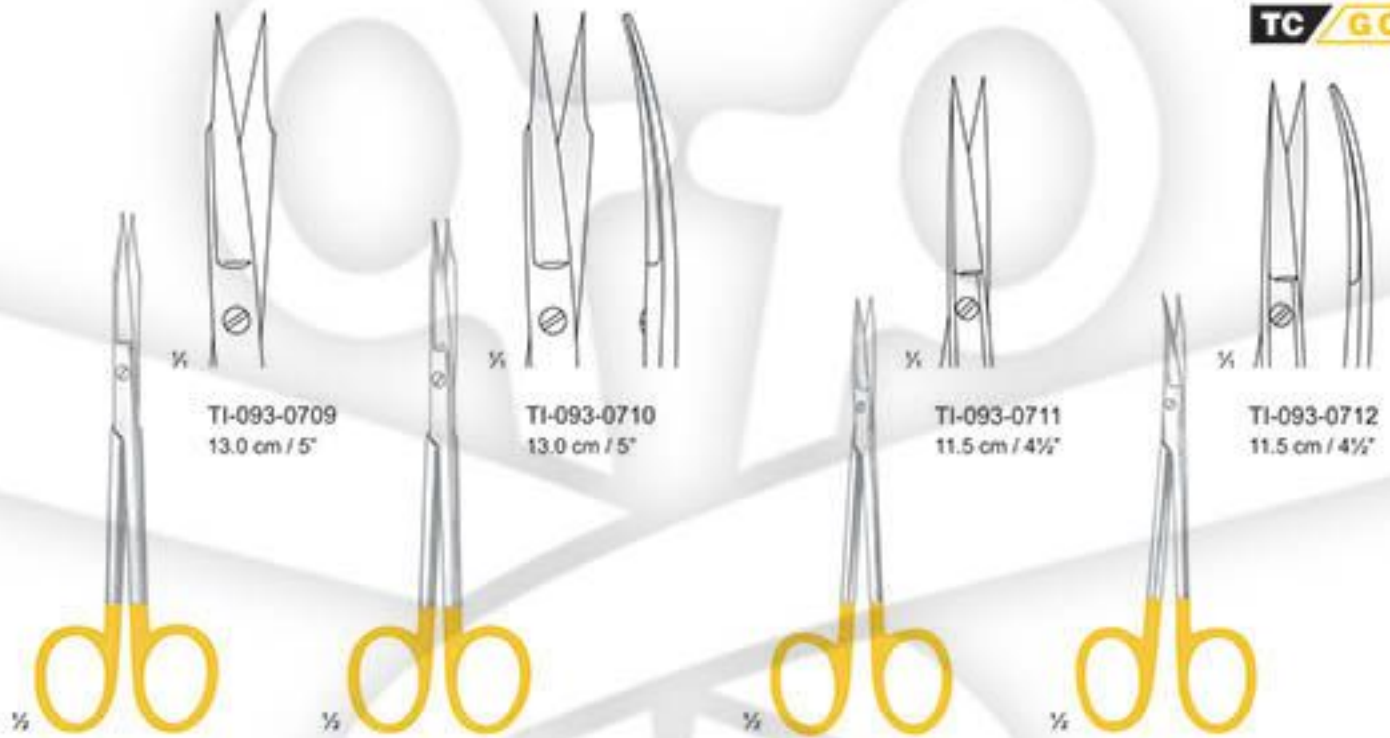

TC / GOLD

Mayo Scissors

- TI-094-0719 14.0 cm / 5½" Straight
- TI-094-0720 14.0 cm / 5½" Curved
- TI-094-0721 17.0 cm / 6¾" Straight
- TI-094-0722 17.0 cm / 6¾" Curved

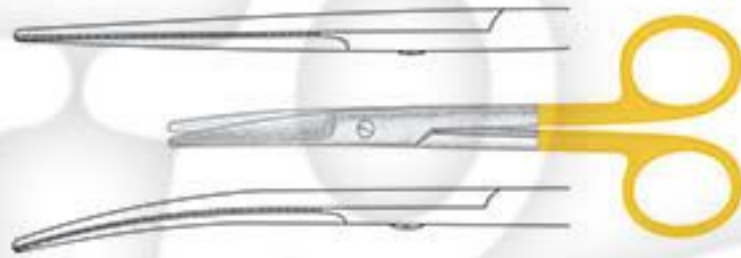

Mayo Scissors

- TI-094-0723 23.0 cm / 9" Straight
- TI-094-0724 23.0 cm / 9" Curved

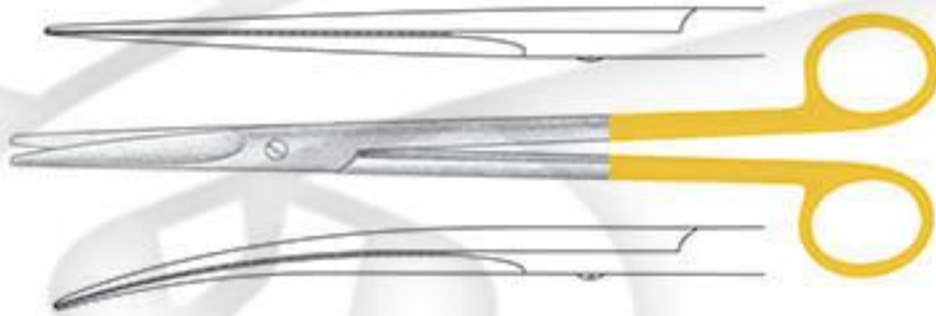

Metzenbaum (Lehey)

- TI-094-0725 14.6 cm / 5¾" Straight
- TI-094-0726 14.6 cm / 5¾" Curved

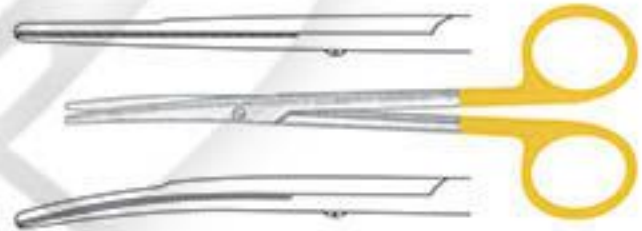

Metzenbaum

- TI-094-0727 18.0 cm / 7" Straight
- TI-094-0728 23.0 cm / 9" Curved



Iris Scissors

- TI-094-0729 11.5 cm / 4½" Straight
- TI-094-0730 11.5 cm / 4½" Curved



TC / GOLD

Knight Nasal Scissors
TI-095-0731 17.0 cm / 6 3/4"



Plastic Surgery Scissors
TI-095-0732 12.0 cm / 4 3/4", Straight
TI-095-0733 12.0 cm / 4 3/4", Curved



Castanares Face Lift Scissors
TI-095-0734 - 16.0 cm / 6 1/4", Straight

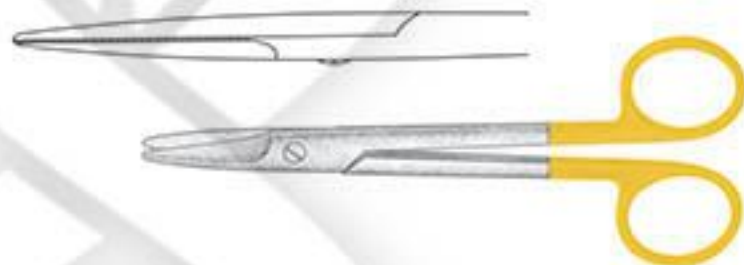

Gorney
TI-095-0735 18.5 cm / 7 1/4", Straight
TI-095-0736 18.5 cm / 7 1/4", Curved

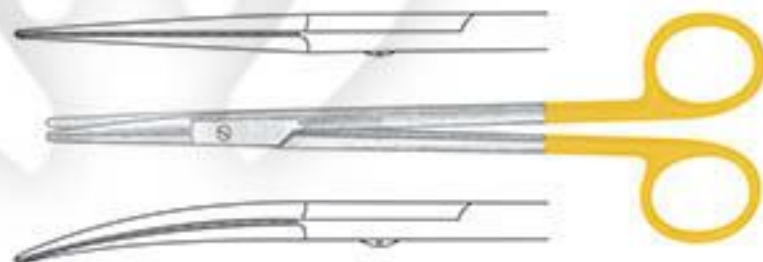

TC / GOLD

Kaye Face Lift Scissors

beveled blades have semi-sharp outer edges

TI-096-0737 15.0 cm / 6", Curved

TI-096-0738 19.0 cm / 7½", Curved

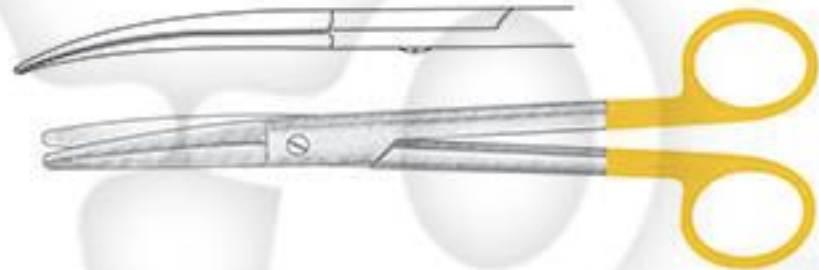

Freeman-Gorney Face Lift Scissors

beveled blades have semi-sharp outer edges and flat, tapered tips;

TI-096-0739 19.0 cm / 7½", Straight

TI-096-0740 19.0 cm / 7½", Curved

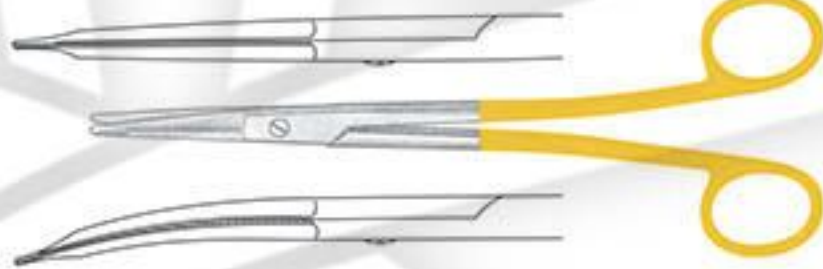

Freeman-Kaye Face Lift Scissors

beveled blades have semi-sharp outer edges and flat, tapered tips;

TI-096-0741 - 18.0 cm / 7", Straight

TI-096-0742 - 18.0 cm / 7", Curved

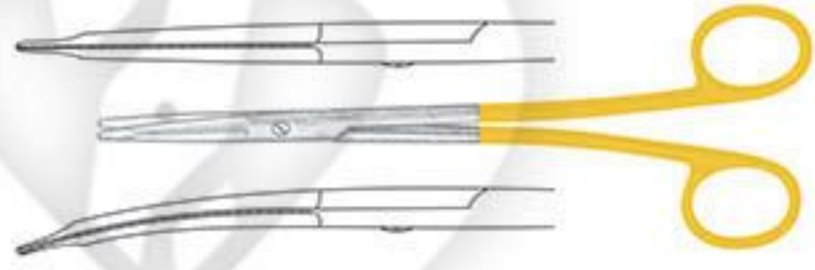

Freeman Rhytidectomy Scissors

TI-096-0743 - 18.0 cm / 7", Curved with flat tips



Gorney Platysma Scissors

beveled blades have semi-sharp outer edges and flat, tapered tips;

TI-096-0744 - 23.0 cm / 9", Straight

TI-096-0745 - 23.0 cm / 9", Curved

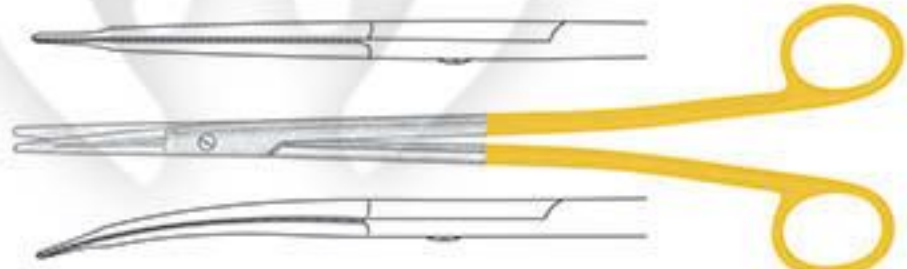

TC **GOLD**

Fomon Lateral Scissors
TI-097-0746
13.0 cm / 5", full curved

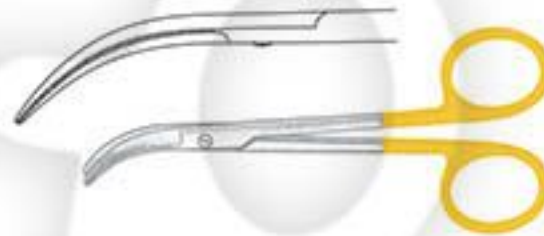

Fomon Dorsal Scissors
TI-097-0747 - 14.6 cm / 5 7/8", angled on flat

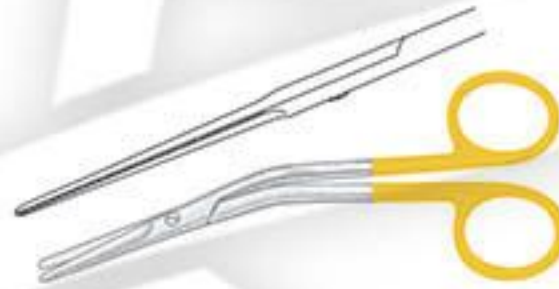

Cottle Dorsal Scissors
TI-097-0748 16.5 cm / 6 1/2", angled on flat



Plastic and Reconstructive Scissors
TI-097-0749 11.4 cm / 4 1/2", curved
TI-097-0750 14.6 cm / 5 7/8", curved



Petit-Point Reconstructive Scissors
TI-097-0751 13.0 cm / 5", curved

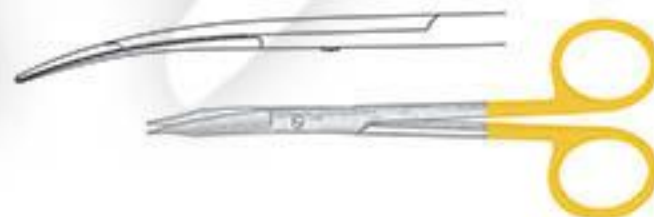

TC / GOLD

Jamison Scissors

TI-098-0752 14.0 cm / 5½", curved

TI-098-0753 18.0 cm / 7", curved

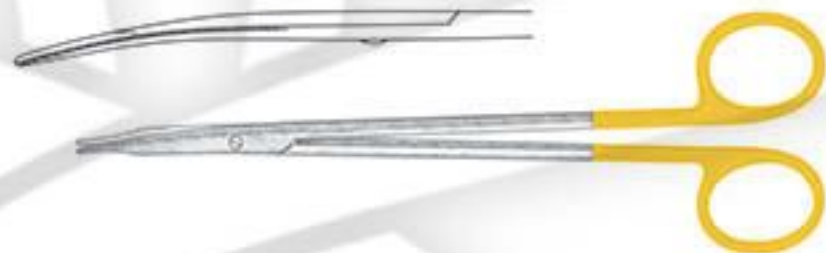

Metzenbaum Scissors

TI-098-0754 18.0 cm / 7" curved, delicate



Endarterectomy Scissors

TI-098-0755 17.0 cm / 6¾" curved, delicate



TC / GOLD



Potts-Smith Scissors

- TI-099-0756 18.0 cm / 7" 25°
- TI-099-0757 18.0 cm / 7" 45°
- TI-099-0758 18.0 cm / 7" 60°



Diethrich Coronary Artery Scissors

- TI-099-0759 18.0 cm / 7" 25°
- TI-099-0760 18.0 cm / 7" 45°
- TI-099-0761 18.0 cm / 7" 60°
- TI-099-0762 18.0 cm / 7" 90°
- TI-099-0763 18.0 cm / 7" 125°

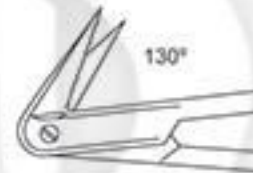

Diethrich Coronary Artery Scissors

- TI-099-0764 - 18.0 cm / 7" 130°

shanks are stabilized
to keep blades in alignment

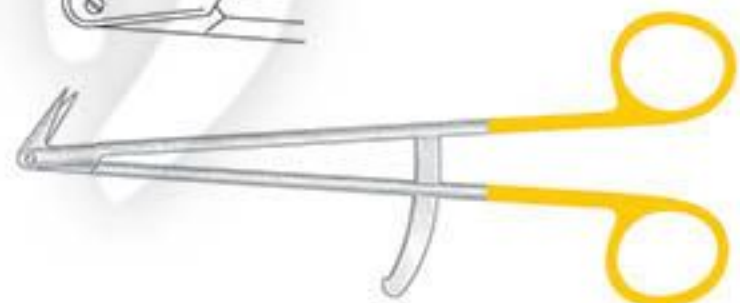

TC **GOLD**

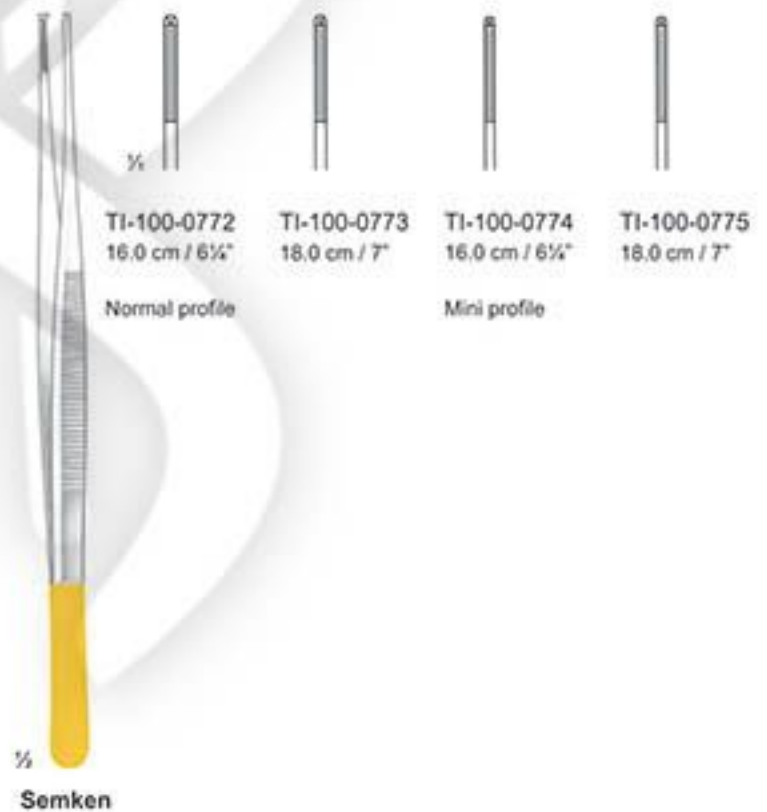
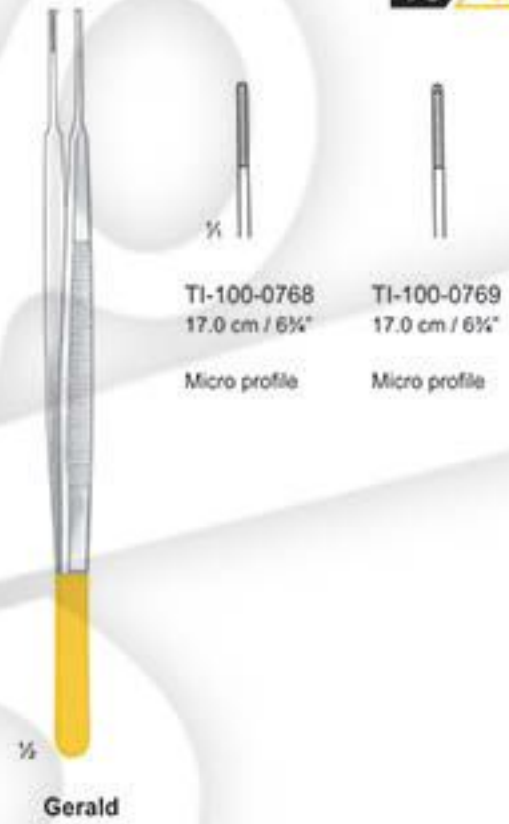
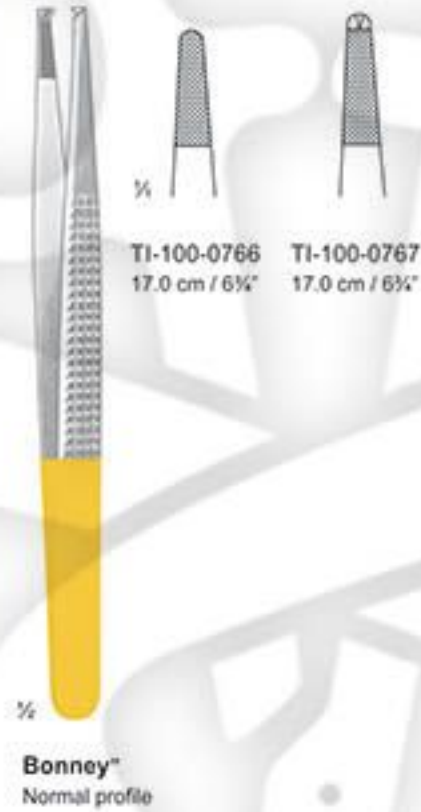

TC **GOLD**



TI-101-0776
12.0 cm / 4 1/2"
Normal profile

Adson-Brown



TI-101-0777
12.0 cm / 4 1/2"

Micro-Adson
Mini profile



TI-101-0778
15.0 cm / 6"

Adson
Normal profile



TI-101-0779
12.0 cm / 4 1/2"

TI-101-0781
15.0 cm / 6"



TI-101-0780
12.0 cm / 4 1/2"

TI-101-0782
15.0 cm / 6"



TI-101-0783
17.0 cm / 7"

Cushing
Normal profile

with dissector end



TI-101-0784
18.0 cm / 7"

Cushing
Normal profile

with dissector end



TI-101-0785
18.0 cm / 7"

Cushing-Taylor
Normal profile

TC **GOLD**



Potts-Smith



TI-102-0786
15.0 cm / 6"



TI-102-0787
18.0 cm / 7"



TI-102-0788
20.0 cm / 8"



TI-102-0789
23.0 cm / 9"



TI-102-0790
25.0 cm / 10"

Normal profile



Oehler



TI-102-0791
14.0 cm / 5½"



TI-102-0792
16.0 cm / 6½"



TI-102-0793
18.0 cm / 7"



TI-102-0794
20.0 cm / 8"



TI-102-0795
25.0 cm / 10"



TI-102-0796
30.0 cm / 12"

Normal profile

TC **GOLD**

Micro profile

Mini profile



De Bakay



TI-103-0797
15.0 cm / 6"



TI-103-0798
19.0 cm / 7½"



TI-103-0799
24.0 cm / 9½"



TI-103-0800
15.0 cm / 6"



TI-103-0801
19.0 cm / 7½"



TI-103-0802
24.0 cm / 9½"



TI-103-0803
15.0 cm / 6"

Smooth



Wangenstein
Normal Profile



TI-103-0804
15.0 cm / 6"



TI-103-0805
23.0 cm / 9"



TI-103-0806
25.0 cm / 10"



Graefe
16.0 cm / 6¼"



TI-104-0807
sharp



TI-104-0808
blunt



Graefe
16.0 cm / 6¼"



TI-104-0809



TI-104-0810



TI-104-0811



TI-104-0812



O'Connor



TI-104-0813
16.0 cm / 6¼"



Guthrie



TI-104-0814
16.0 cm / 6¼"

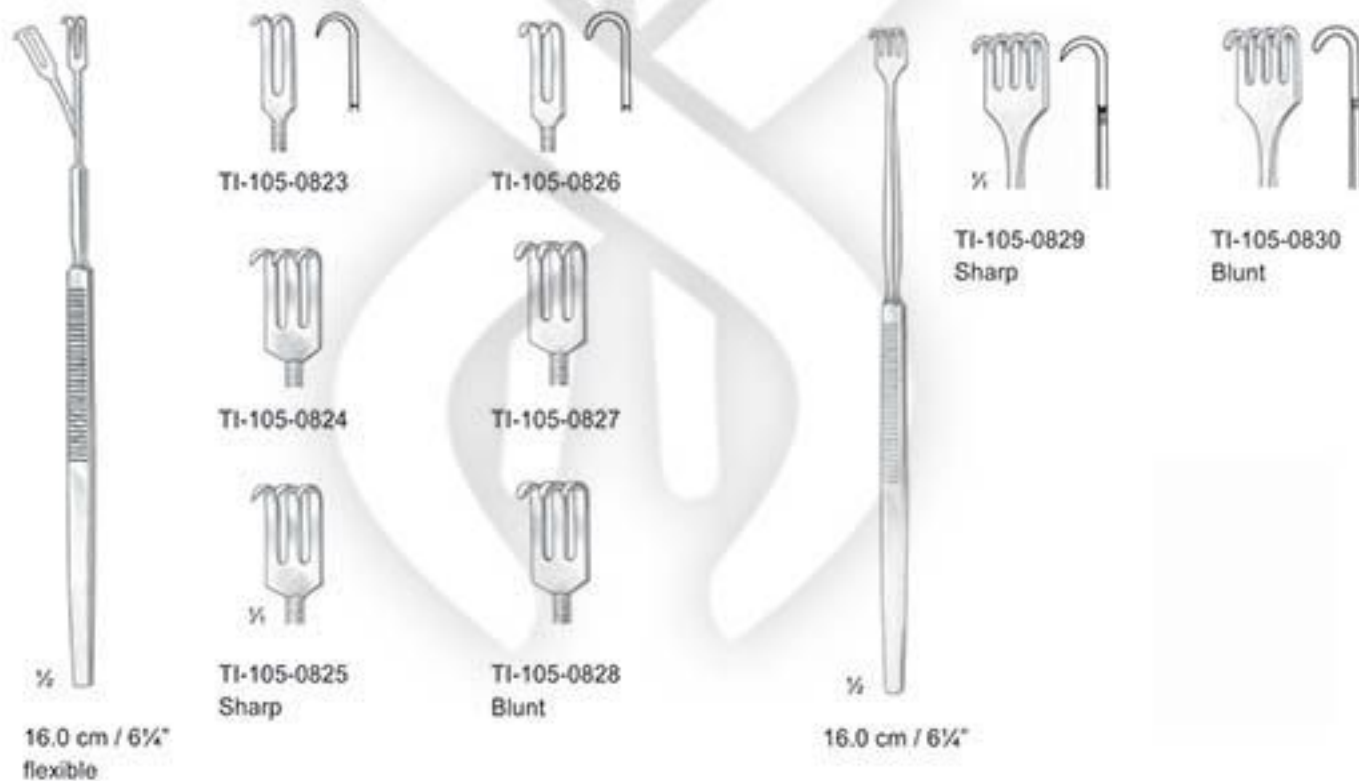
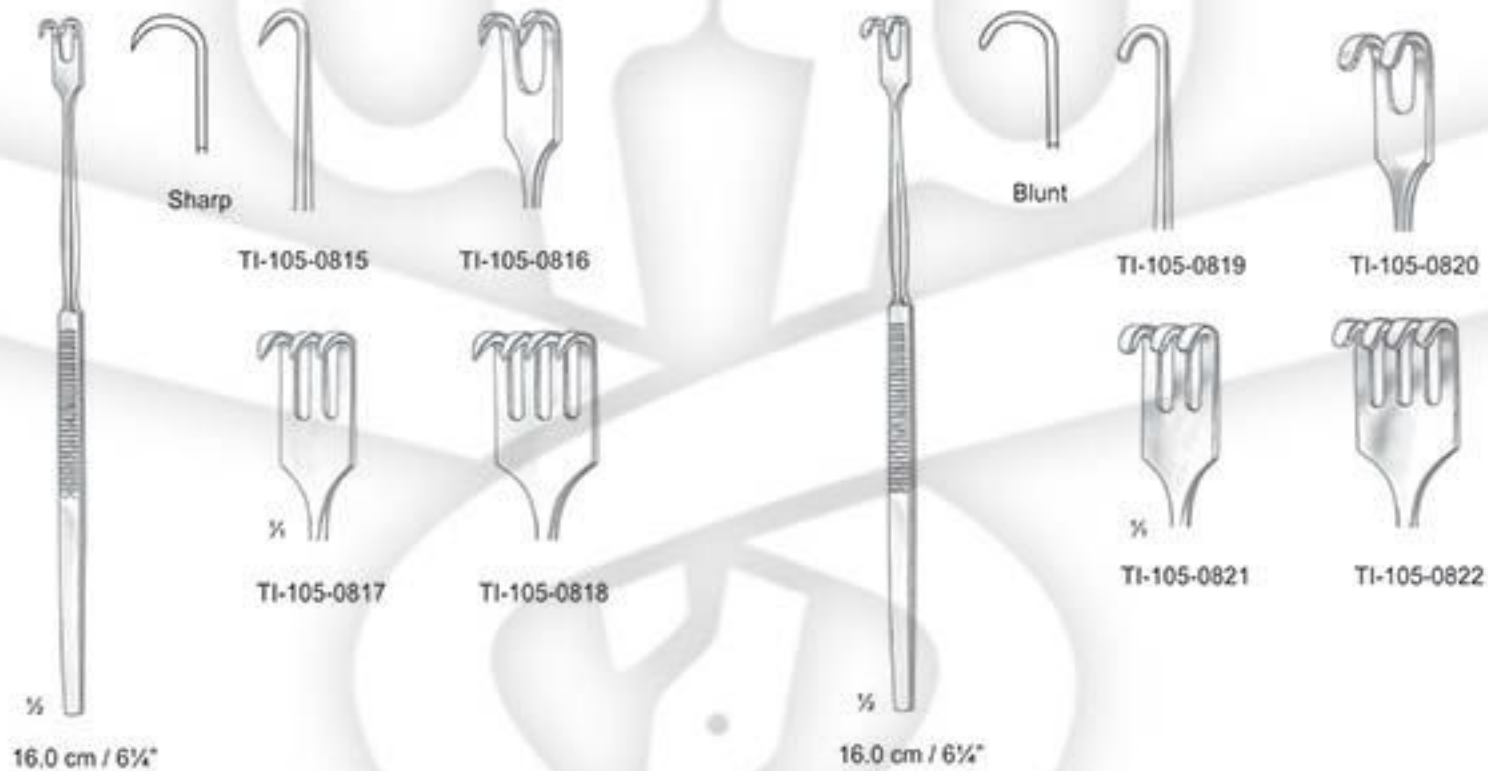

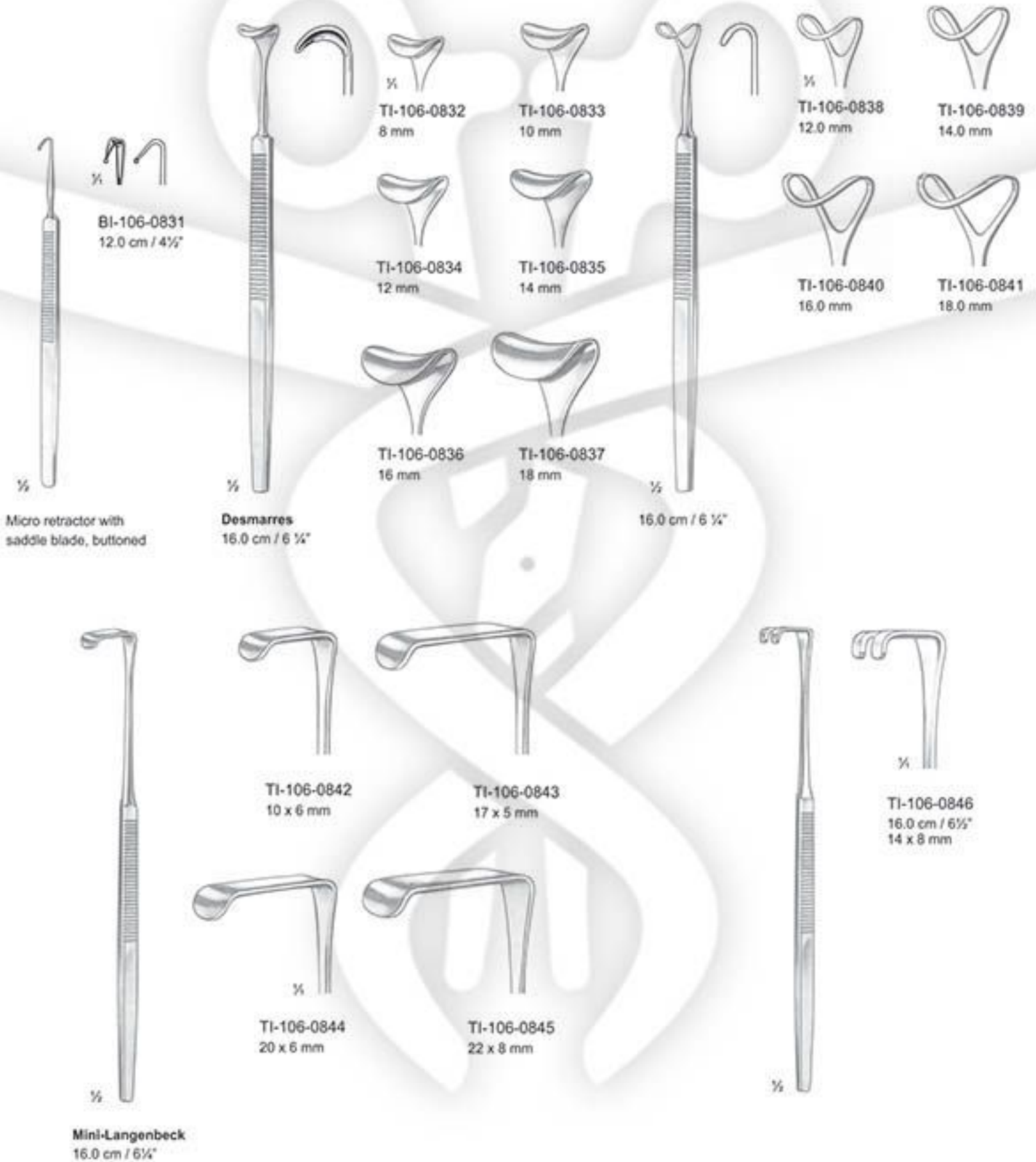

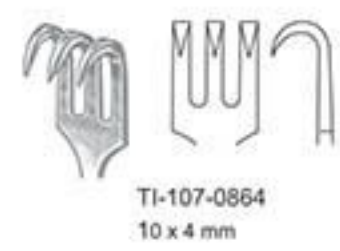

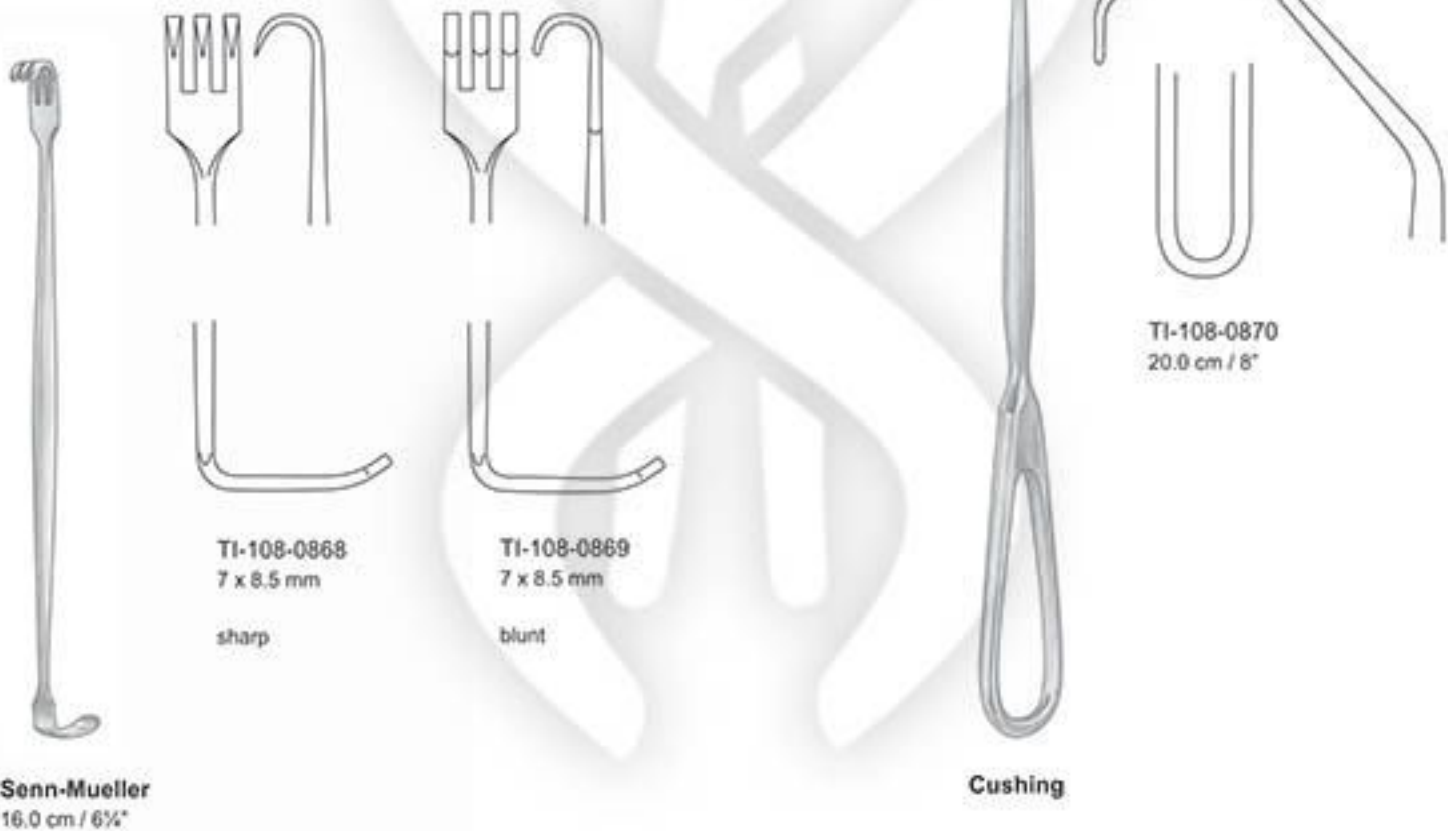
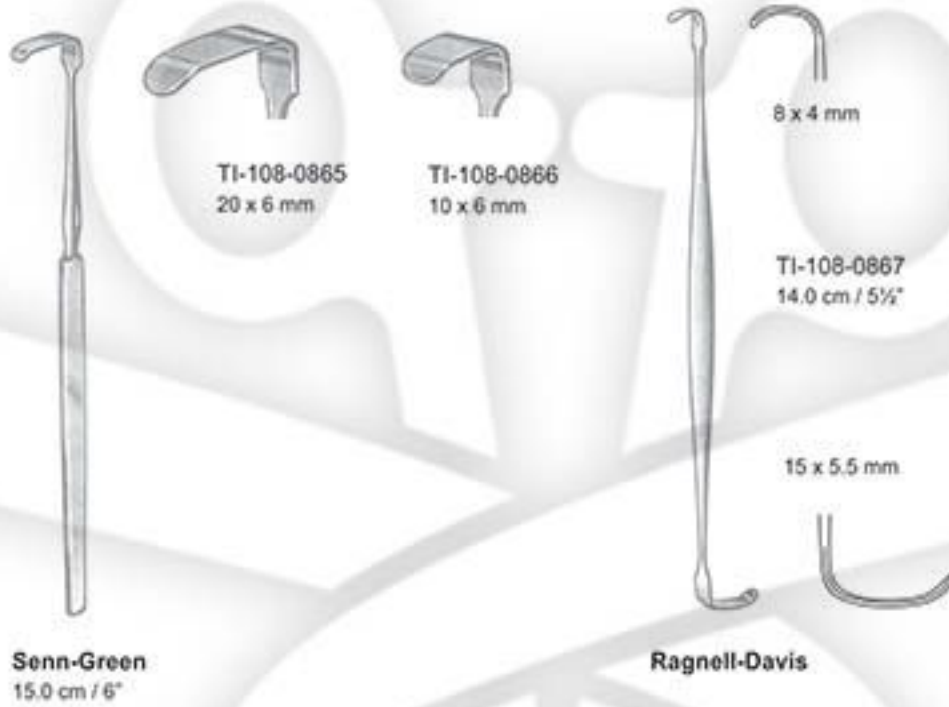

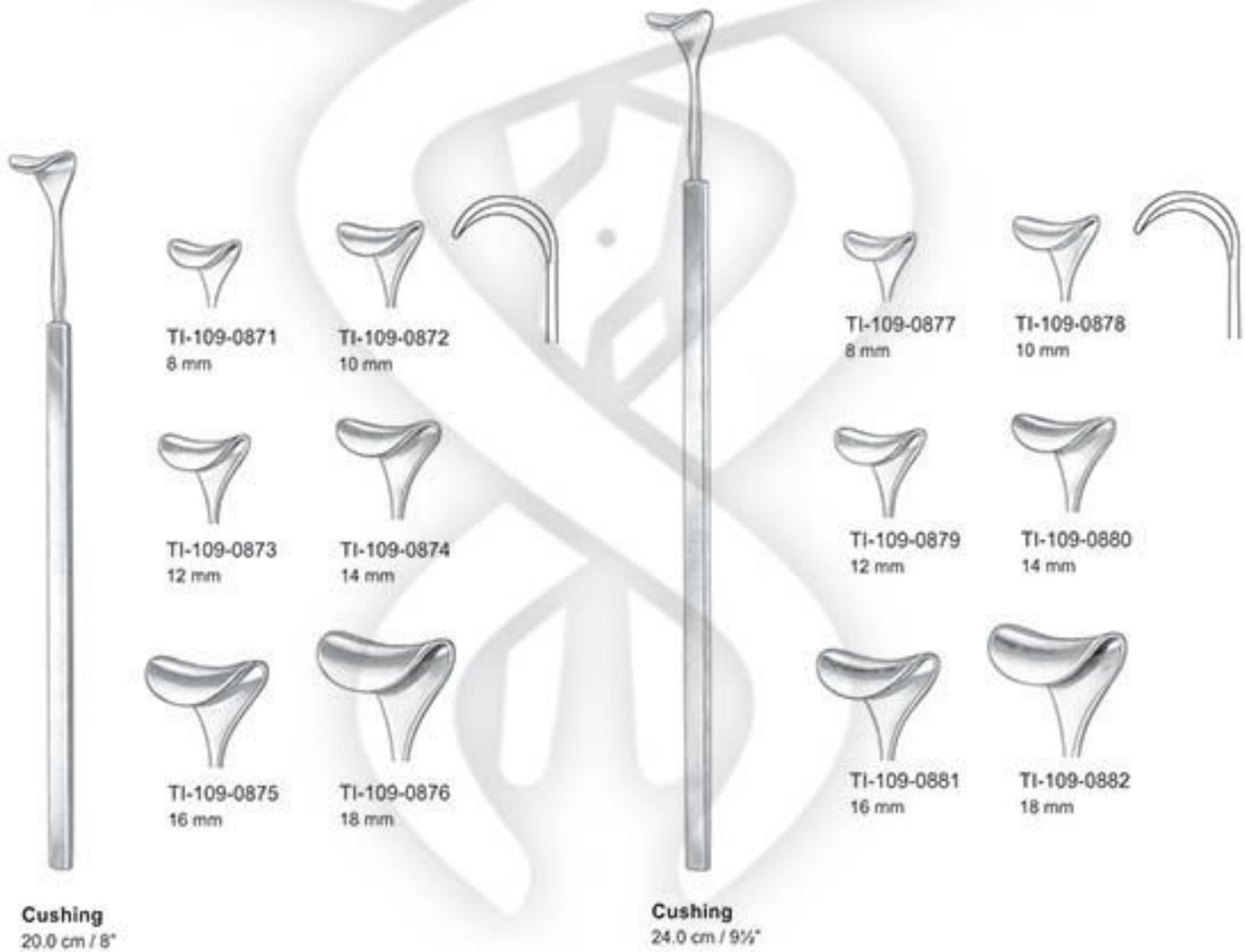

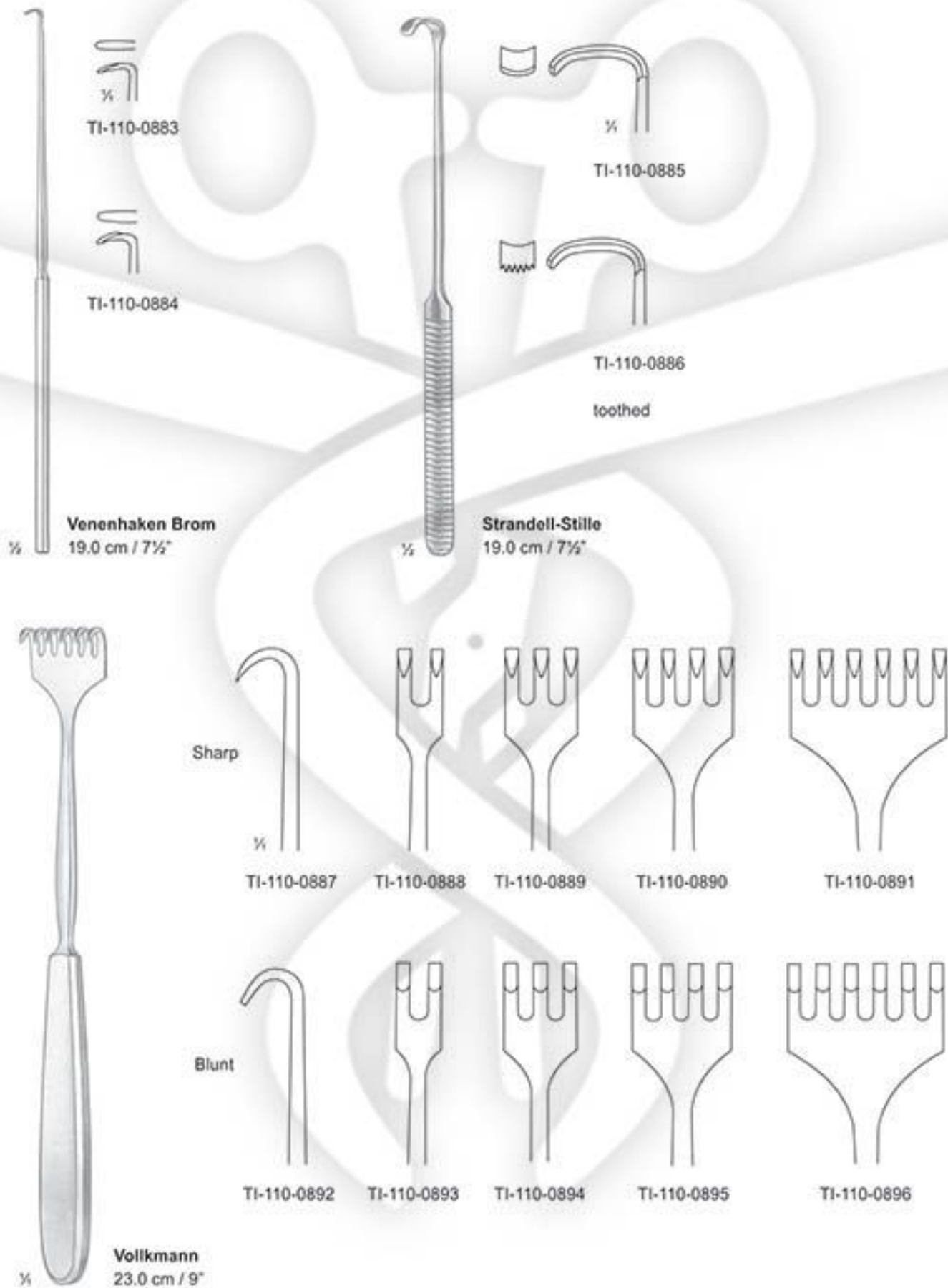





1/2
Kocher
22.0 cm / 8 3/4"



Special Model
22.0 cm / 8 3/4"



1/2
TI-113-0933



TI-113-0934



TI-113-0935



TI-113-0936



Sharp 1/2



1/2
TI-113-0937



TI-113-0938



TI-113-0939



TI-113-0940

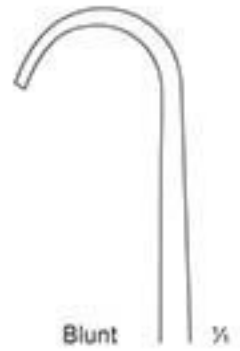

Blunt 1/2

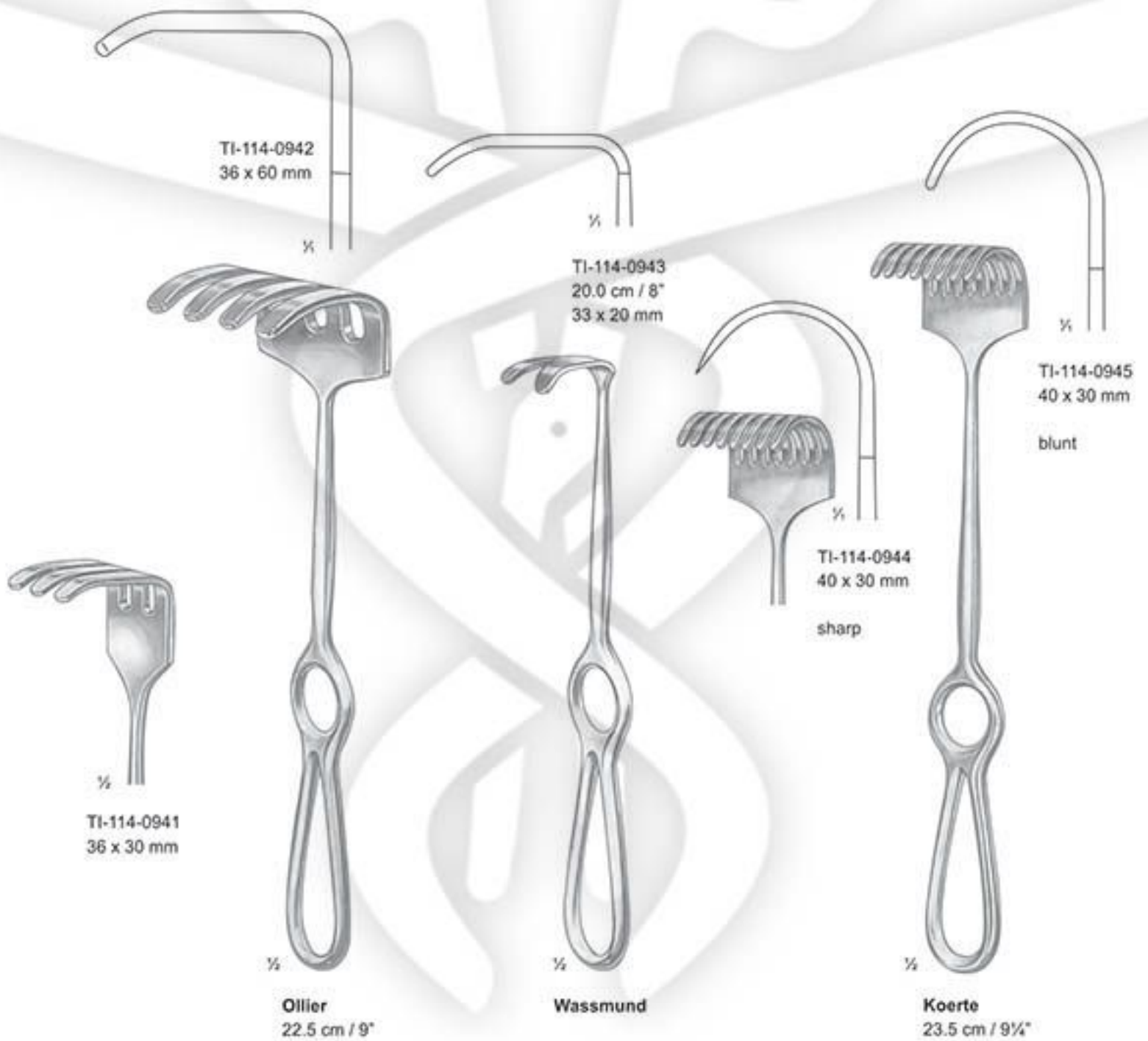



TI-115-0946
40 x 40 mm



TI-115-0947
45 x 50 mm



TI-115-0948
50 x 60 mm

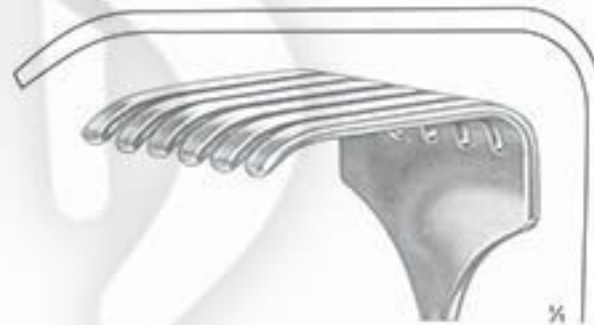

TI-115-0949
70 x 70 mm



Israel
25.0 cm / 10"



¼
Langenbeck
22.0 cm / 8½"



¼
Langenbeck
20.0 cm / 8¼"



TI-116-0950
TI-116-0951
30 x 11 mm

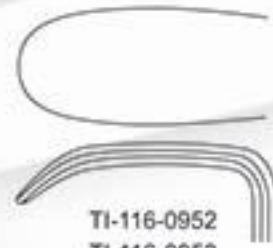

TI-116-0952
TI-116-0953
30 x 14 mm



TI-116-0954
TI-116-0955
30 x 16 mm



TI-116-0956
TI-116-0957
40 x 11 mm



TI-116-0958
TI-116-0959
50 x 11 mm

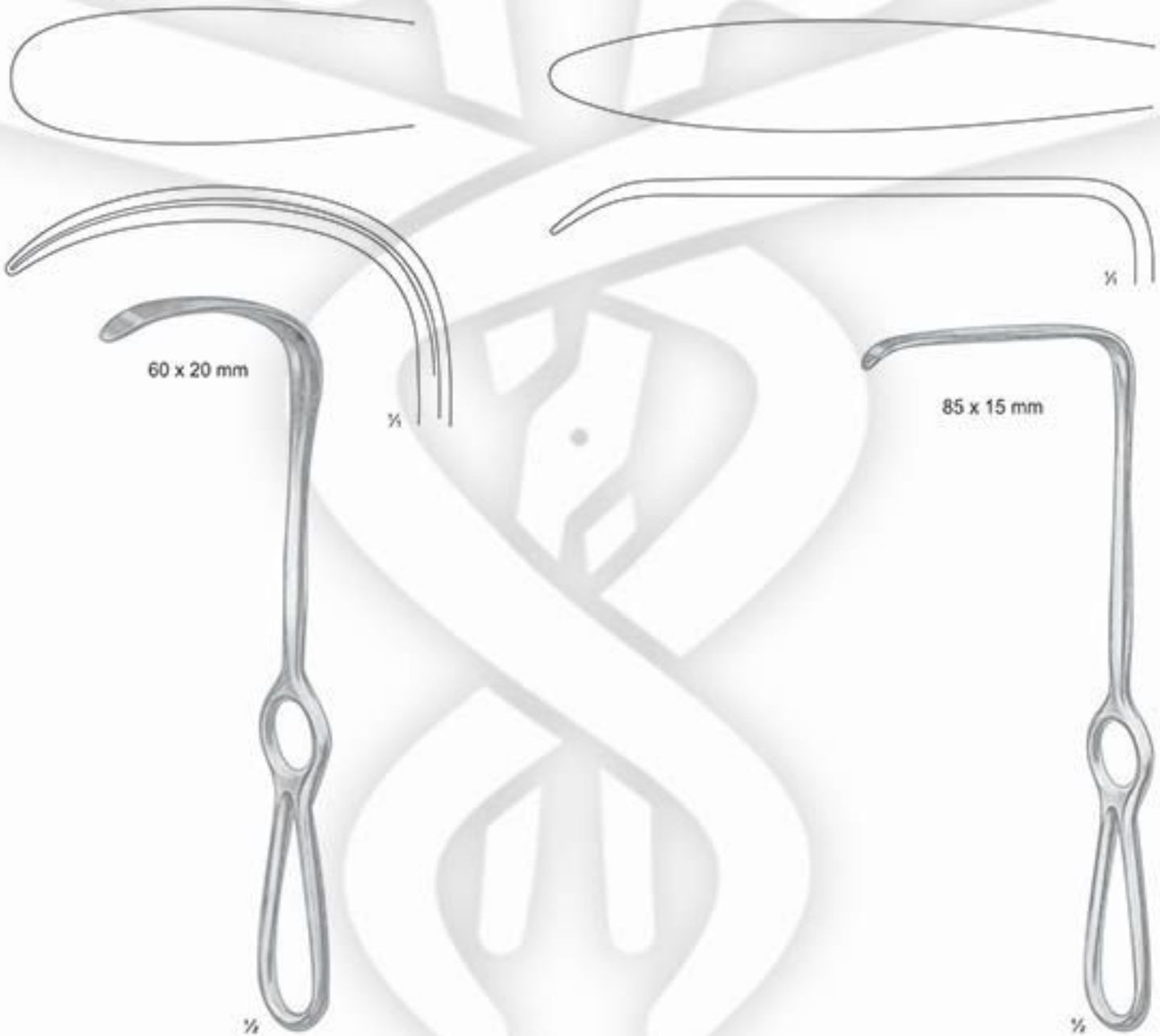

Langenbeck
TI-117-0960
21.0 cm / 8 1/4"

Langenbeck
TI-117-0961
21.0 cm / 8 1/2"



½

Kocher
23.0 / 9"



TI-118-0962
40 x 18 mm



TI-118-0963
60 x 20 mm



TI-118-0964
60 x 25 mm



TI-118-0965
75 x 30 mm



TI-118-0966
75 x 40 mm

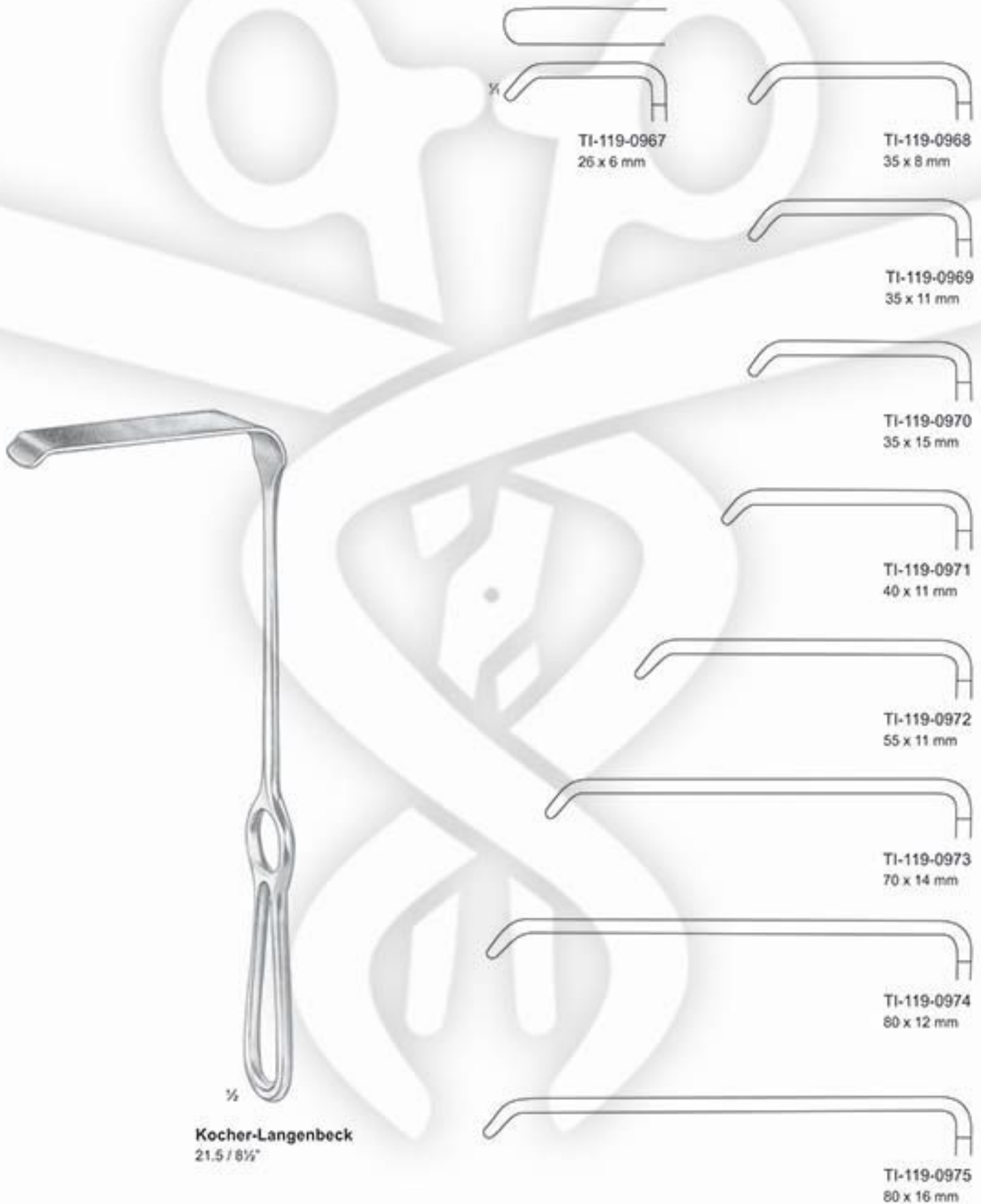

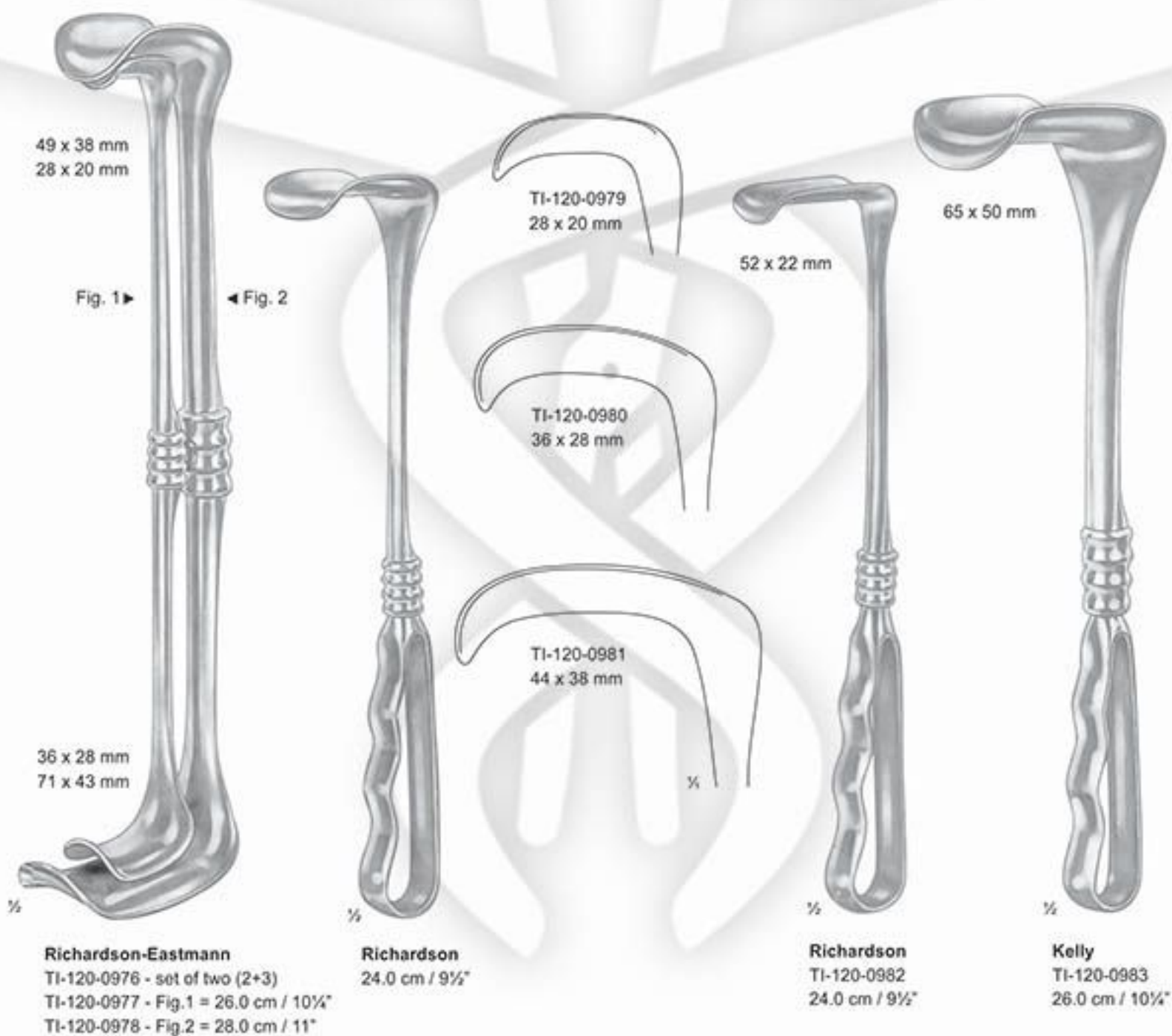

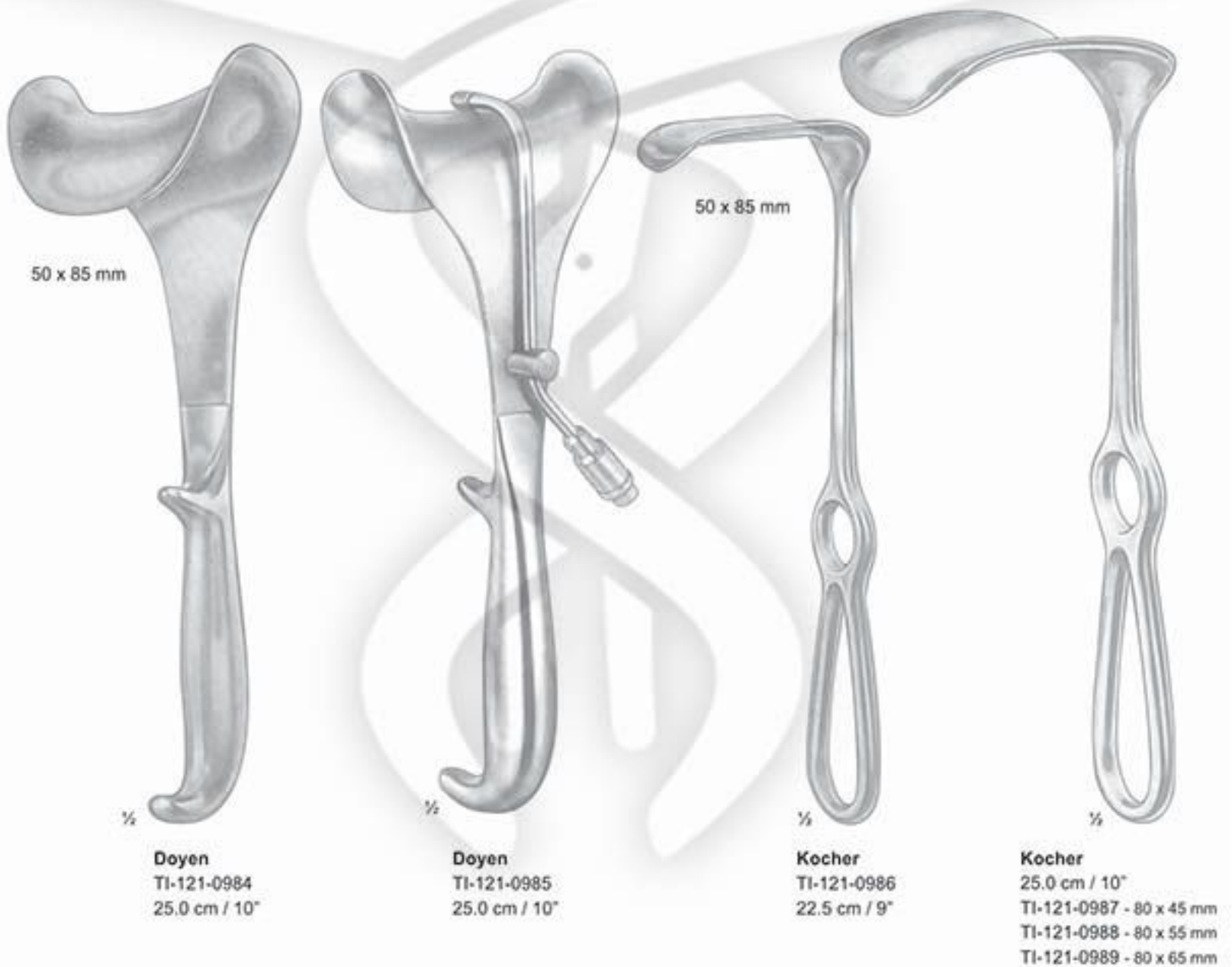

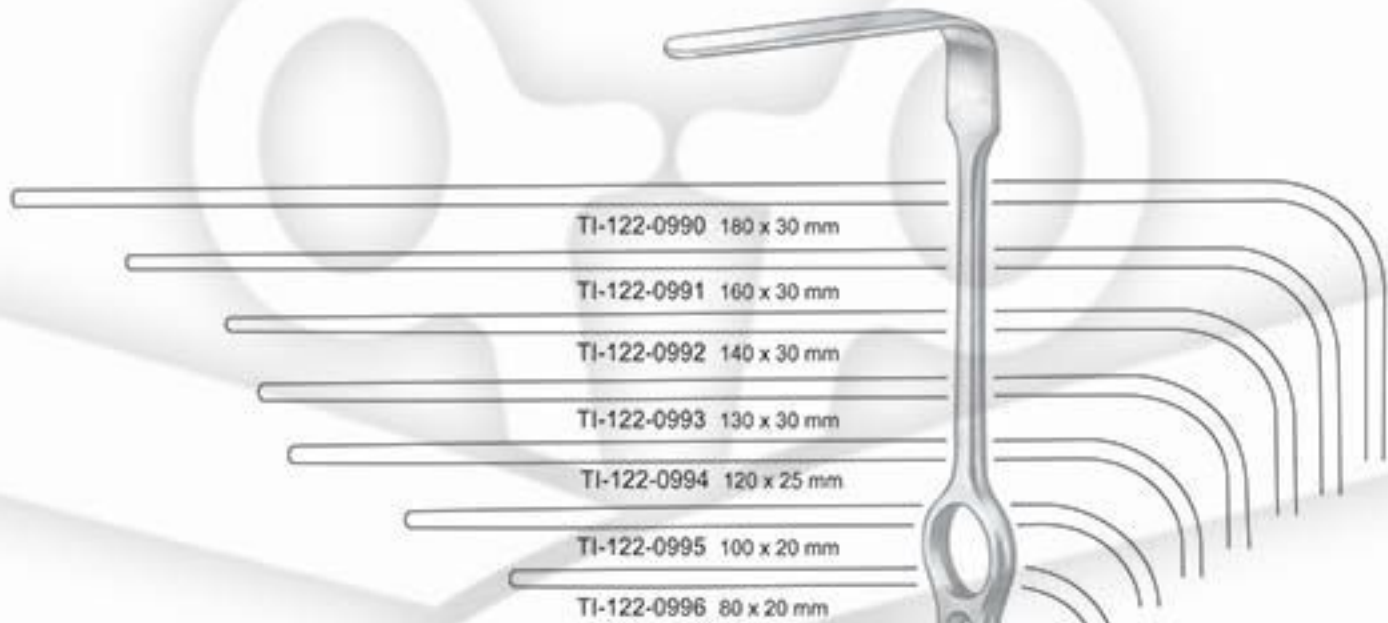

Brunner
25.0 cm / 10"

⅓



Brunner
25.0 cm / 10"

⅓

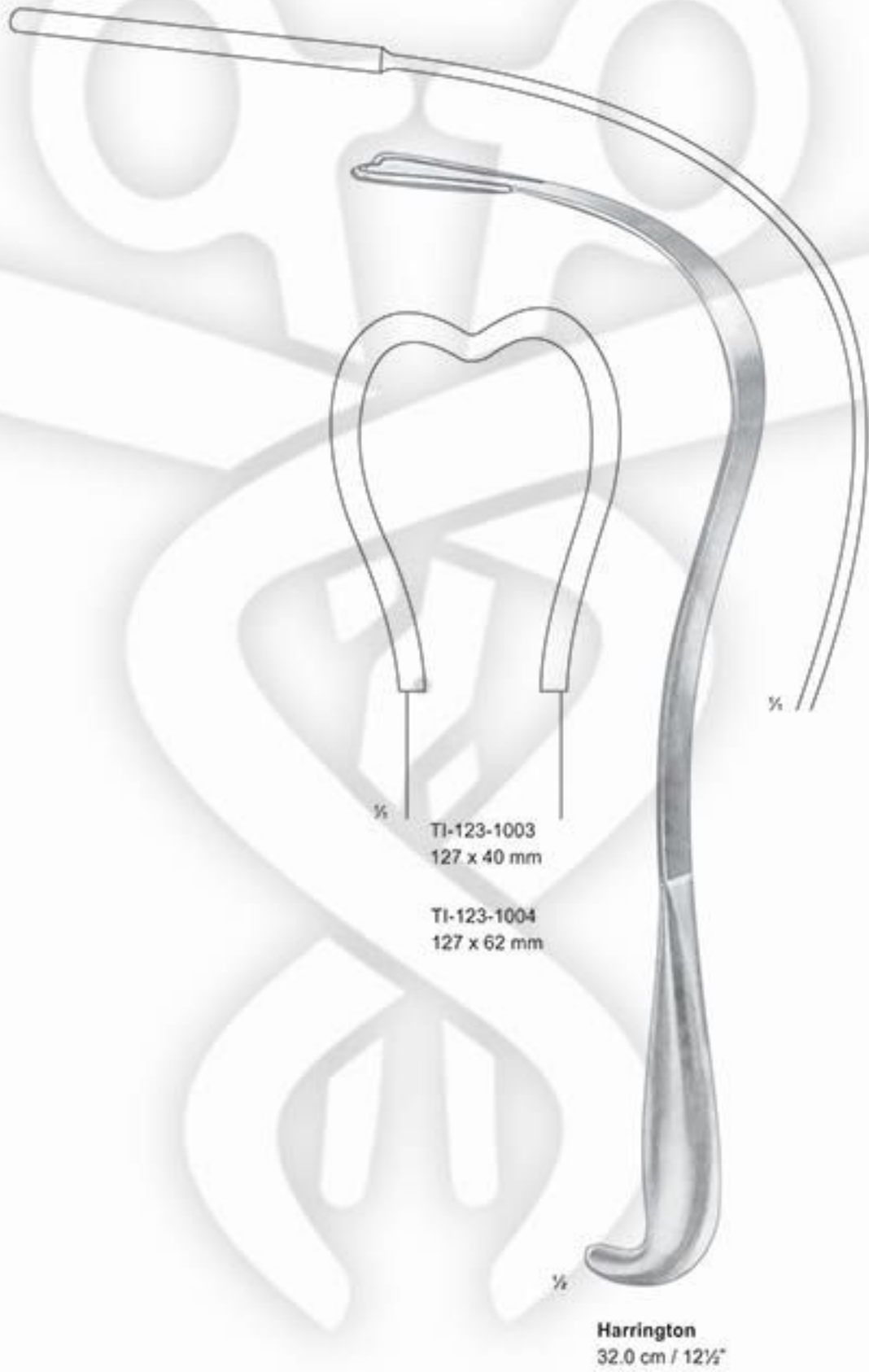

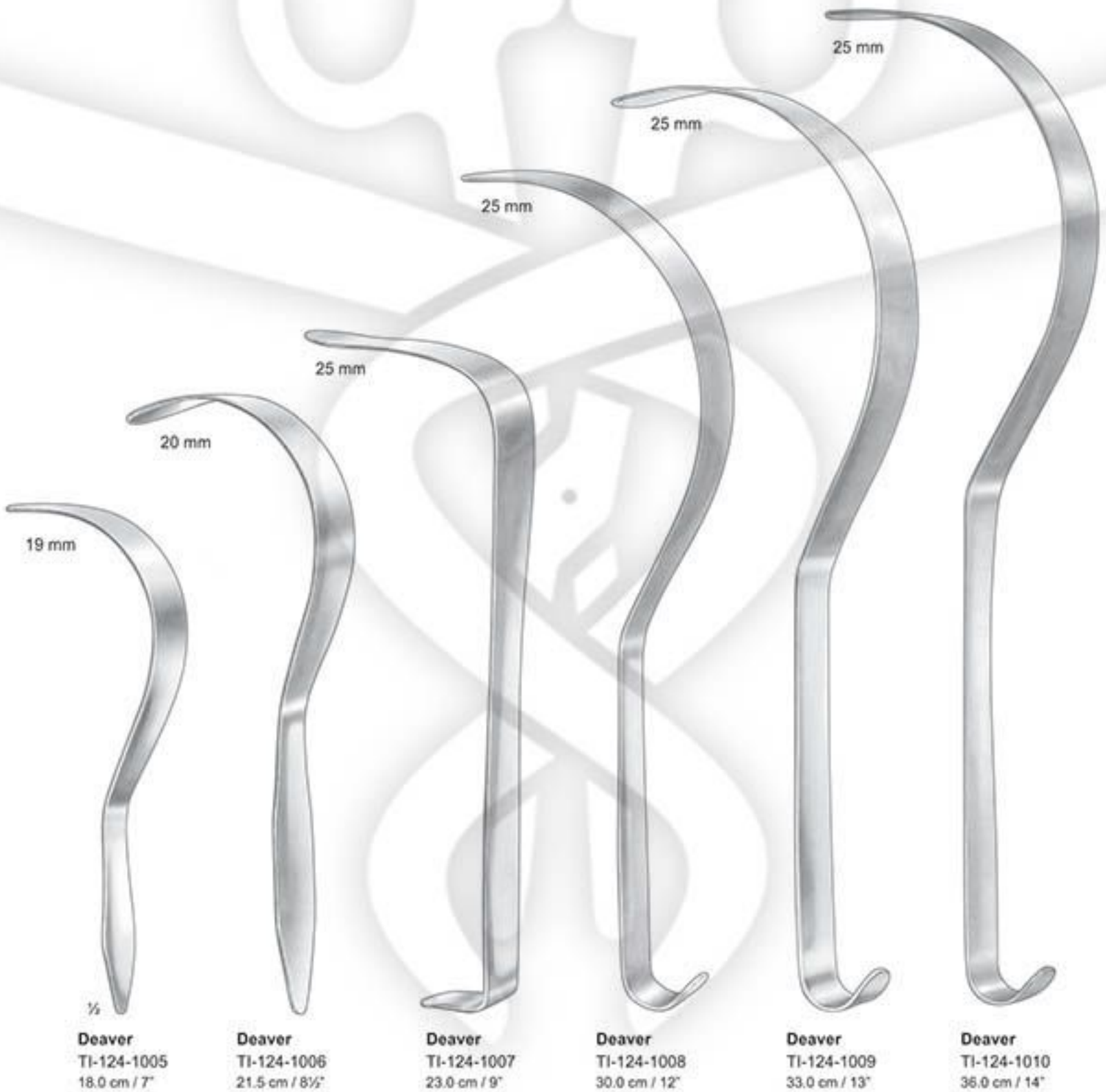

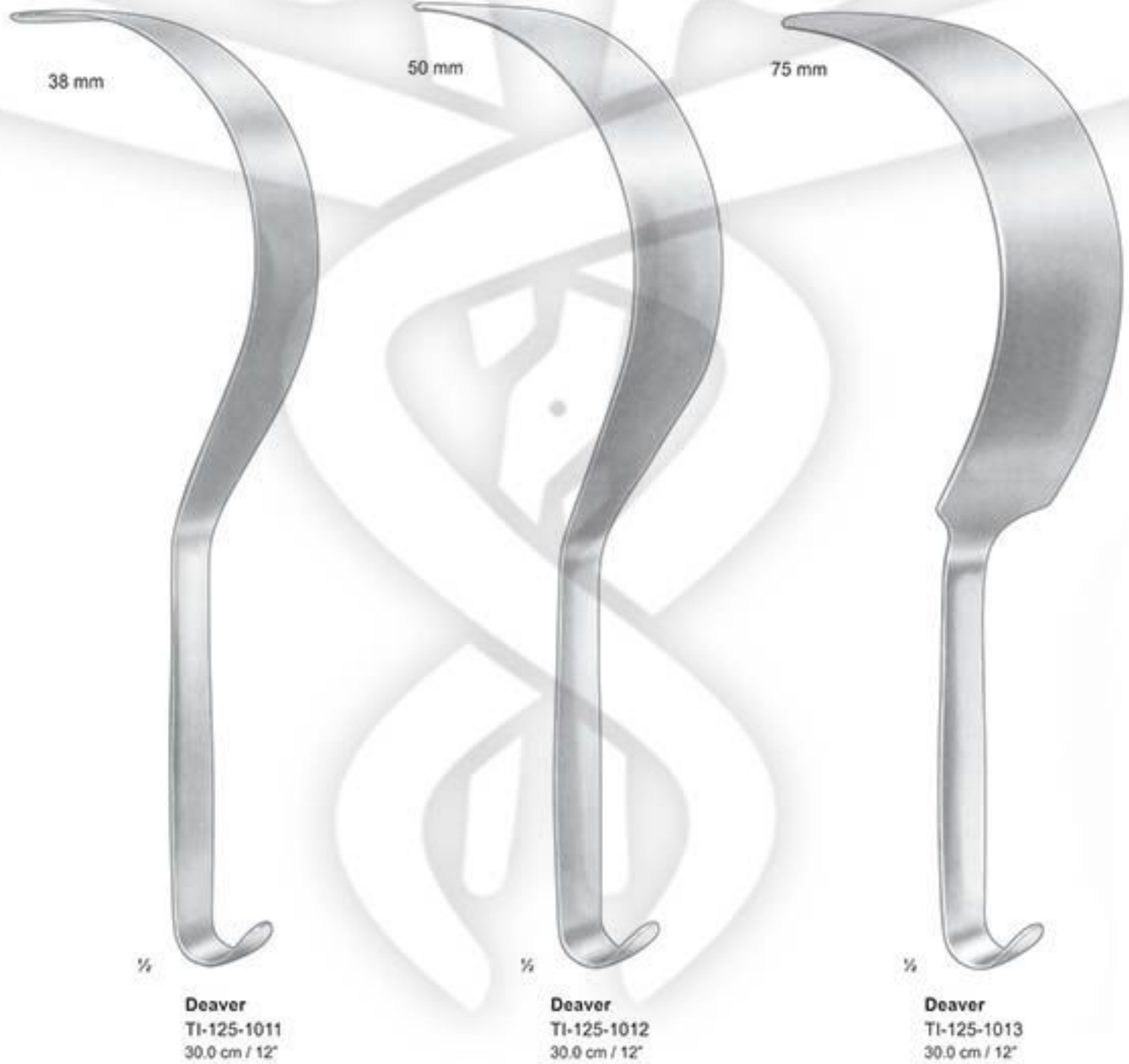



1/2

Deaver
31.0 cm / 12 1/4"



25 mm
TI-126-1014



38 mm
TI-126-1015



50 mm
TI-126-1016

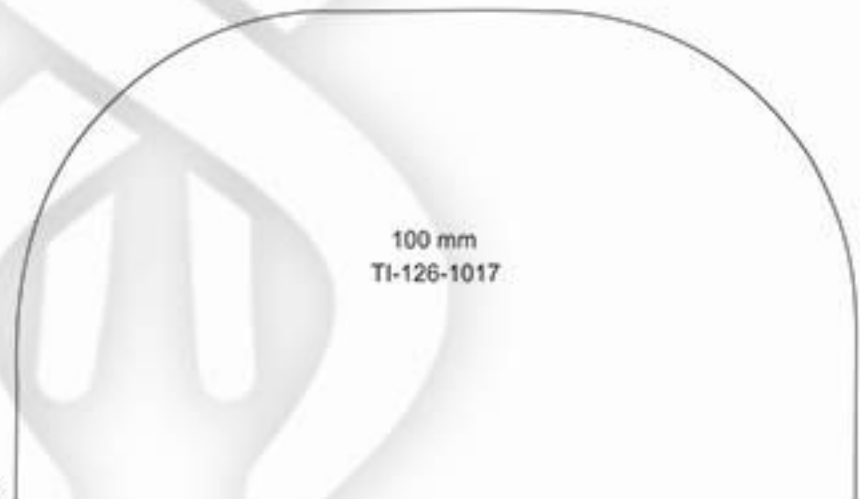

100 mm
TI-126-1017

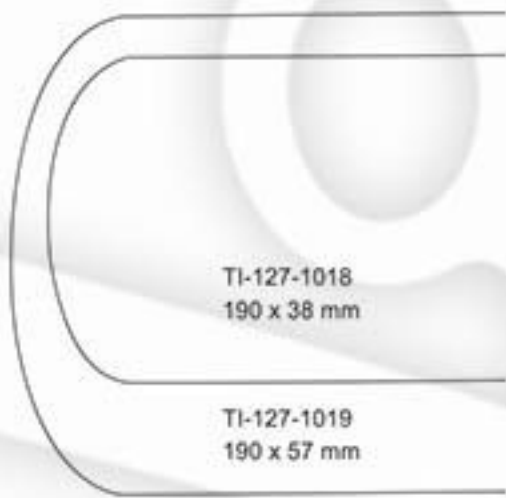

TI-127-1018
190 x 38 mm

TI-127-1019
190 x 57 mm



Fig. 1 = 24 x 20 mm
Fig. 2 = 29 x 26 mm
Fig. 3 = 33 x 29 mm
Fig. 4 = 29 x 24 mm

Fig. 1 = 30 x 28 mm
Fig. 2 = 36 x 36 mm
Fig. 3 = 38 x 43 mm
Fig. 4 = 45 x 28 mm

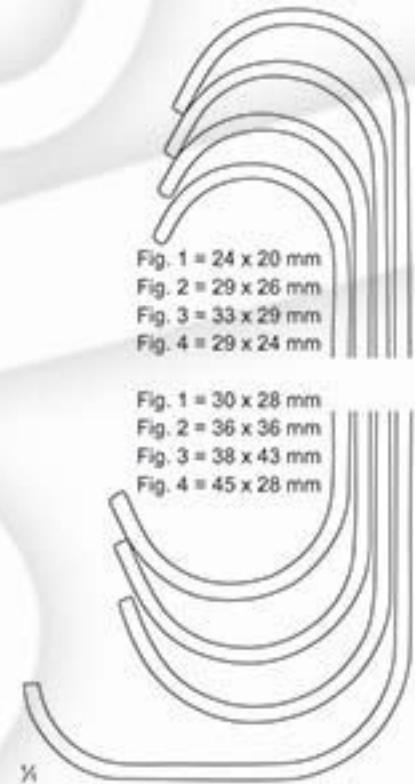

Roux

TI-127-1020 - Set of three 3 (Fig. 1-3)

TI-127-1021 - Fig. 1 = 14.0 cm / 5½"

TI-127-1022 - Fig. 2 = 15.0 cm / 6"

TI-127-1023 - Fig. 3 = 17.0 cm / 6¾"

TI-127-1024 - Fig. 4 = 18.0 cm / 7"



½

Kelly
27.0 cm / 10½"

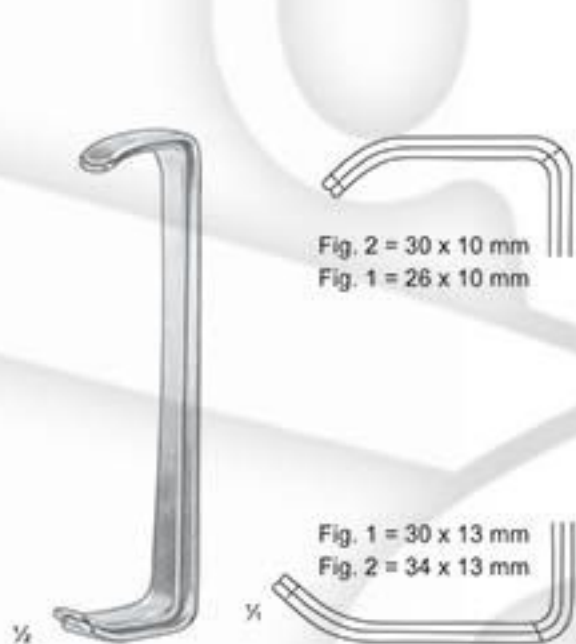

Farabeuf
TI-128-1025 - Set of two
12.0 cm / 4 3/4"

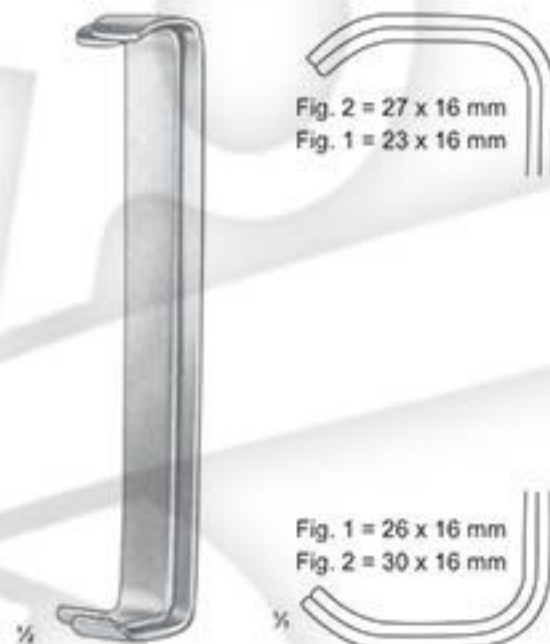

Farabeuf
TI-128-1026 - Set of two
15.0 cm / 6"

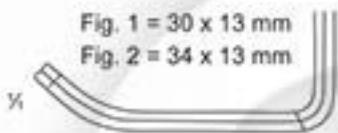

Fig. 1 = 30 x 13 mm
Fig. 2 = 34 x 13 mm

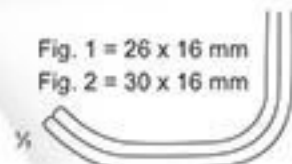

Fig. 1 = 26 x 16 mm
Fig. 2 = 30 x 16 mm



Mini-Roux
TI-128-1027
14.0 cm / 5 1/2"



Baby-Roux
TI-128-1028
13.0 cm / 5 1/4"

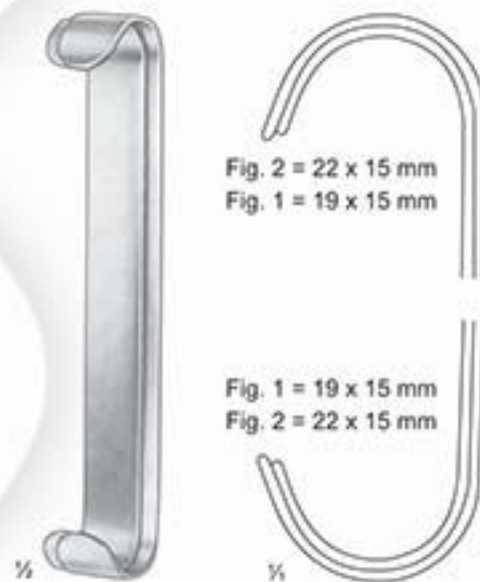

Parker
TI-128-1029 - Set of two
13.5 cm / 5 1/4"

Fig. 2 = 22 x 15 mm
Fig. 1 = 19 x 15 mm

Fig. 1 = 19 x 15 mm
Fig. 2 = 22 x 15 mm

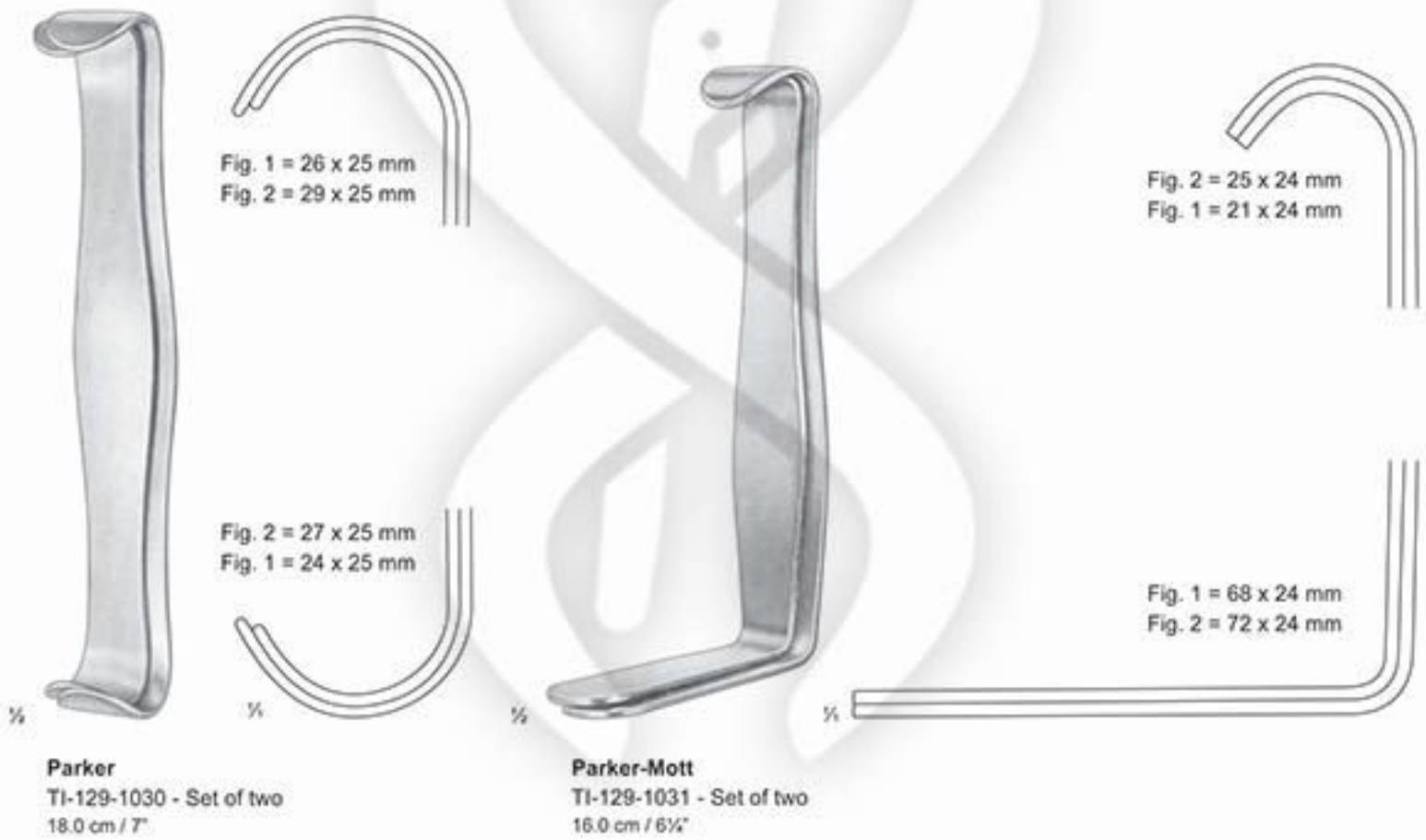

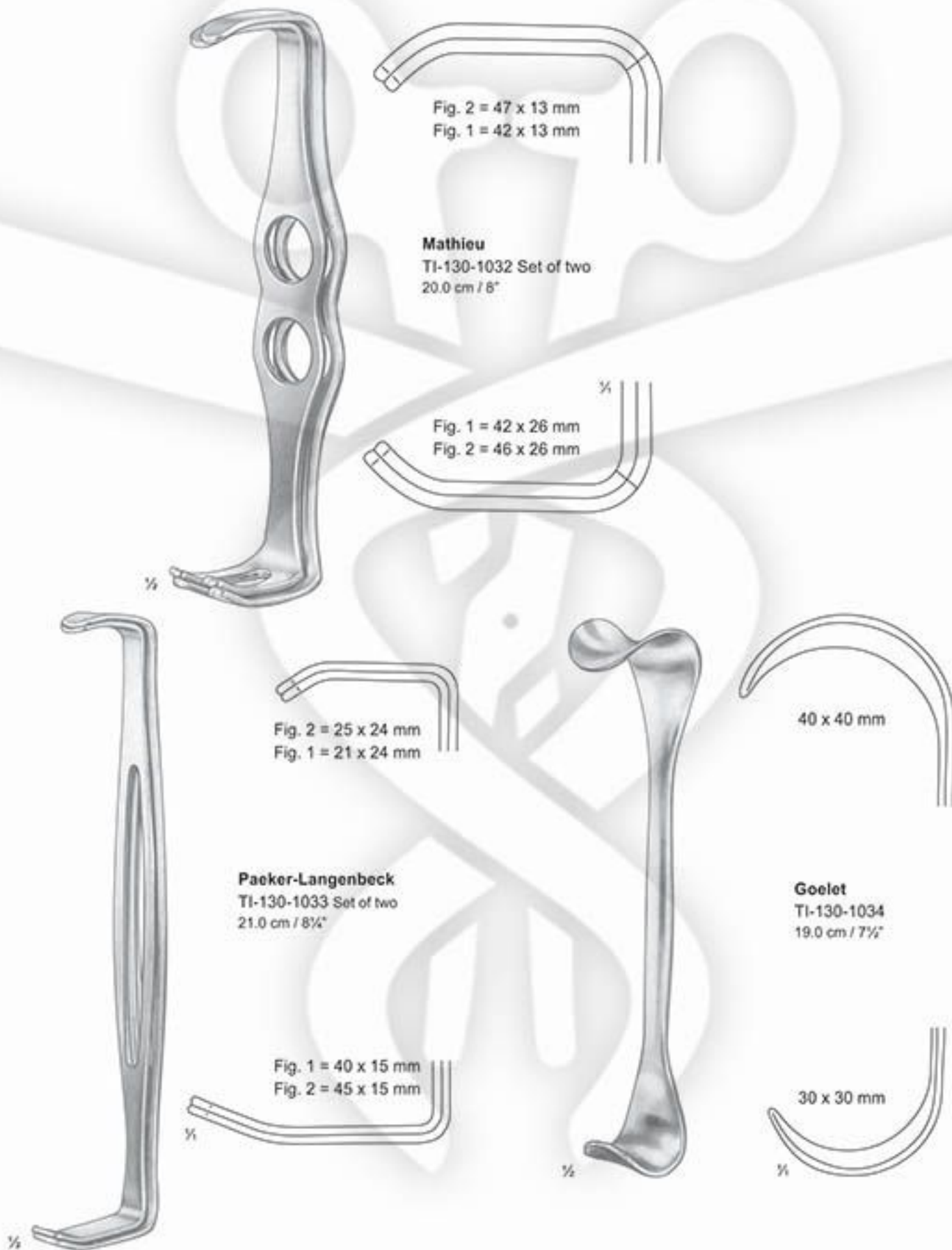



Finsen
5.0 cm / 2"
3 x 4 teeth



TI-131-1035

sharp



TI-131-1036

blunt



TI-131-1037

sharp



TI-131-1038

blunt



Special Model
7.0 cm / 2 3/4"
3 x 4 teeth



TI-131-1039

sharp



TI-131-1040

blunt

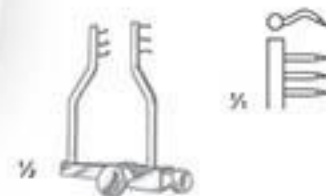

Logan
TI-131-1041
4.0 cm / 1 1/2"
3 x 3 teeth



Buckley
TI-132-1042
6.0 cm / 2 1/4"
3 x 3 teeth
sharp



TI-132-1043
8.0 cm / 3 1/4"
3 x 3 teeth



TI-132-1044
10.0 cm / 4"
4 x 4 teeth
blunt



Alm
4 x 4 teeth



TI-132-1045
7.0 cm / 2 3/4"
sharp

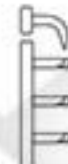

TI-132-1046
10.0 cm / 4"
sharp

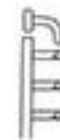

TI-132-1047
7.0 cm / 2 3/4"
blunt



TI-132-1048
10.0 cm / 4"
semi sharp

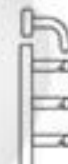

TI-132-1049
10.0 cm / 4"
blunt



1/2

Jansen
10.0 cm / 4"
3 x 3 teeth



1/2

TI-133-1050
sharp



TI-133-1051
with 1 sharp and
2 blunt prongs each



TI-133-1052
blunt



1/2

Scalp Contour
14.0 cm / 5 1/2"
3 x 4 teeth



1/2

TI-133-1053
sharp



TI-133-1054
blunt



Anderson-Adson



TI-134-1055
19.5 cm / 7 3/4"
4 x 4 teeth



Weitlaner
20.0 cm / 8"

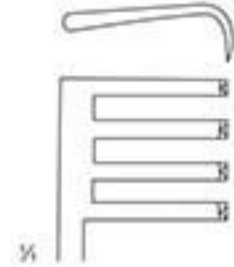



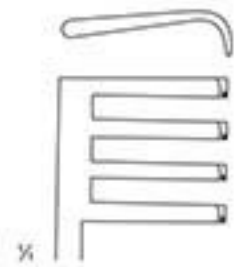

TI-134-1056
sharp

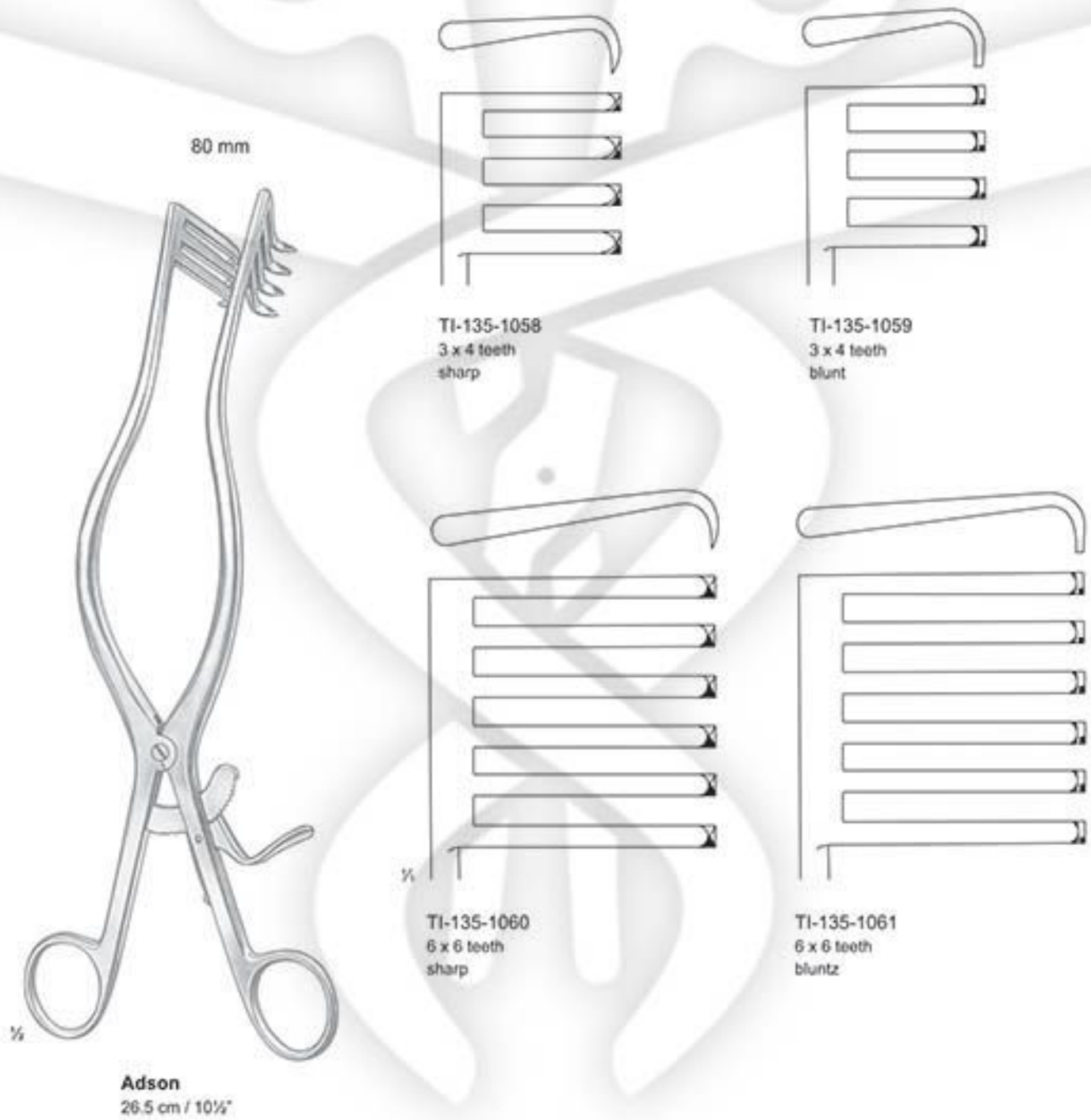

TI-134-1057
blunt

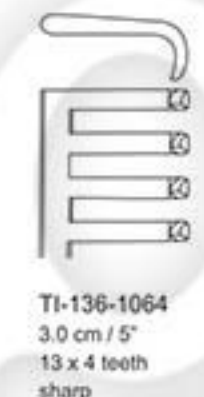
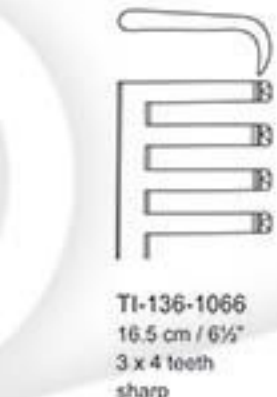
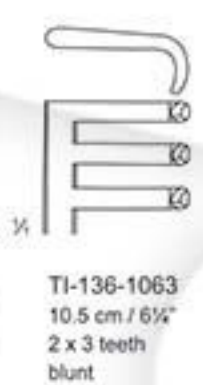
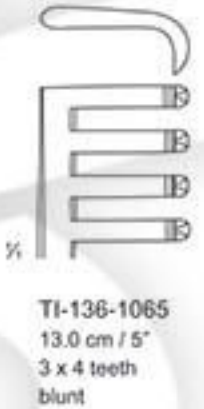
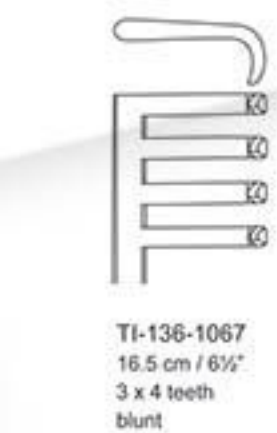
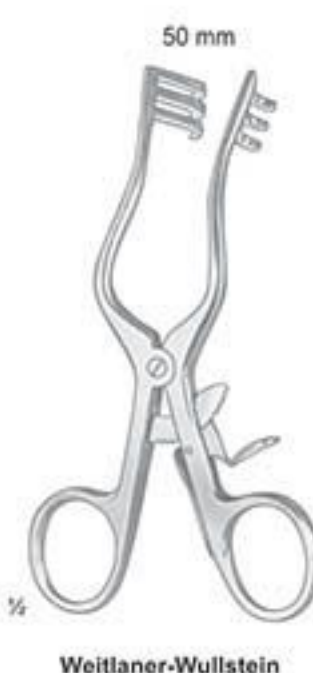

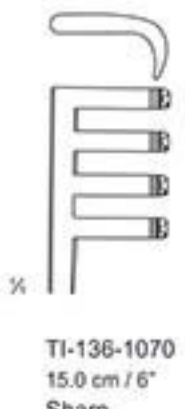
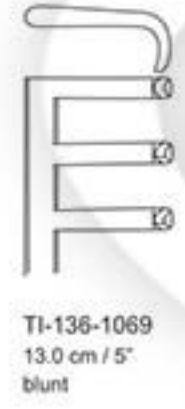
 <p>35 mm</p> <p>1/2</p> <p>Weitlaner-Loktite</p>	 <p>TI-136-1062 10.5 cm / 6 1/4" 2 x 3 teeth sharp</p>	 <p>65 mm 80mm</p> <p>1/2</p>	 <p>TI-136-1064 3.0 cm / 5" 13 x 4 teeth sharp</p>	 <p>TI-136-1066 16.5 cm / 6 1/2" 3 x 4 teeth sharp</p>
	 <p>TI-136-1063 10.5 cm / 6 1/4" 2 x 3 teeth blunt</p>		 <p>TI-136-1065 13.0 cm / 5" 3 x 4 teeth blunt</p>	 <p>TI-136-1067 16.5 cm / 6 1/2" 3 x 4 teeth blunt</p>
 <p>50 mm</p> <p>1/2</p> <p>Weitlaner-Wullstein</p>	 <p>TI-136-1068 13.0 cm / 5" sharp</p>	 <p>1/2</p> <p>Mollison</p>	 <p>TI-136-1070 15.0 cm / 6" Sharp</p>	
	 <p>TI-136-1069 13.0 cm / 5" blunt</p>			



Plester



TI-137-1071
13.0 cm / 5"
2 x 2 teeth
blunt

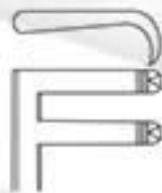

TI-137-1072
13.0 cm / 5"
2 x 2 teeth
sharp



Plester



TI-137-1073
11.0 cm / 4 1/4"
2 teeth
blunt



Plester

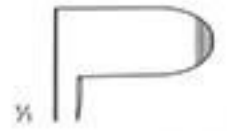

TI-137-1074
11.0 cm / 4 1/4"
2 teeth
blunt

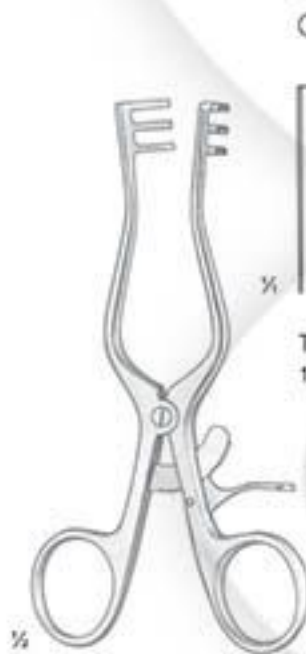

Milligan

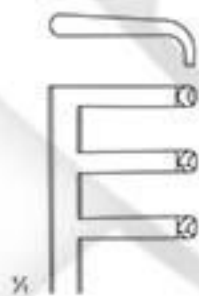

TI-137-1075
13.0 cm / 5"



Weitlaner-Baby



TI-137-1076
13.0 cm / 5"



TI-138-1077
sharp



TI-138-1078
blunt



Henley
16.5 cm / 6½"
3 x 4 teeth



TI-138-1079
16 mm x 19 mm
¾" x ¾"



TI-138-1080
16 mm x 25 mm
¾" x 1"



TI-138-1081
16 mm x 32 mm
¾" x 1¼"

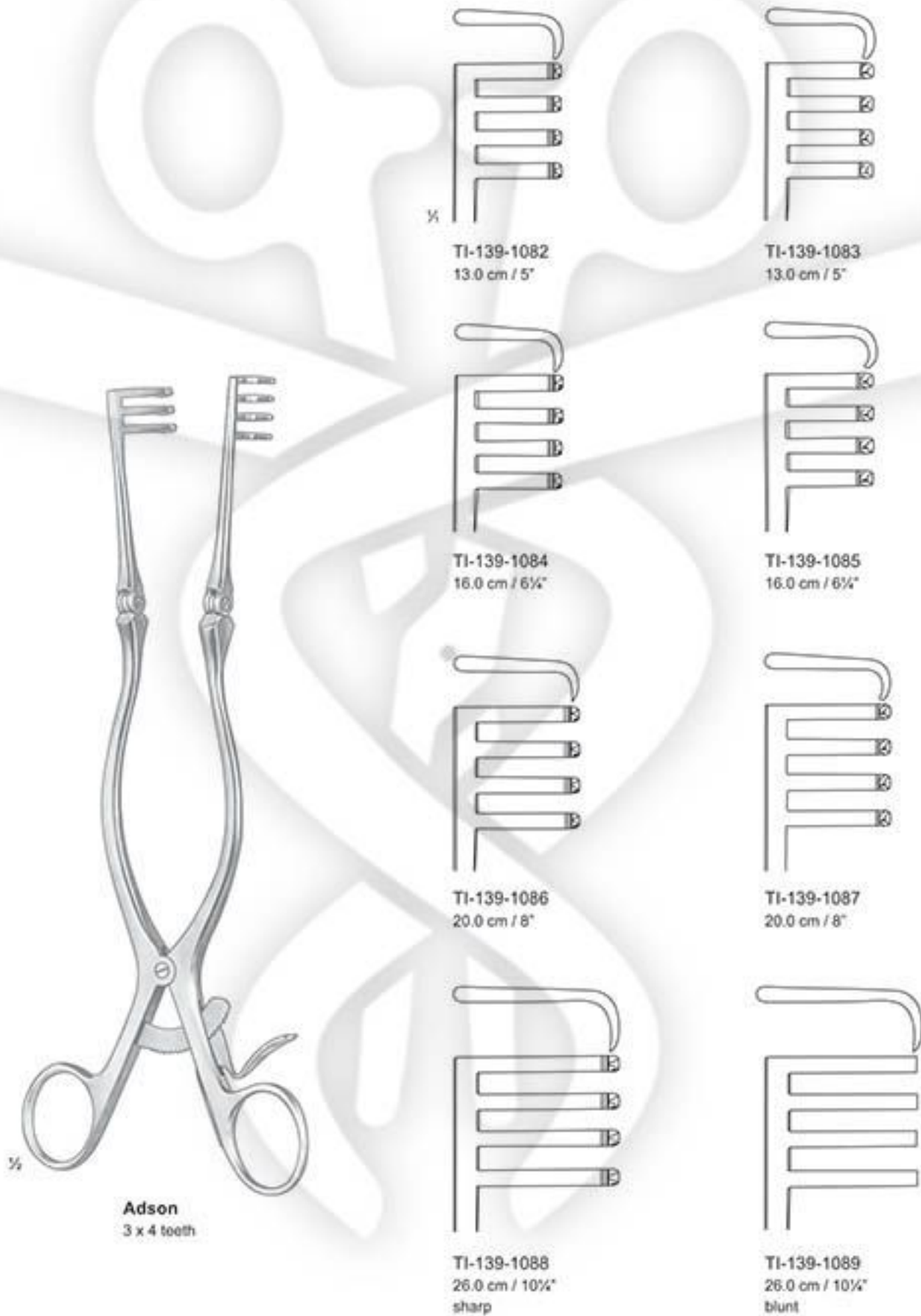

EXCHANGEABLE BLADES

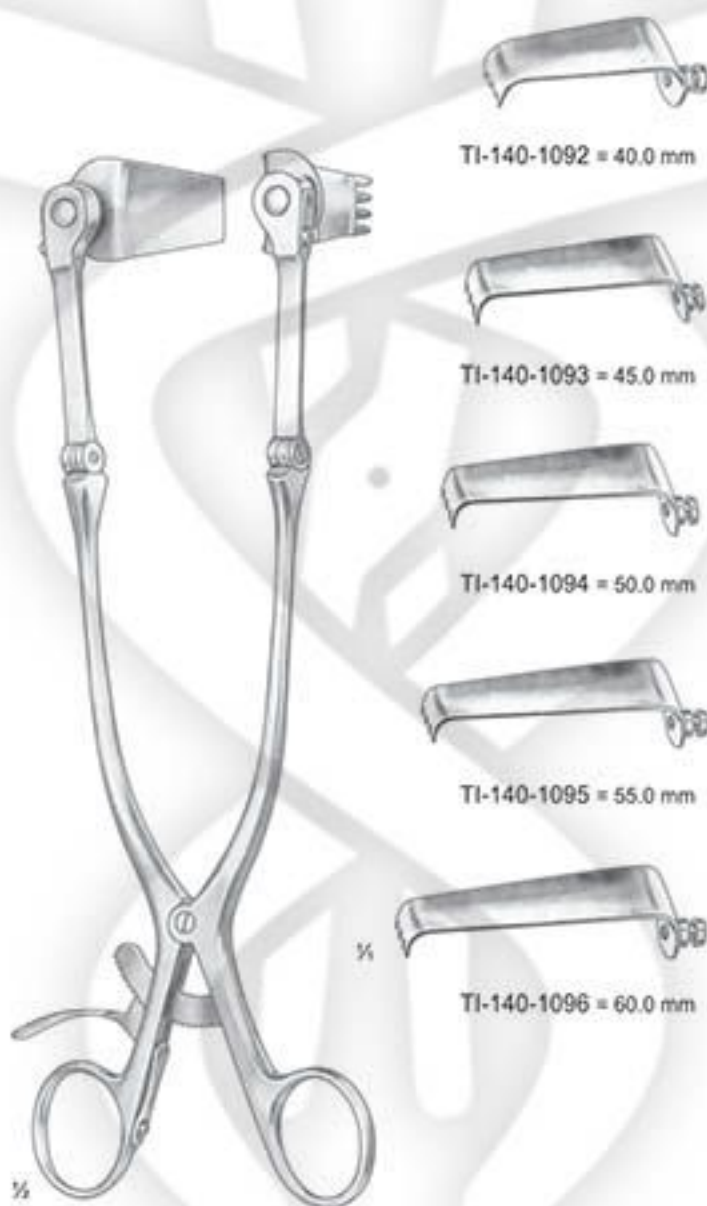

Cloward
 TI-140-1090 Retractor without blades
 25.0 cm / 10"
 TI-140-1091 Retractor complete with two blades
 25.0 cm / 10"

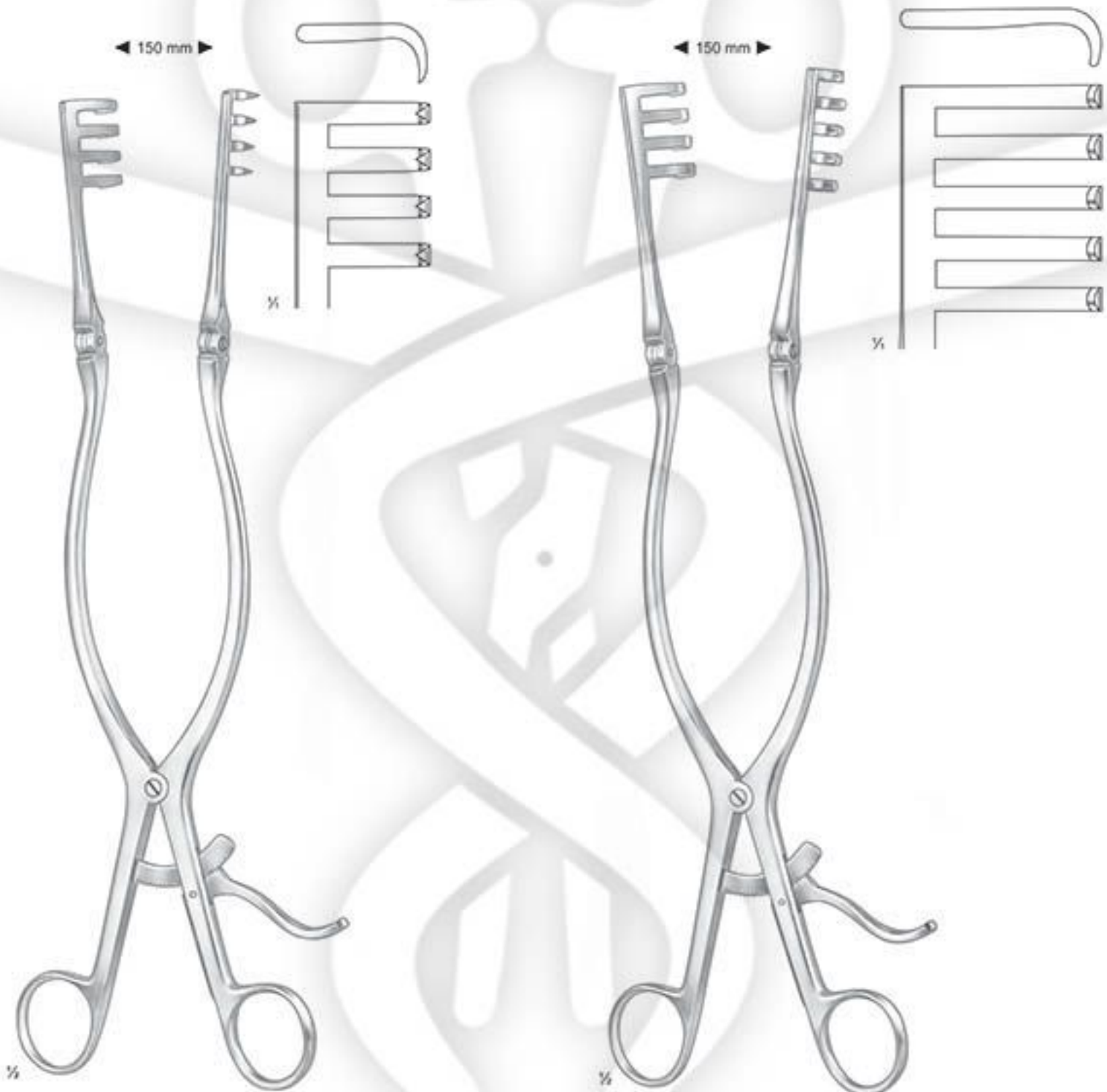

Beckmann
TI-141-1097
31.0 cm / 12 $\frac{1}{2}$ "
4 x 4 teeth

Adson
TI-141-1098
32.0 cm / 12 $\frac{1}{2}$ "
4 x 5 teeth



Beckmann-Adson
31.0 cm / 12¼"
4 x 4 teeth



TI-142-1099
blunt



TI-142-1100
blunt



TI-142-1101
sharp



TI-142-1102
sharp

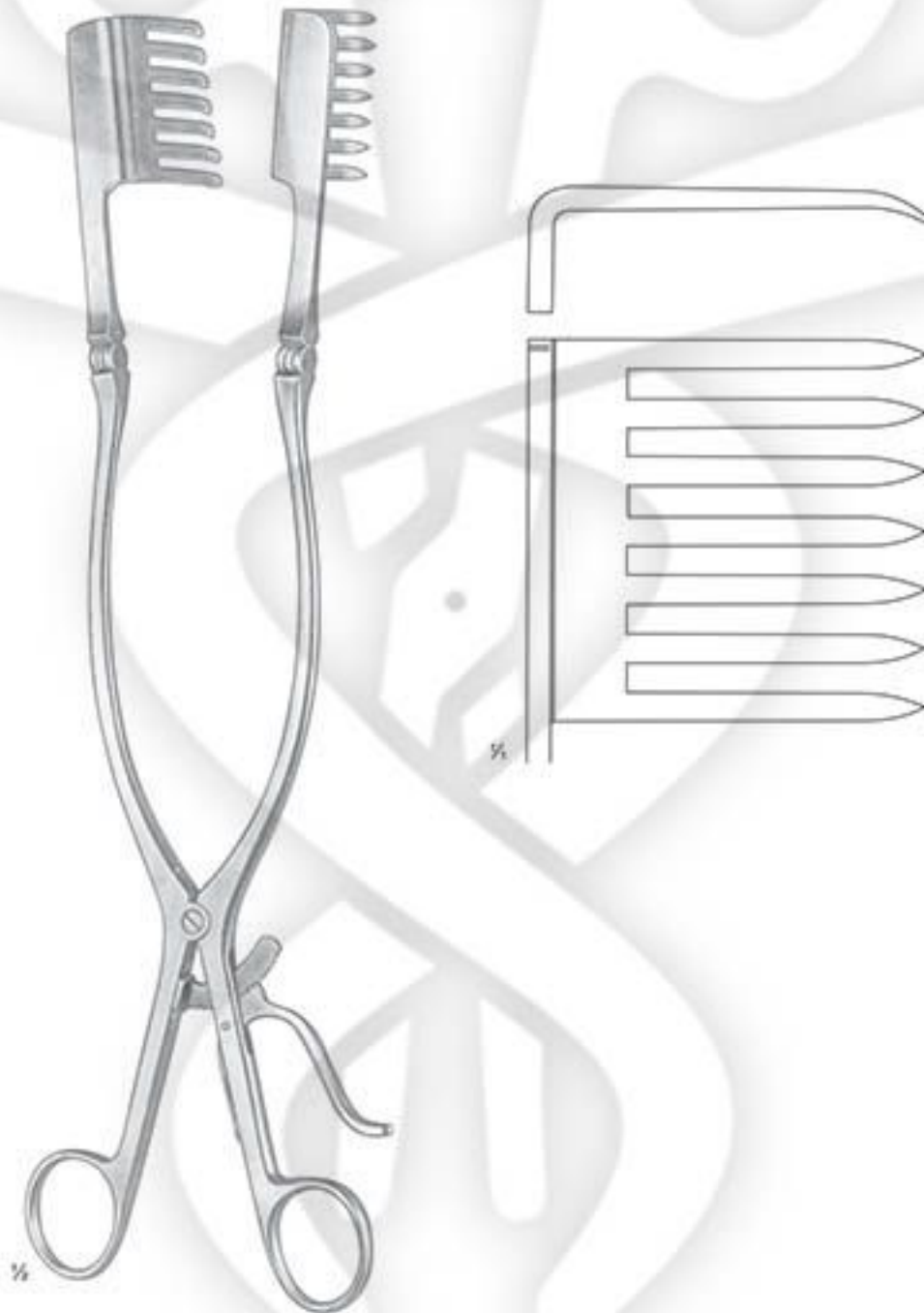

Beckmann-Eaton
TI-143-1103
32.0 cm / 12 $\frac{1}{2}$ "



Hemi-Laminectomy
27.0 cm / 10 $\frac{1}{2}$ "
6 x 6 teeth

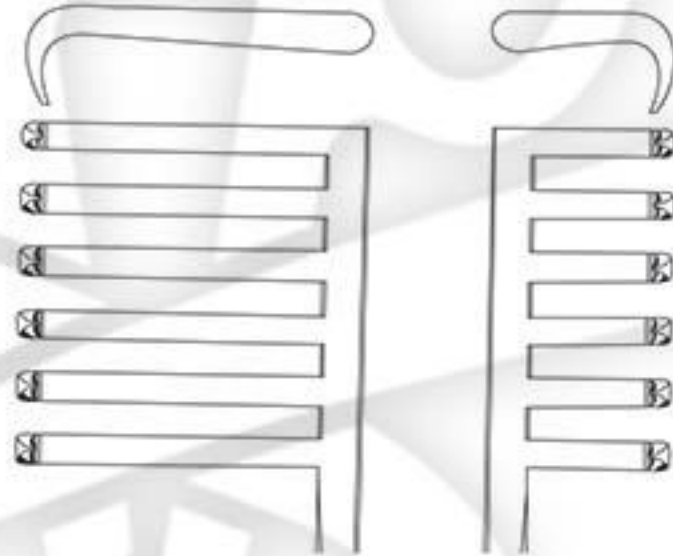

TI-144-1104

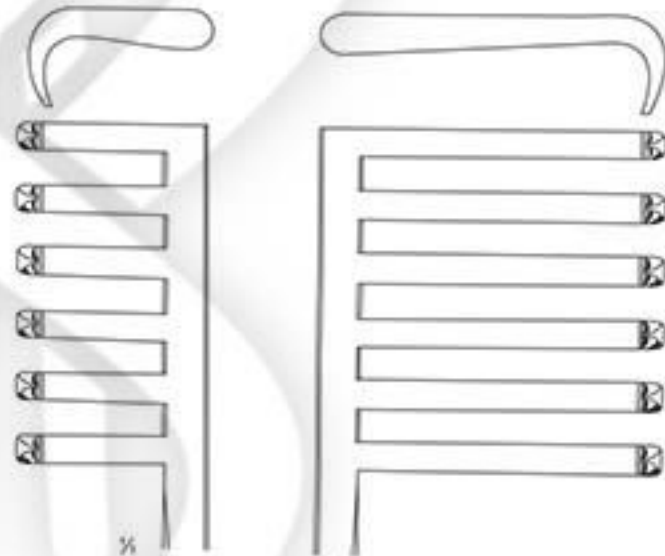

TI-144-1105

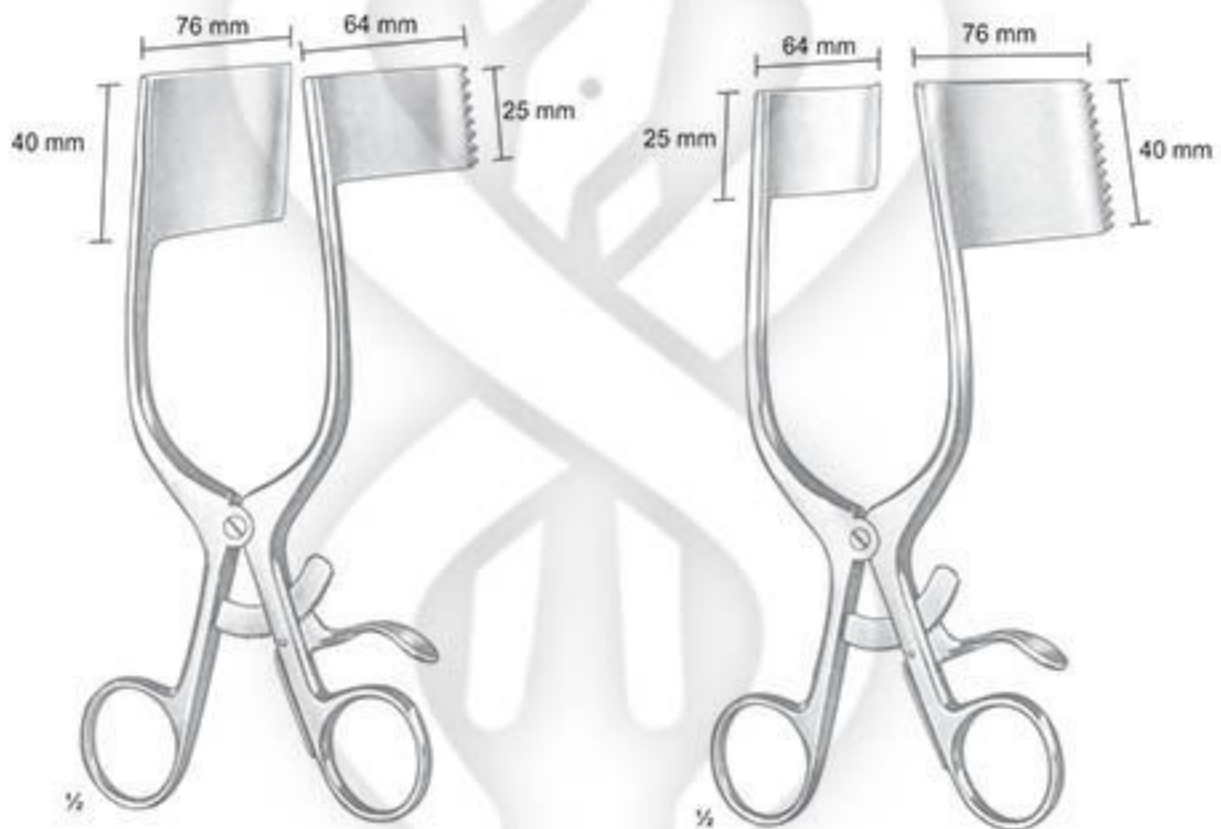

Darling
TI-145-1106
18.0 cm / 7"
(Poplitea)

Darling
TI-145-1107
18.0 cm / 7"
(Poplitea)



Gelpi-Loktite
TI-146-1108
13.0 cm / 5"

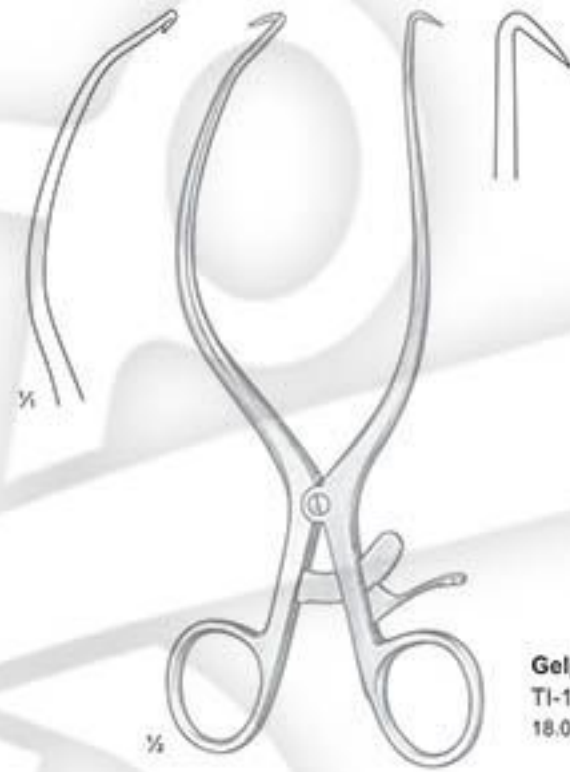

Gelpi-Loktite
TI-146-1109
18.0 cm / 7"

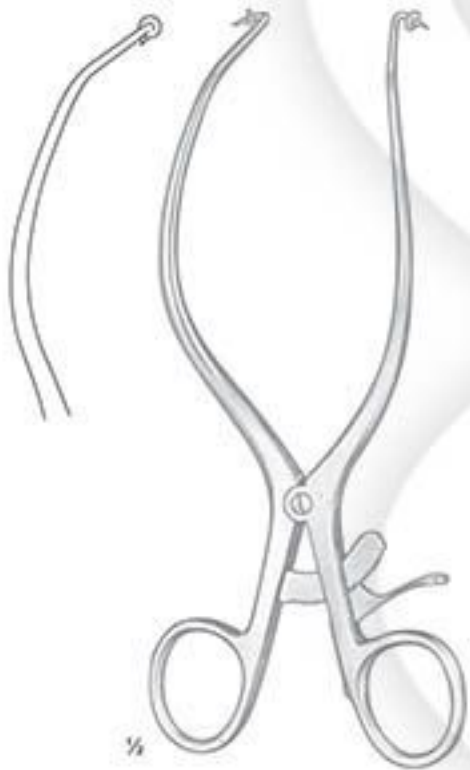

Gelpi-Loktite
TI-146-1110
18.0 cm / 7"



Gelpi-Seiletz
TI-146-1111
15.0 cm / 6"

EXCHANGEABLE BLADES

Measurements of blades: Depth x width

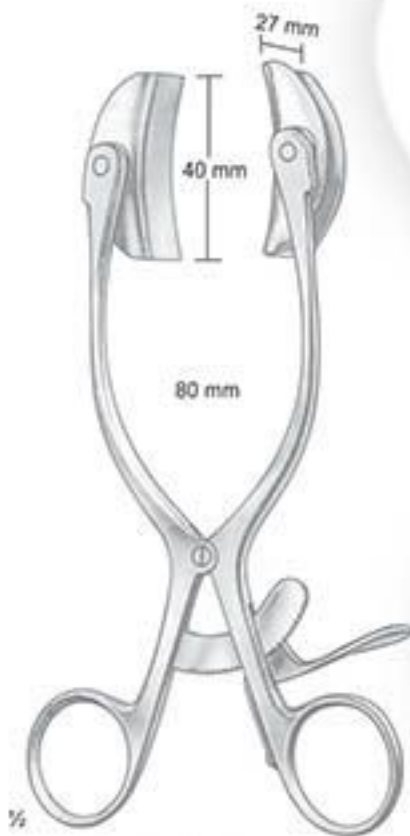

Baby-Collin
TI-147-1112
complete, with 2 pairs of blades



Collin
TI-147-1113
complete, with 1 pairs of blades 38 x 60 mm

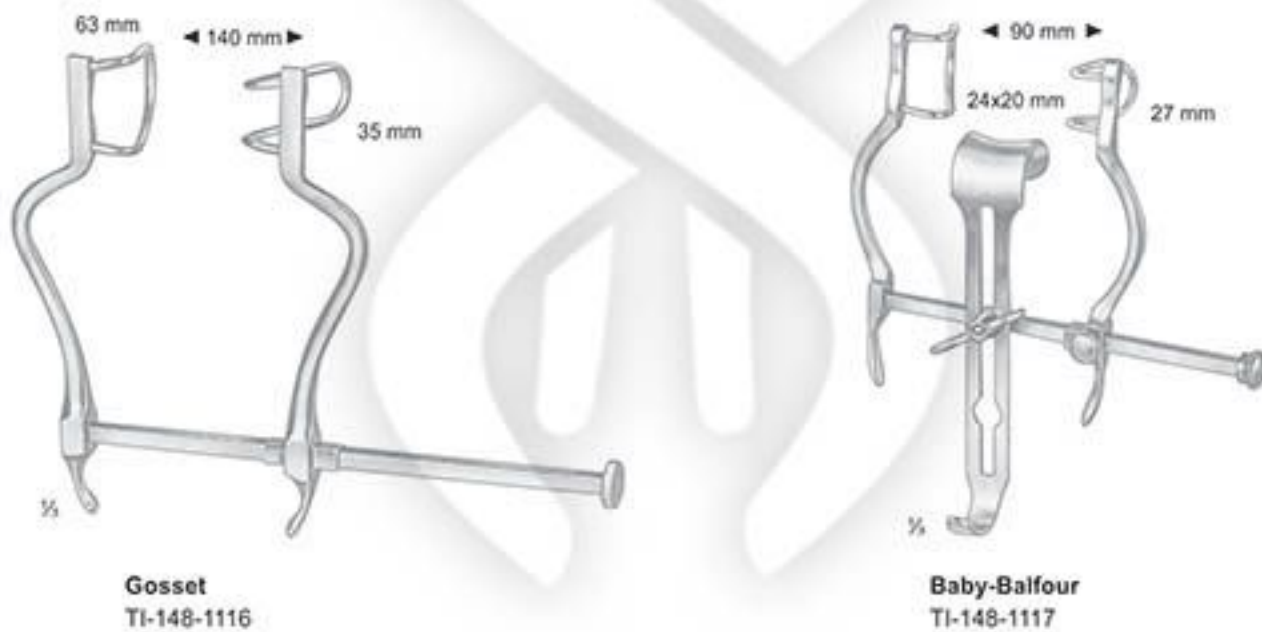
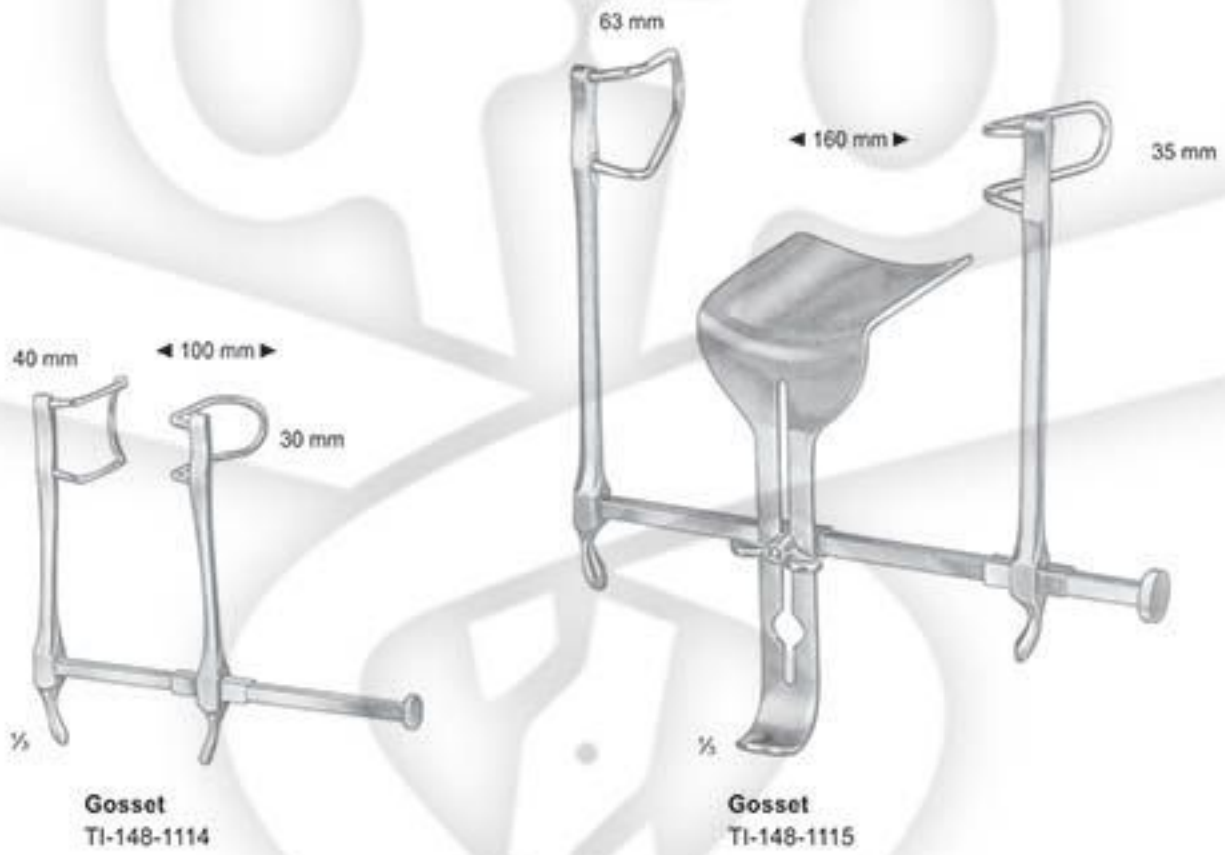

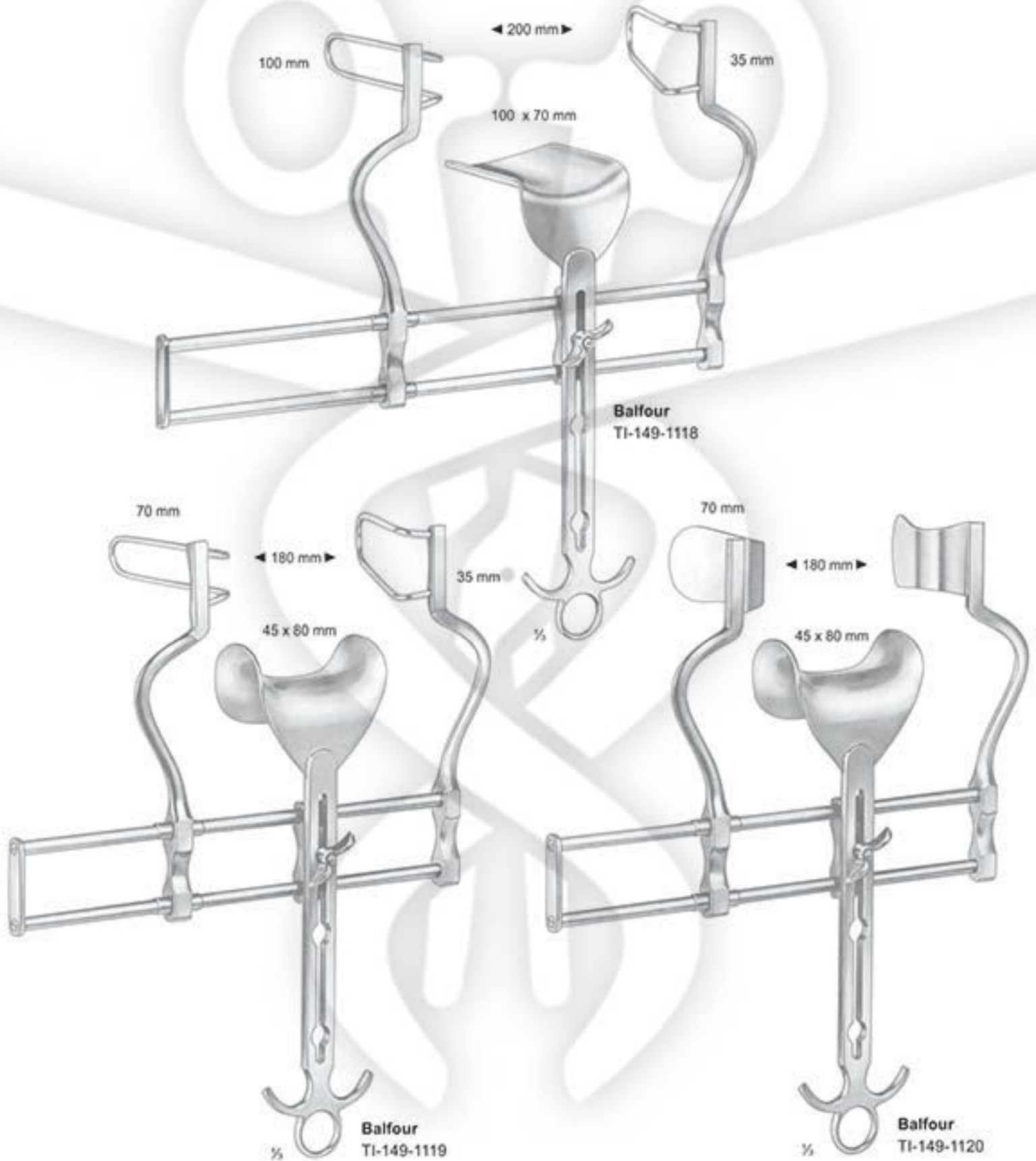

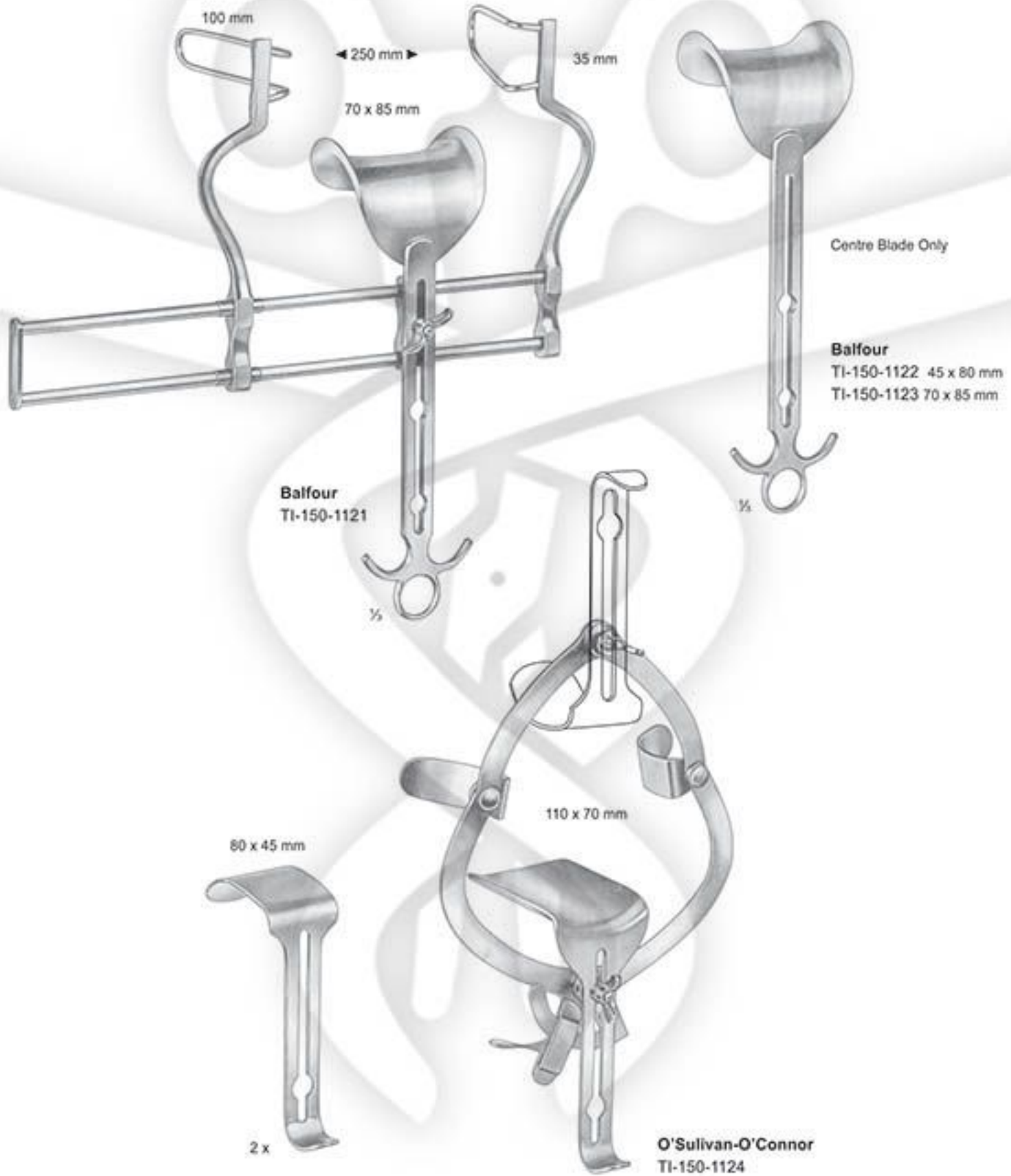



Reverdin
TI-151-1125
28.0 cm / 11"



Ribbon
TI-151-1126 33.0 cm / 13", 30 mm
TI-151-1127 33.0 cm / 13", 40 mm
TI-151-1128 33.0 cm / 13", 50 mm

flexible



Haberer
TI-151-1129 20.0 cm / 8", 18/25 mm
TI-151-1130 28.0 cm / 11", 25/30 mm
TI-151-1131 30.0 cm / 12", 45 mm

flexibles



Special Model Soft
TI-151-1132 20.0 cm x 12mm
TI-151-1133 20.0 cm x 17 mm
TI-151-1134 25.0 cm x 25 mm

malleable and very soft

- TI-151-1135 20.0 cm x 6,5 mm
- TI-151-1136 20.0 cm x 9,5 mm
- TI-151-1137 20.0 cm x 13 mm
- TI-151-1138 20.0 cm x 16 mm
- TI-151-1139 20.0 cm x 19 mm
- TI-151-1140 20.0 cm x 25 mm

02

DIAGNOSTICS INSTRUMENTS





Rabiner
TI-152-1141
23.0 cm / 9"
40 mm ø

Buck
TI-152-1142
18.0 cm / 7"

Buck
TI-152-1143
18.0 cm / 7"

Special-Mobile
TI-152-1144
19.0 cm / 7½"



1/2

Troemner
TI-153-1145
24.0 cm / 9 1/2"



1/2

**Neuro-Duoflex
Mod. Dejerine**
TI-153-1146
22.0 cm / 8 1/2"



1/2

Dejerine
TI-153-1147
20.0 cm / 8"



1/2

Dejerine
TI-153-1148
21.0 cm / 8 1/4"



1/2

**Taylor
Mod. USA**
TI-153-1149
20.0 cm / 8"



1/2

Berliner
TI-153-1150
20.0 cm / 8"



Aly
TI-154-1151
17.0 cm / 6 $\frac{3}{4}$ "



Wartenberg
TI-154-1152
19.0 cm / 7 $\frac{1}{2}$ "



Weber
TI-154-1153
9.0 cm / 3 $\frac{1}{2}$ "



Pinard
TI-154-1154
18.0 cm / 7"



Pinard
TI-154-1155
15.0 cm / 6"

03

VACCINATION & PUNCTURE INSTRUMENTS





Universal
TI-155-1156
Set of 3 Pieces

TI-155-1157
Set of 4 Pieces



Standard
11.0 cm / 4 1/4"
TI-155-1158 = 3 mm ø
TI-155-1159 = 4 mm ø
TI-155-1160 = 5 mm ø
TI-155-1161 = 6 mm ø



Standard
12.0 cm / 4 3/4"
TI-155-1162 = 3 mm ø
TI-155-1163 = 4 mm ø
TI-155-1164 = 5 mm ø
TI-155-1165 = 6 mm ø



Standard
12.0 cm / 4 3/4"
TI-155-1166 = 3 mm ø
TI-155-1167 = 4 mm ø
TI-155-1168 = 5 mm ø
TI-155-1169 = 6 mm ø



Duke
TI-156-1170
11.0 cm / 4 1/2"
5.5 mm / ø



Nelson
21.0 cm / 8 1/4"



TI-156-1171 TI-156-1172 TI-156-1173



Campbell
16.0 cm / 6 1/2"



TI-156-1174
6 mm / ø



TI-156-1175
8 mm / ø



Buelau
TI-156-1176
24.0 cm / 9 1/2"
8 mm ø



1/2
Fleurant
TI-157-1177
23.0 cm / 9"
5 mm ø



1/2
Fleurant
TI-157-1178
23.0 cm / 9"
5 mm ø



1/2
Ochsner
14.0 cm / 5 1/2"
TI-157-1179 = 4 mm ø
TI-157-1180 = 5.5 mm ø
TI-157-1181 = 6.5 mm ø



1/2
Billrot
TI-157-1182
24.0 cm / 10"
6 mm ø



Adson
TI-158-1183
4 mm ø
21.0 cm / 18 1/2"



Frazier
TI-158-1184, BI-158-1187
19.0 cm / 7 1/2"
Fr.
6 TI-158-1184
8 TI-158-1185
10 TI-158-1186
12 TI-158-1187



Frazier
TI-158-1188, BI-014-1189
19.0 cm / 7 1/2"
Fr.
8 TI-158-1188
10 TI-158-1189



Poppen
TI-158-1190, BI-158-1193
13.0 cm / 5"
Fr.
6 TI-158-1190
8 TI-158-1191
10 TI-158-1192
12 TI-158-1193



Poppen
TI-158-1194, BI-158-1195
13.0 cm / 5"
Fr.
8 TI-158-1194
10 TI-158-1195



Wullstein
TI-158-1196
14.0 cm / 5 1/2"



TI-158-1197



TI-158-1198



TI-158-1199

TI-158-1188, TI-158-1189 - with Fiber Optics
TI-158-1194, TI-158-1195 - with Fiber Optics

TI-158-1196 - with Micro suction tube, complete consisting of:

TI-014-1197 - micro suction cannula, ø 0.4 mm
TI-014-1198 - ditto ø 0.6 mm
TI-014-1199 - ditto ø 0.8 mm

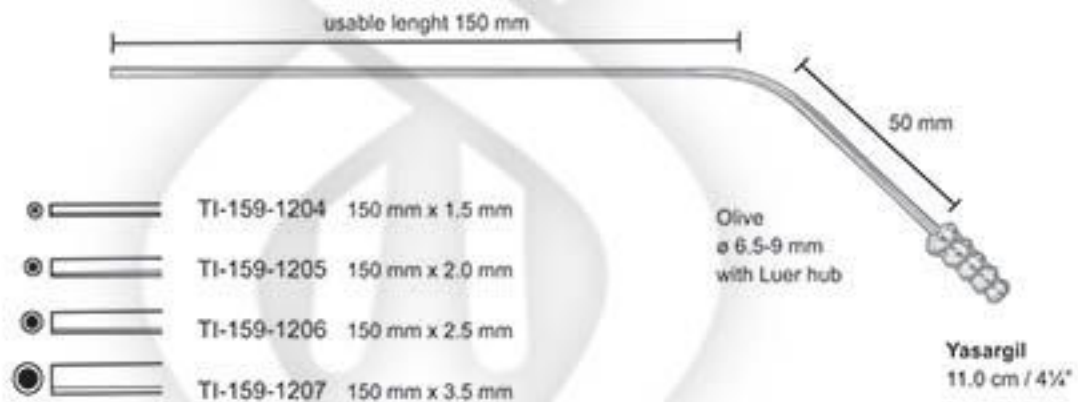
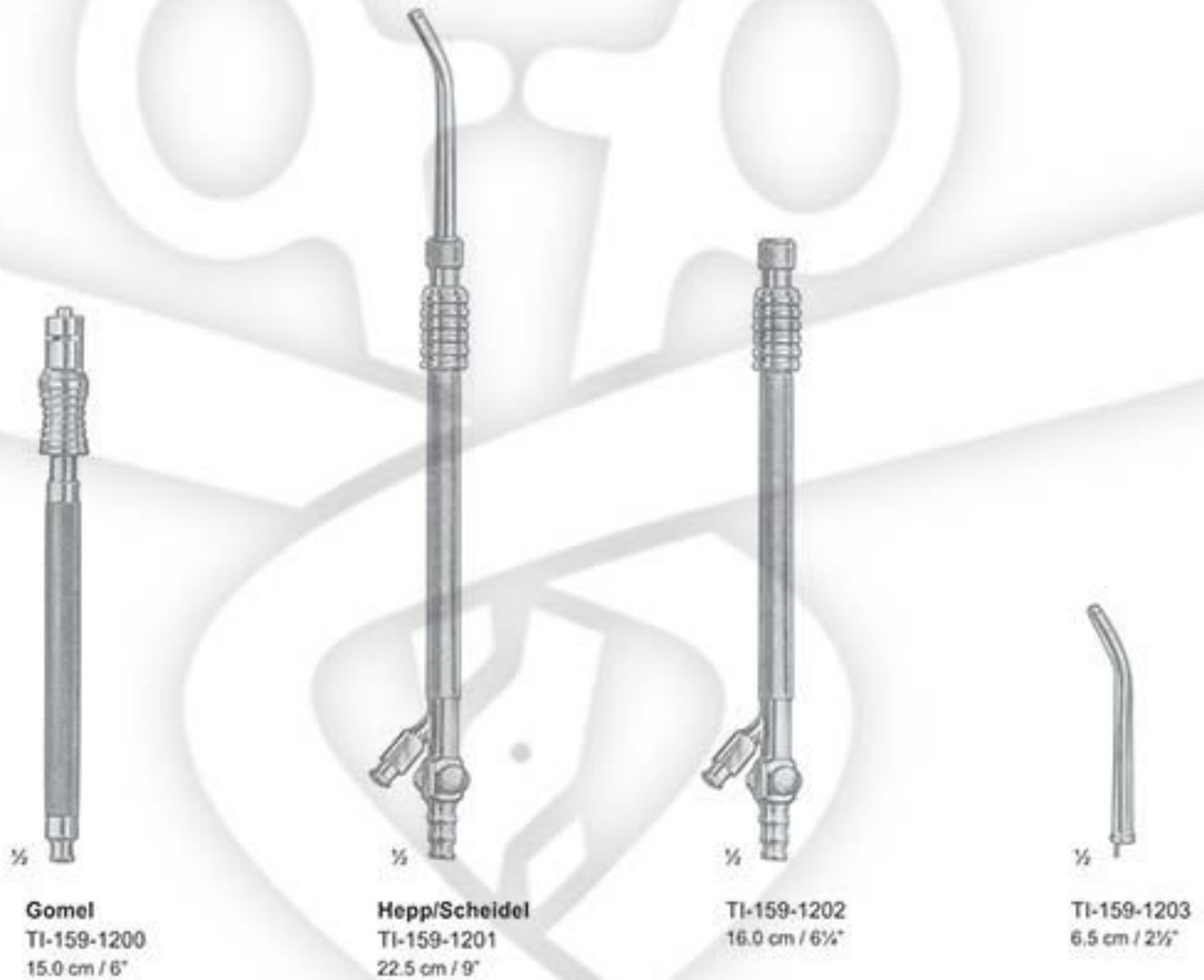

Irrigator for Microsurgery
Irrigator/Aspirator complete with cannula
Irrigator/Aspirator only
Suction and Irrigation, cannula only

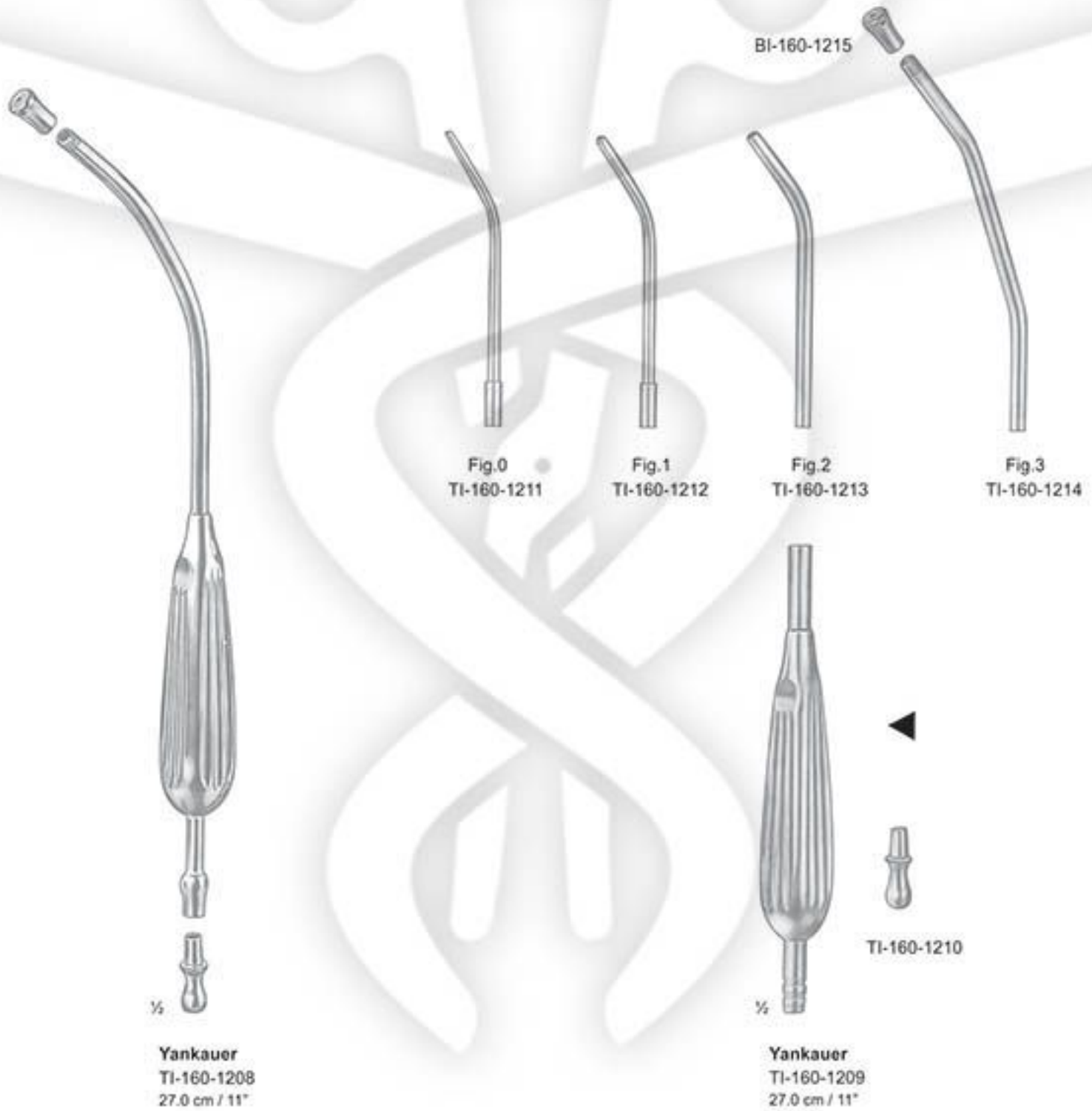

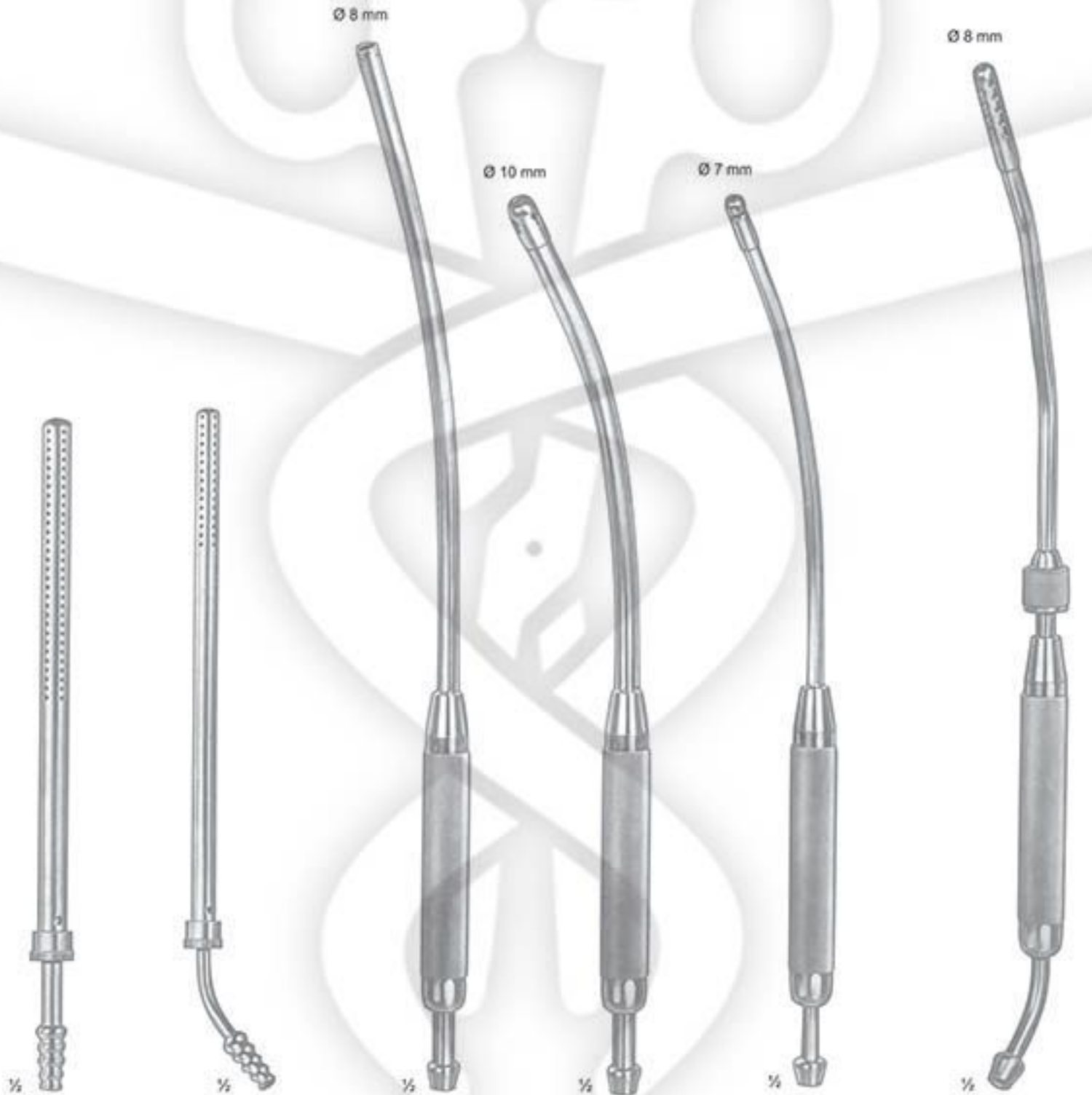

Pooler
 TI-161-1216
 22.0 cm / 8 3/4", 10 mm ø
 (Fr.30)

Pooler
 TI-161-1217
 22.0 cm / 8 3/4", 8 mm ø
 (Fr.23)

Cooley
 TI-161-1218
 35.0 cm / 14"

Cooley
 TI-161-1219
 31.0 cm / 12 1/2"

Cooley
 TI-161-1220
 30.0 cm / 12"

Cooley
 TI-161-1221
 33.0 cm / 13 1/4"

6 mm
round

6 mm
oval

- TI-162-1225
1.5 mm ø
- TI-162-1226
2.0 mm ø
- TI-162-1227
2.5 mm ø
- TI-162-1228
3.5 mm ø

- TI-162-1229
1.5 mm ø
- TI-162-1230
2.0 mm ø
- TI-162-1231
2.5 mm ø
- TI-162-1232
3.5 mm ø

with additional side holes

Nuboer
TI-162-1222
21.0 cm / 8¼"

Nuboer
TI-162-1223
21.0 cm / 8¼"

Coupland
TI-162-1224
17.0 cm / 6¾"

- TI-162-1233
1.5 mm ø
- TI-162-1234
2.5 mm ø
- TI-162-1235
3.5 mm ø

2.0 mm ø

Byrd
20.0 cm / 8"

Cogoswell
TI-162-1236
23 cm / 9"

04

SUTURE INSTRUMENTS





TI-163-1237



TI-163-1238

18.0 cm / 7"



TI-163-1239



TI-163-1240

18.0 cm / 7"



Barraquer
TI-163-1241
16.0 cm / 6 1/4"



Barraquer
TI-163-1242
14.0 cm / 5 1/2"



Kalt
TI-163-1243
14.0 cm / 5 1/2"



Barraquer-Troutman
10.0 cm / 4"



Arruga
14.0 cm / 5 1/2"

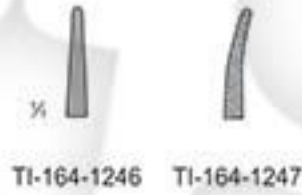

Barraquer-Troutman
10.0 cm / 4"



Barraquer

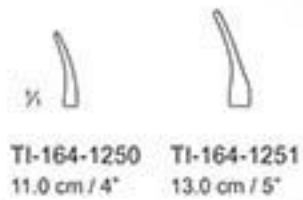

Barraquer
TI-164-1252
14.0 cm / 5 1/2"



TI-164-1253
13.0 cm / 5"



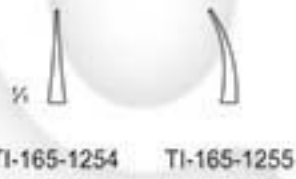

TI-165-1254 TI-165-1255



Castroviejo
9.0 cm / 3 1/2"



TI-165-1256 TI-165-1257



Castroviejo
9.0 cm / 3 1/2"



TI-165-1258 TI-165-1259



Castroviejo
14.0 cm / 5 1/2"

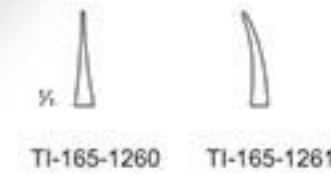

TI-165-1260 TI-165-1261



Castroviejo
14.0 cm / 5 1/2"





TI-167-1270
12.0 cm / 4 3/4"

TI-167-1271
12.5 cm / 5"

Derf



Collier
TI-167-1272
12.5 cm / 5"

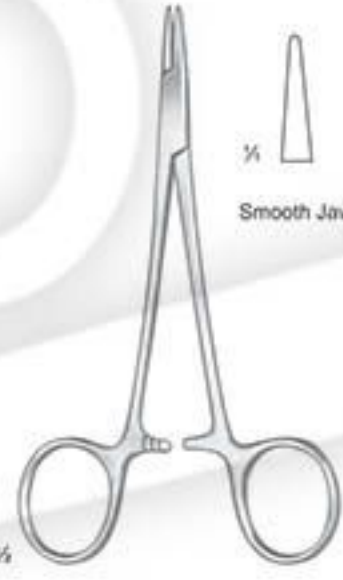

Webster
TI-167-1273
13.0 cm / 5"

Smooth Jaws, with special groove



Halsey
TI-167-1274
13.0 cm / 5"



Neivert
TI-167-1275
13.0 cm / 5"



Hegar-Baumgartner
TI-167-1276
14.0 cm / 5 1/2"



Brown
13.0 cm / 5"
18.0 cm / 7"



Crile-Murray
TI-168-1279
15.0 cm / 6"

Crile-wood
TI-168-1280
15.0 cm / 6"

Adson
TI-168-1281
18.0 cm / 7"

Metzenbaum
TI-168-1282
18.0 cm / 7"



M.G.H (Mass-General-Hospital)



Mayo-Hegar

TI-168-1283
17.0 cm / 6½"

TI-168-1284
14.0 cm / 5½"

TI-168-1285
16.0 cm / 6"

TI-168-1286
18.0 cm / 7"

TI-168-1287
20.0 cm / 8"

TI-168-1288
24.0 cm / 9½"

TI-168-1289
26.0 cm / 10½"

TI-168-1290
30.0 cm / 12"



Mayo-Hegar



TI-169-1291
16.0 cm / 6¼"

TI-169-1292
18.0 cm / 7"

TI-169-1293
20.0 cm / 8"

delicate pattern



Jamison



TI-169-1294
23.5 cm / 9¼"



Masson



TI-169-1295
27 cm / 10½"



Finocchietto
TI-170-1296
27.0 cm / 10½"

Wangensteen
TI-170-1297
27.0 cm / 10½"

Johnson
TI-170-1298
27.0 cm / 10½"

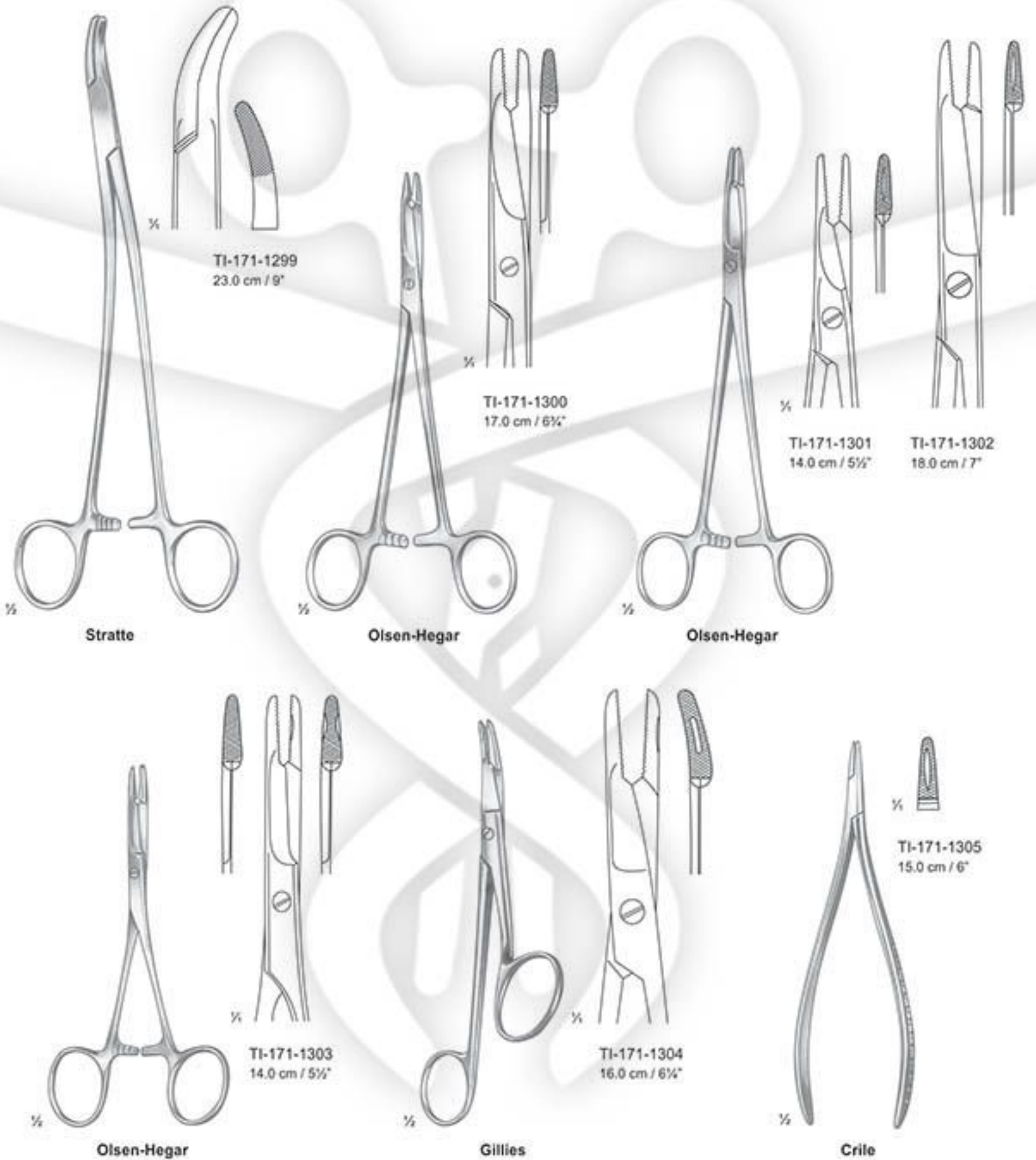



Mathieu



Mathieu

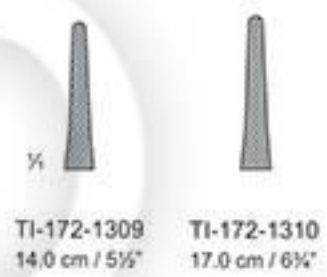

slender jaws



Mathieu

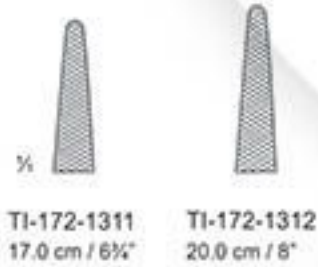

Toennis



Lichtenberg

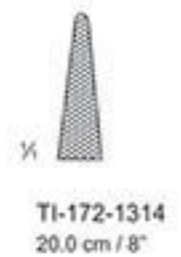

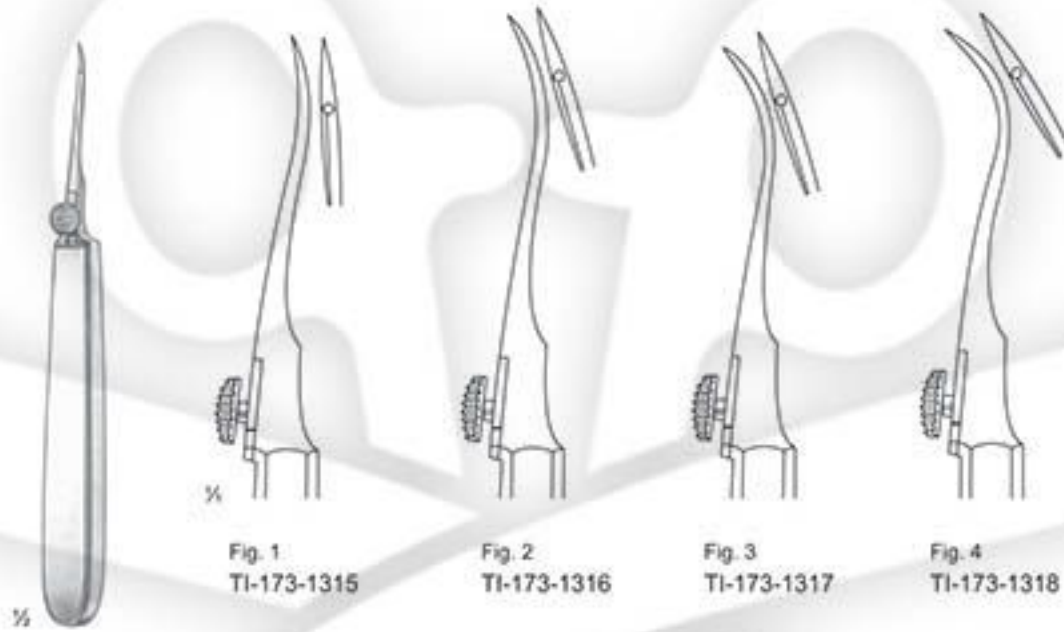

Reverdin
14.0 cm / 5 1/2"

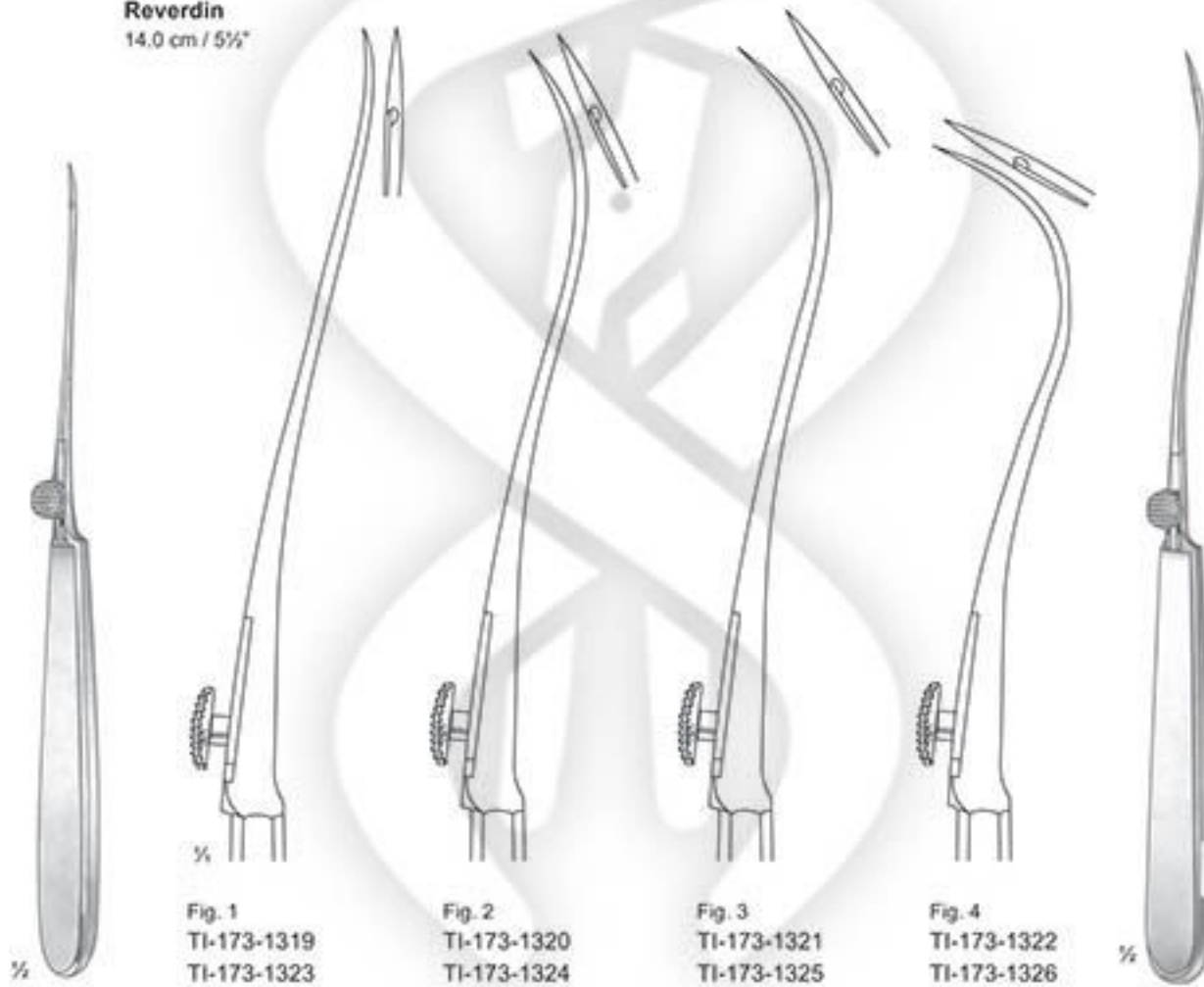

Reverdin
22.5 cm / 8 7/8"
TI-173-1319 - TI-173-1322

Reverdin
19.5 cm / 7 3/4"
TI-173-1323 - TI-173-1326

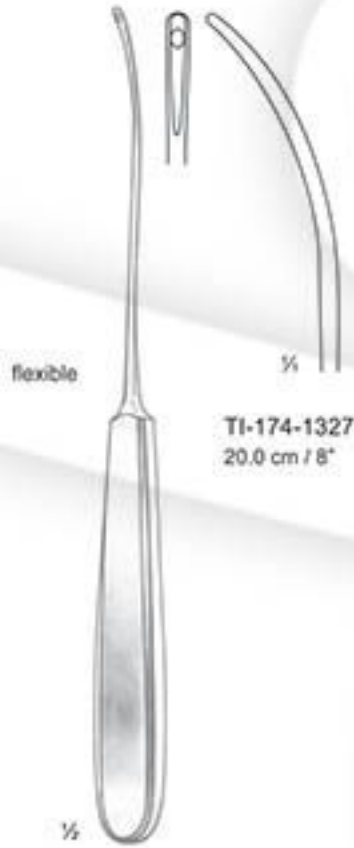

TC **GOLD**



$\frac{1}{2}$
Vascular
18.0 cm / 7"



TI-175-1333
with lock



TI-175-1334
with lock



TI-175-1335
without lock



TI-175-1336
without lock

Micro profile



$\frac{1}{2}$
Dietrich



TI-175-1337
16.0 cm / 6 $\frac{1}{4}$ "



TI-175-1338
18.0 cm / 7"



TI-175-1339
20.0 cm / 8"



TI-175-1340
23.0 cm / 9"



TI-175-1341
26.0 cm / 10 $\frac{1}{4}$ "

Micro profile

TC GOLD

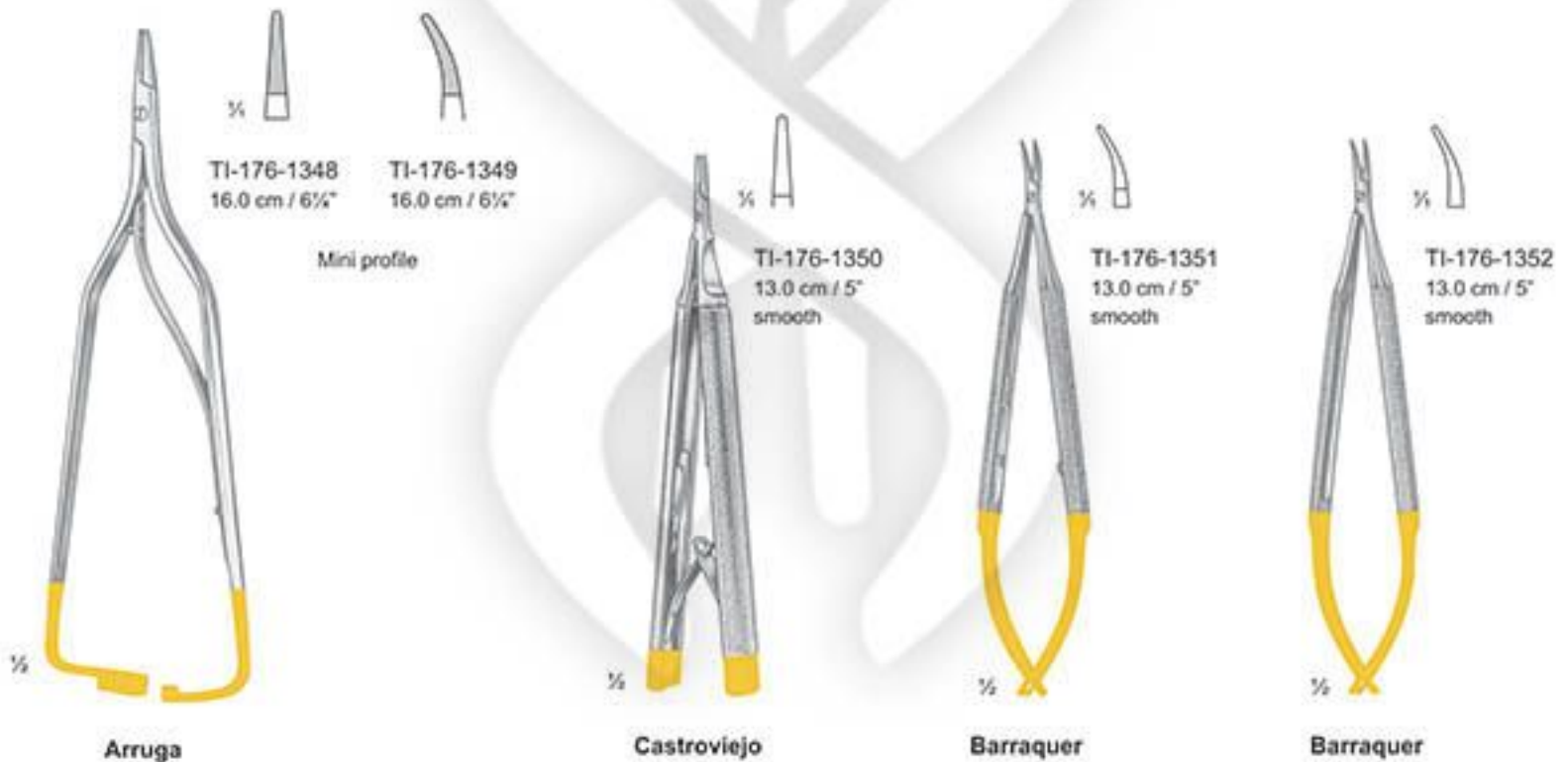
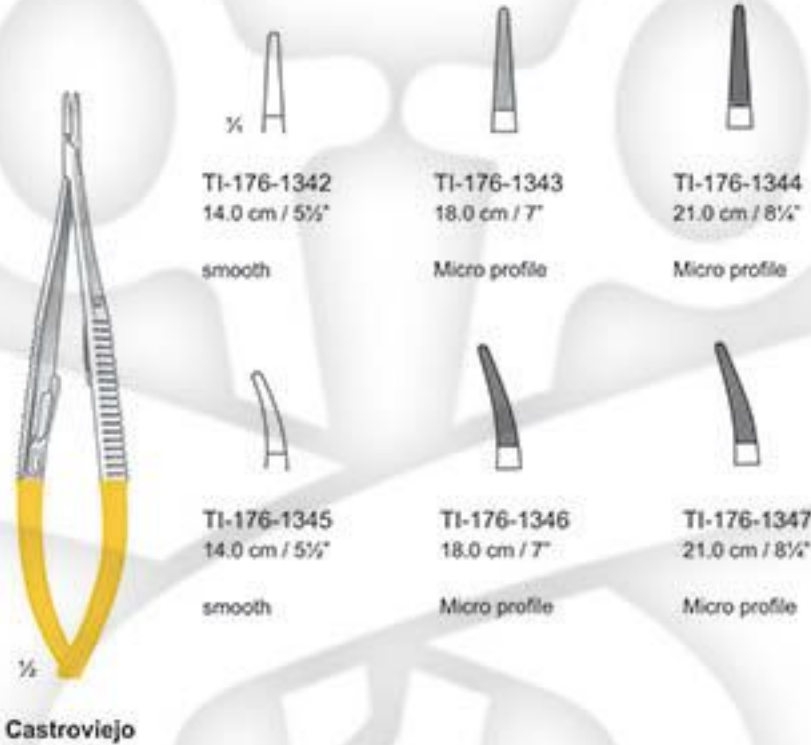

TC GOLD

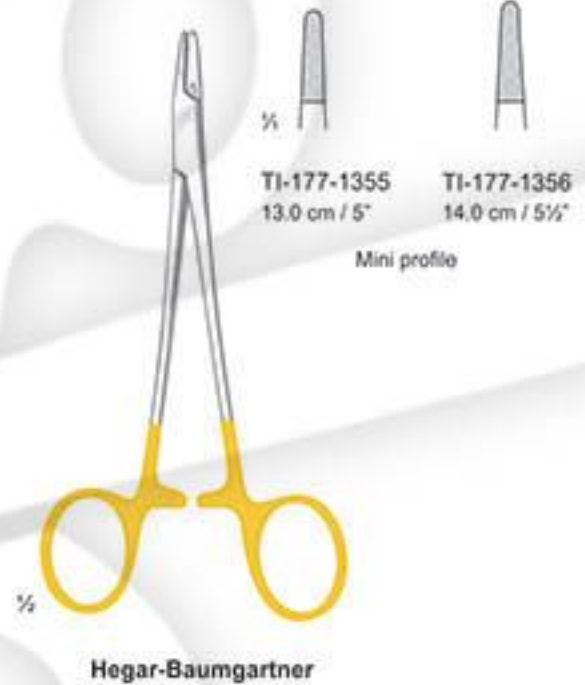

TC GOLD

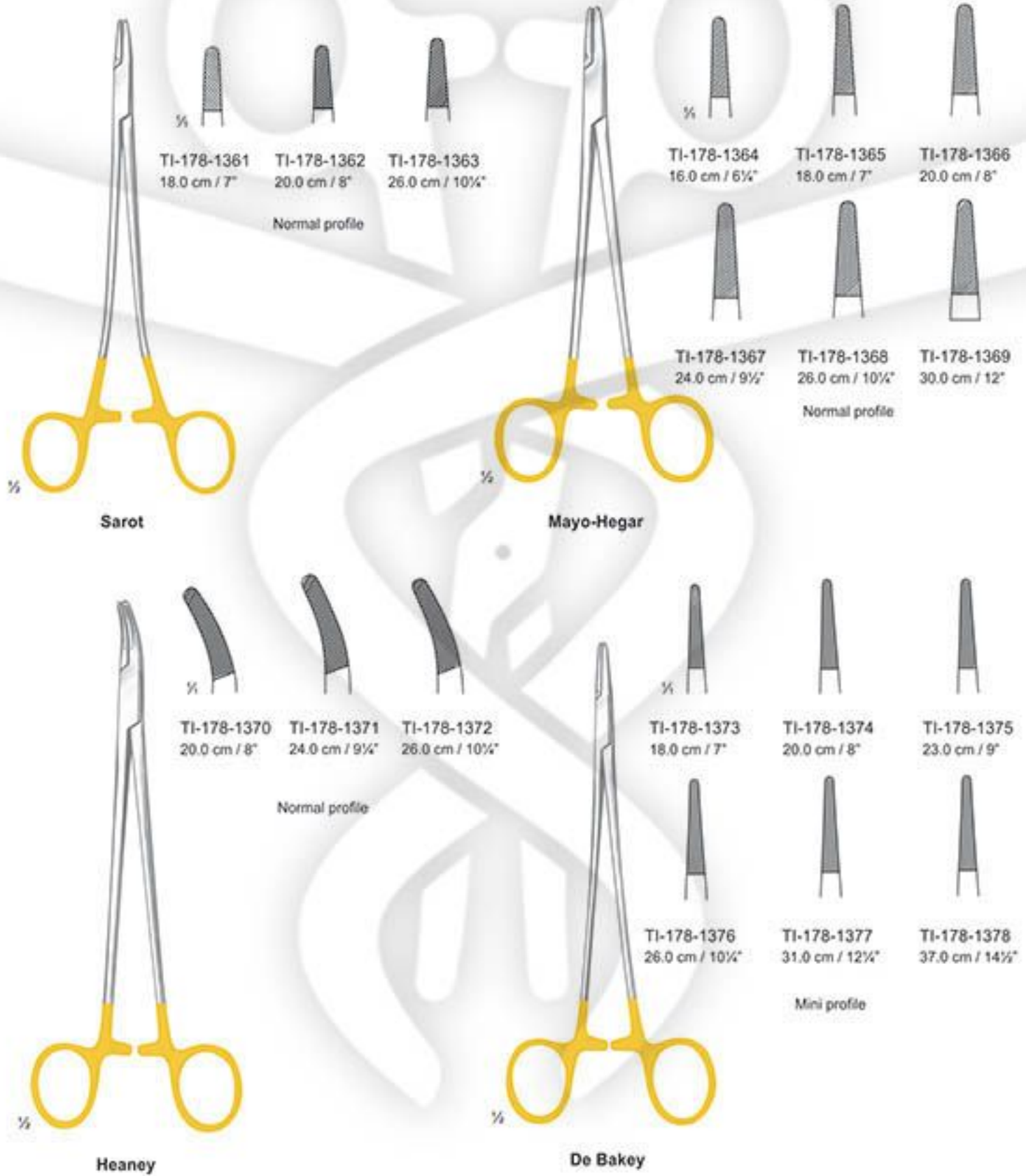

Instrument	Insert Profile	Part Number	Length (cm / inches)
Sarot	Normal profile	TI-178-1361	18.0 cm / 7"
		TI-178-1362	20.0 cm / 8"
		TI-178-1363	26.0 cm / 10 1/4"
	Normal profile	TI-178-1364	16.0 cm / 6 1/4"
		TI-178-1365	18.0 cm / 7"
		TI-178-1366	20.0 cm / 8"
Mayo-Hegar	Normal profile	TI-178-1367	24.0 cm / 9 1/2"
		TI-178-1368	26.0 cm / 10 1/4"
		TI-178-1369	30.0 cm / 12"
	Mini profile	TI-178-1370	20.0 cm / 8"
		TI-178-1371	24.0 cm / 9 1/4"
		TI-178-1372	26.0 cm / 10 1/4"
Heaney	Normal profile	TI-178-1373	18.0 cm / 7"
		TI-178-1374	20.0 cm / 8"
		TI-178-1375	23.0 cm / 9"
	Mini profile	TI-178-1376	26.0 cm / 10 1/4"
		TI-178-1377	31.0 cm / 12 1/4"
		TI-178-1378	37.0 cm / 14 1/2"
De Bakey	Normal profile	TI-178-1373	18.0 cm / 7"
		TI-178-1374	20.0 cm / 8"
		TI-178-1375	23.0 cm / 9"
	Mini profile	TI-178-1376	26.0 cm / 10 1/4"
		TI-178-1377	31.0 cm / 12 1/4"
		TI-178-1378	37.0 cm / 14 1/2"

TC / GOLD

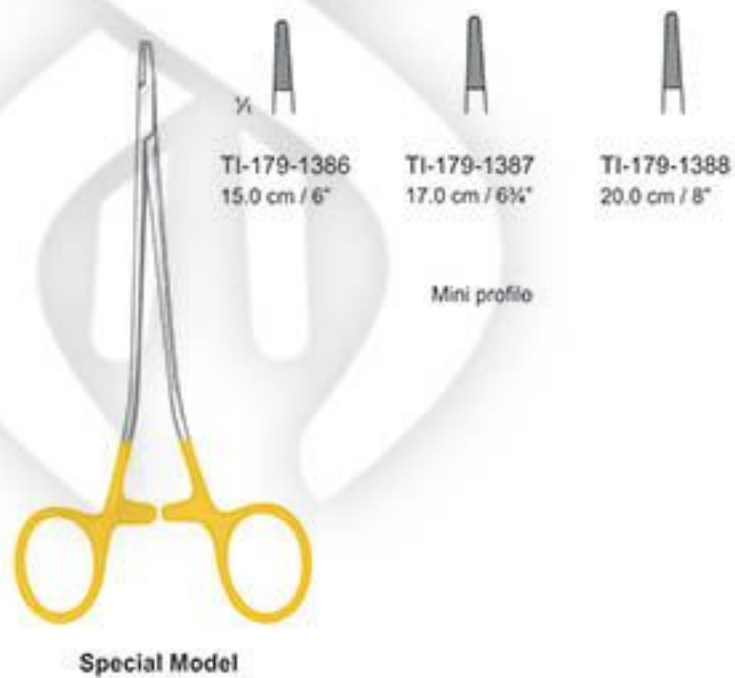

TC **GOLD**



TI-180-1389
27.0 cm / 10 1/2"
Normal profile

Finocchietto

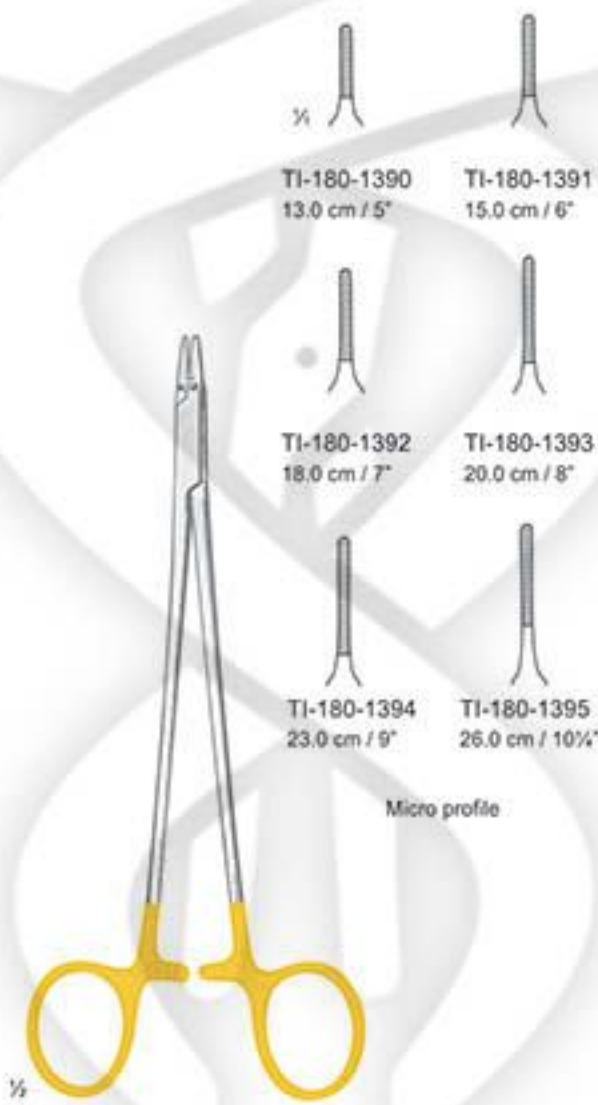

TI-180-1390
13.0 cm / 5"

TI-180-1391
15.0 cm / 6"

TI-180-1392
18.0 cm / 7"

TI-180-1393
20.0 cm / 8"

TI-180-1394
23.0 cm / 9"

TI-180-1395
26.0 cm / 10 1/4"

Micro profile

Ryder-Vascular



TI-180-1396
27.0 cm / 10 1/2"
Normal profile

Wangenstein

TC / GOLD

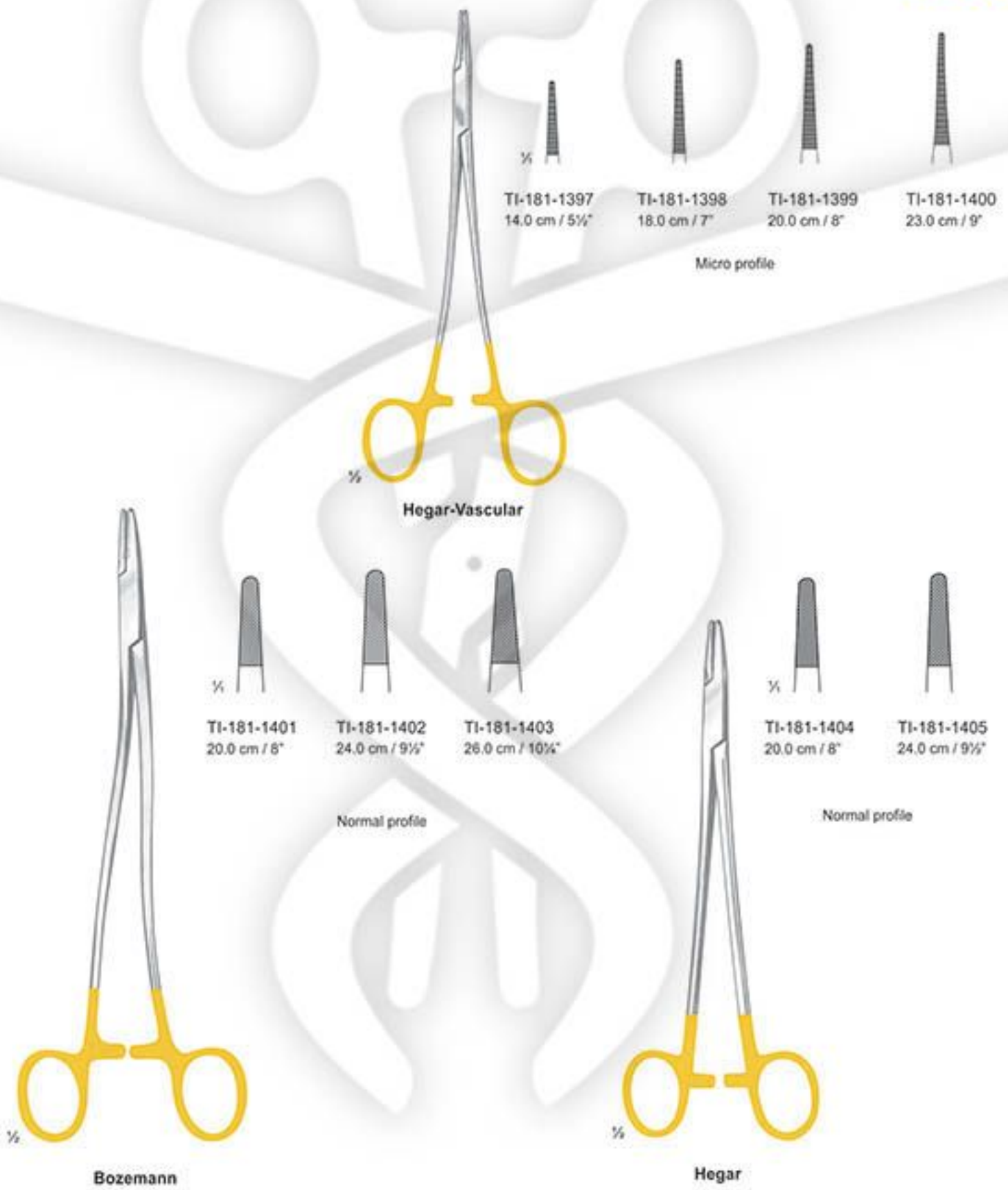

Model	Length (cm)	Length (in)	Profile
TI-181-1397	14.0	5½"	Micro profile
TI-181-1398	18.0	7"	Micro profile
TI-181-1399	20.0	8"	Micro profile
TI-181-1400	23.0	9"	Micro profile
TI-181-1401	20.0	8"	Normal profile
TI-181-1402	24.0	9½"	Normal profile
TI-181-1403	26.0	10¼"	Normal profile
TI-181-1404	20.0	8"	Normal profile
TI-181-1405	24.0	9½"	Normal profile

Hegar-Vascular

Bozemann

Hegar

TC **GOLD**



TI-182-1406
22.0 cm / 8 1/2"

TI-182-1407
23.0 cm / 9"

Normal profile



Stratte



TI-182-1408
14.5 cm / 5 1/2"

TI-182-1409
16.5 cm / 6 1/2"

TI-182-1410
18.0 cm / 7"

Normal profile



Olsen-Hegar



Gillies



TI-182-1411
16.0 cm / 6 1/4"
Normal profile



TC / GOLD



Mathieu-Kocher

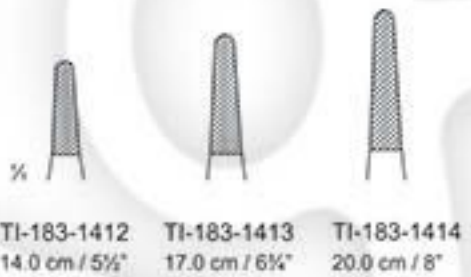

Normal profile



Mathieu



Normal profile



Mathieu

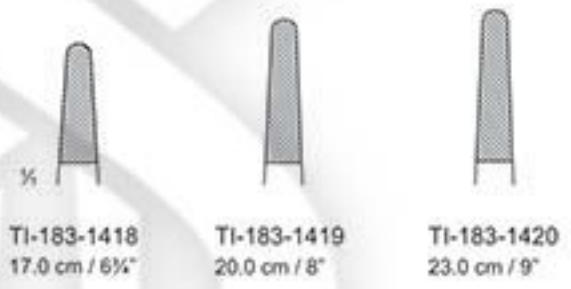

Normal profile

TC GOLD

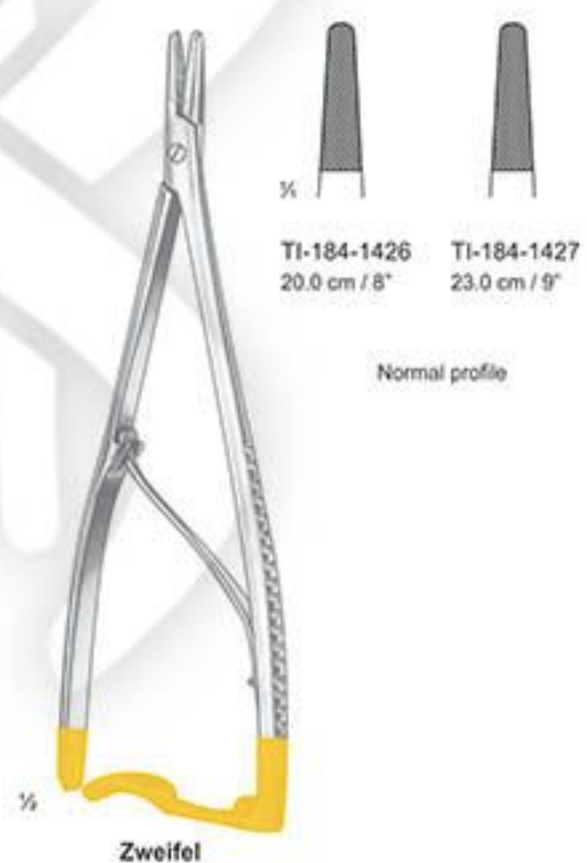
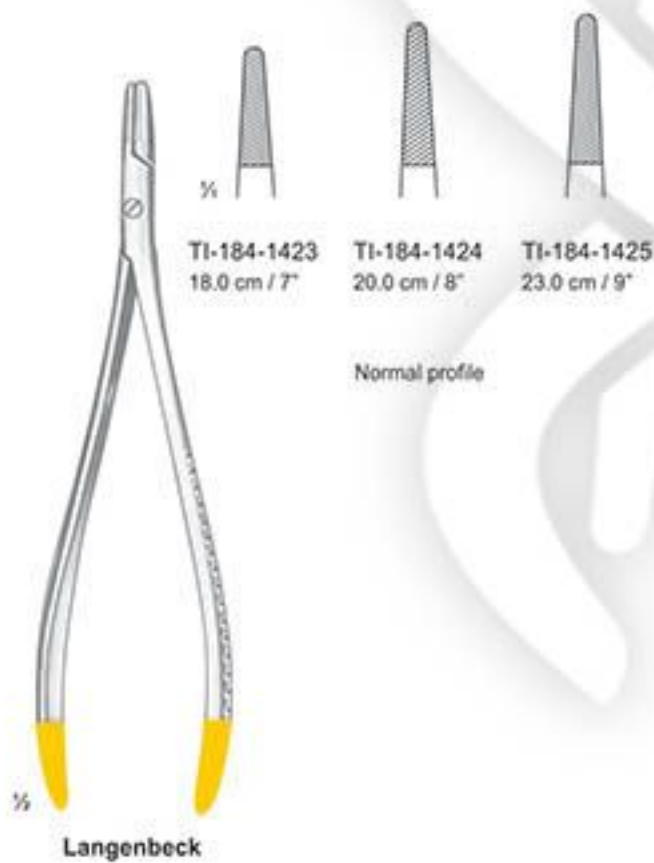

05

DRESSING INSTRUMENTS



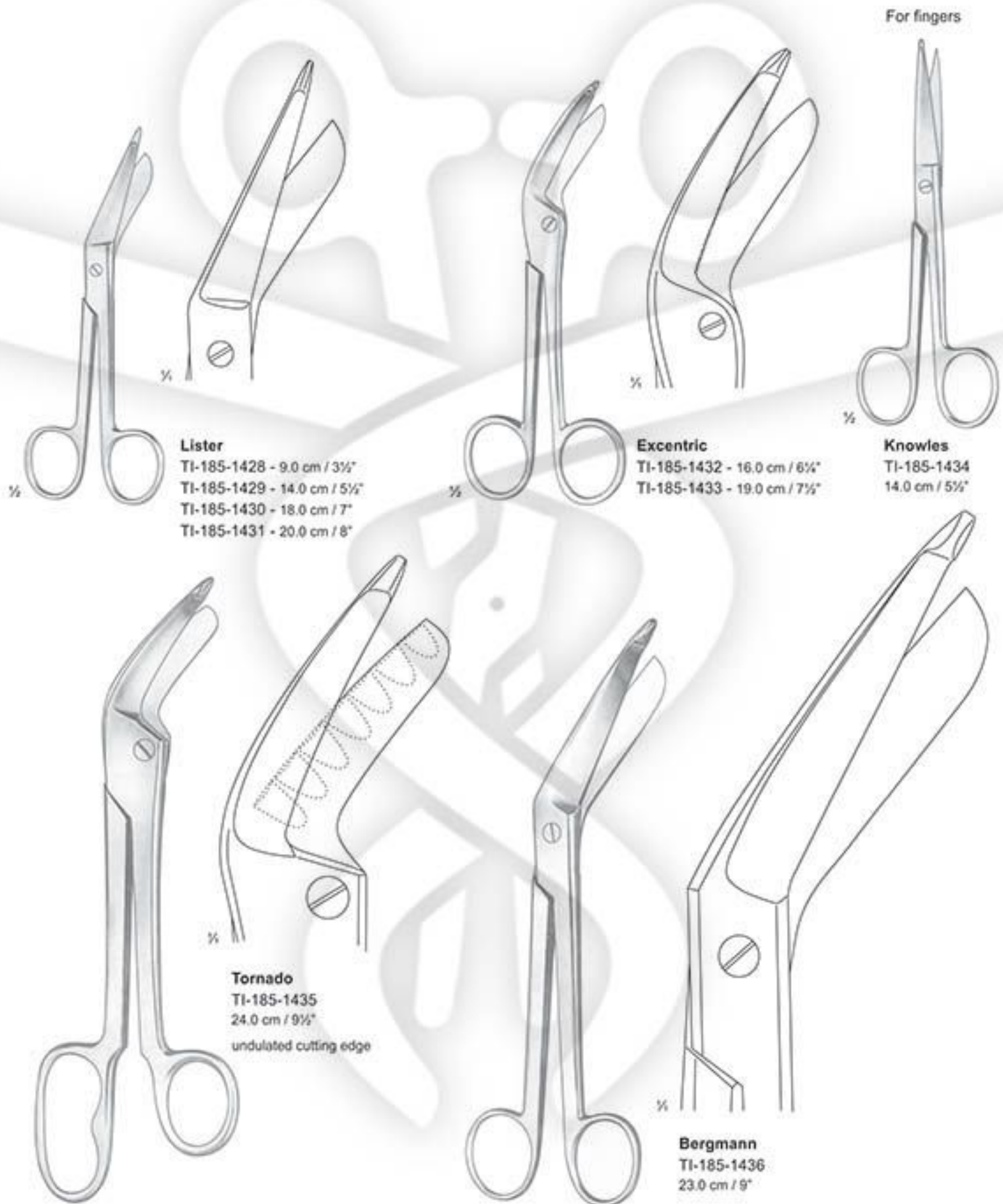



Esmarch
TI-186-1437 - 20.0 cm / 8"
TI-186-1438 - 22.0 cm / 8½"



Lister
TI-186-1439 - 15.0 cm / 6"
TI-186-1440 - 17.0 cm / 7"



TI-186-1441
20.0 cm / 8"

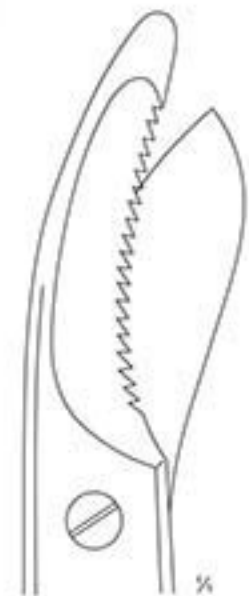

Bruns
TI-186-1442
24.0 cm / 9½"

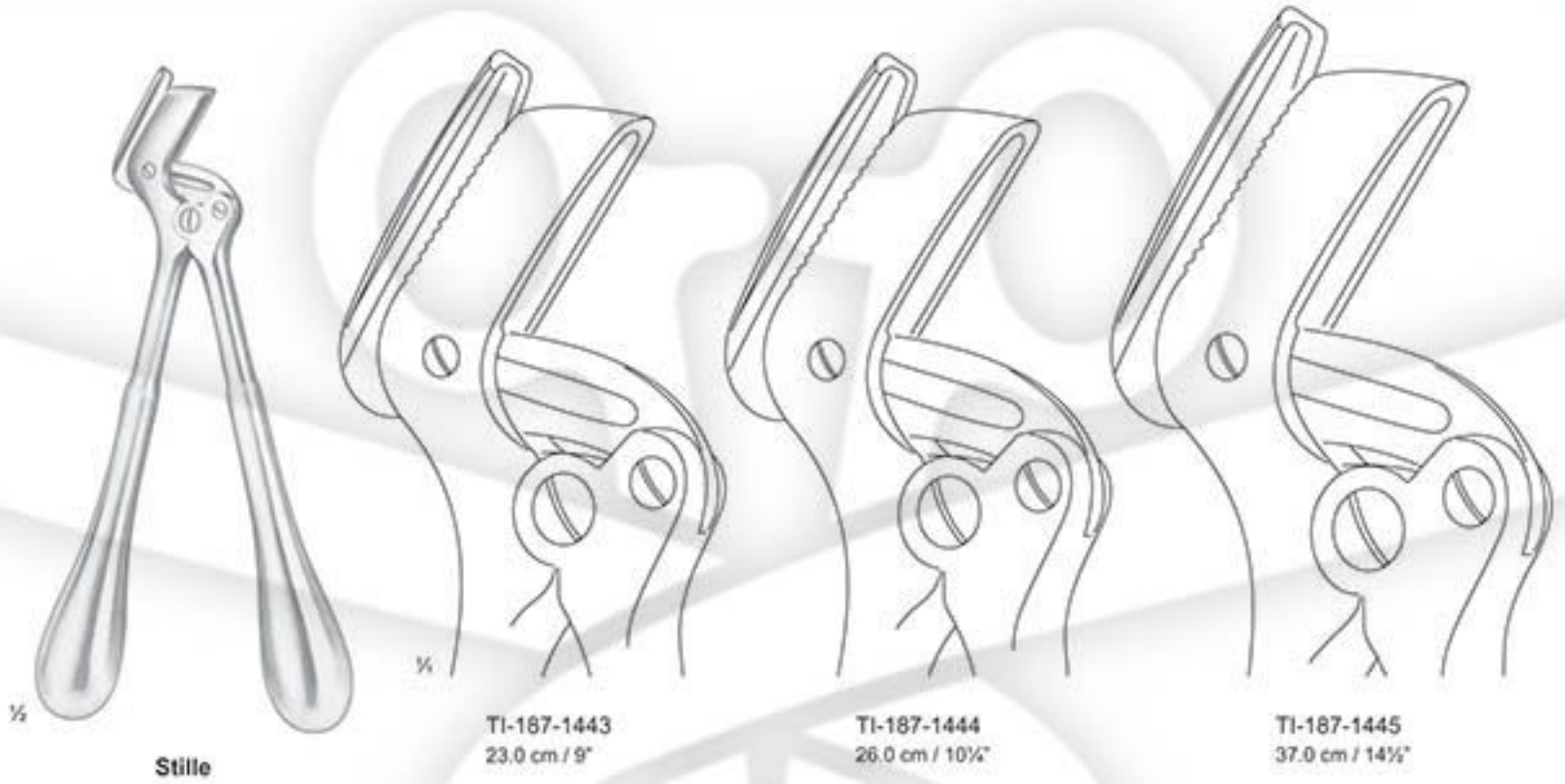



Engel
TI-188-1448
14.0 cm / 5½"



Hopkins
TI-188-1449
20.0 cm / 8"



Esmarch
TI-188-1450
18.0 cm / 7"



Reiner
TI-188-1451
18.5 cm / 7¼"



Special Mod. Britton
TI-188-1452
21.0 cm / 8¼"



Henning



1/2

TI-189-1453
28.0 cm / 11"

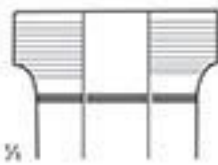

1/2



1/2

TI-189-1454
23.0 cm / 9"



Wolff



1/2

TI-189-1455
18.0 cm / 7"



TI-189-1456
24.0 cm / 9 1/2"

06

ORTHOPEDIC INSTRUMENTS



TALC INDUSTRIES
ONE STOP FOR MEDICAL EQUIPMENT



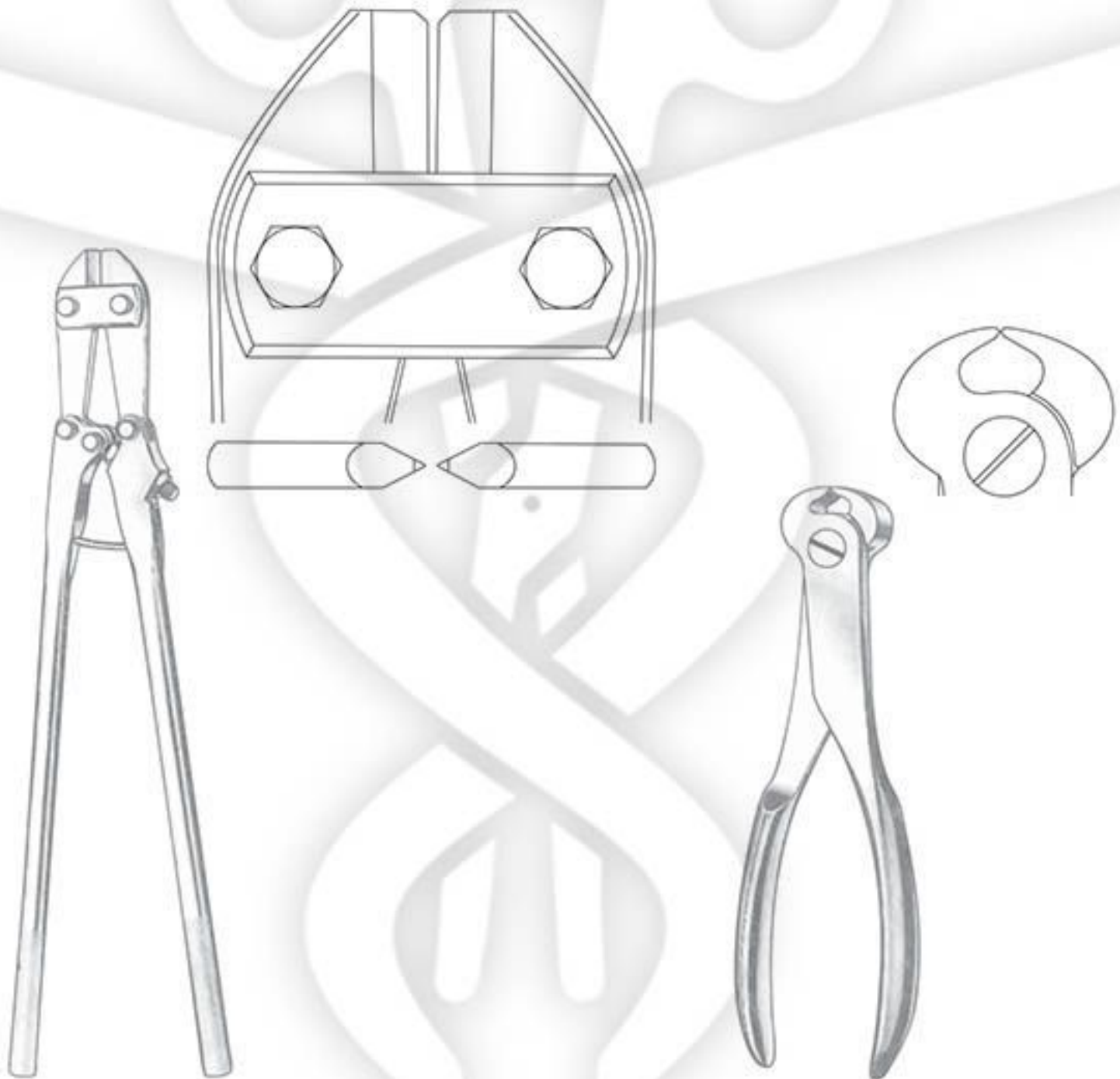

Large Pin Cutter
TI-190-1457
55.6 cm / 22
cut rods up to .250" (6.3mm).
toggle joint transfers leverage to the cutting blades

Cannulated Pin Cutter
TI-190-1458
19.0 cm / 7½", end cutting
maximum .062" (1.6mm)



Needle Nose Pliers
TI-191-1459
14.0 cm / 5½", grooved jaws,
tips taper to 1mm



Parallel Pliers
TI-191-1460
18.0 cm / 7", grooved 10 mm wide jaws
for pin removal



Slip Joint Adjustable Pliers
TI-191-1461
19.7 cm / 7¾"

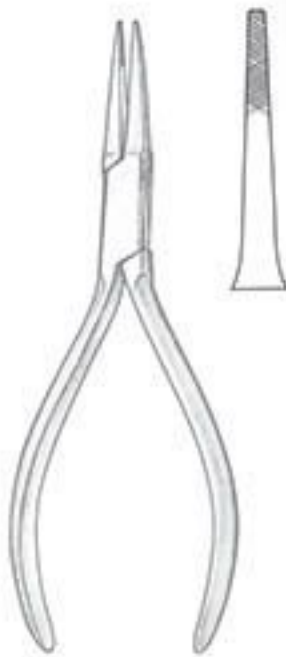

Flat Nose Pliers
Ti-192-1462
15.0 cm / 6", tips taper to 2mm

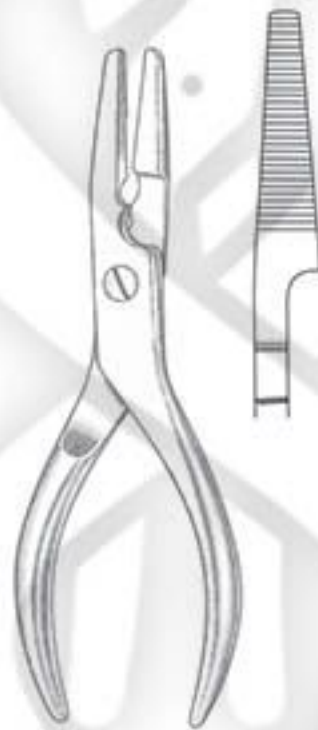

Flat Nose Pliers
Ti-192-1463
16.5 cm / 6½", side cutting blades
tips taper to 3.5 mm

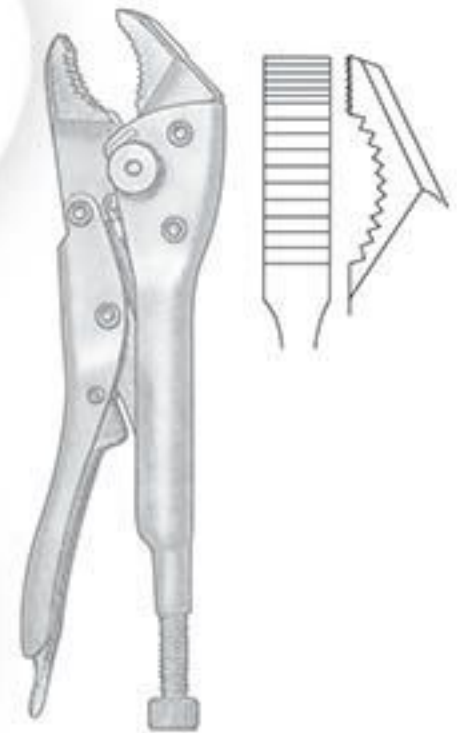

Heavy Duty Locking Pliers
Ti-192-1464
17.0 cm / 6¾" 7mm wide tip
reinforced jaw hinge, self-locking lever with
adjustment screw and one-handed quick release



Heavy Duty Locking Pliers

TI-193-1465

20.0 cm / 8" 9mm wide tip
reinforced jaw hinge,
self-locking lever with adjustment
screw and one-handed quick release

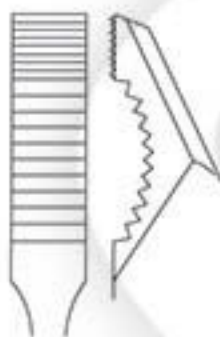

Heavy Duty Locking Pliers

TI-193-1466

24.0 cm / 9½" 5mm wide tip
reinforced jaw hinge,
self-locking lever with
adjustment screw and
one-handed quick release



Townley Femur Caliper

TI-193-1467

11.5 cm / 4½"

07

BONE SURGERY INSTRUMENTS



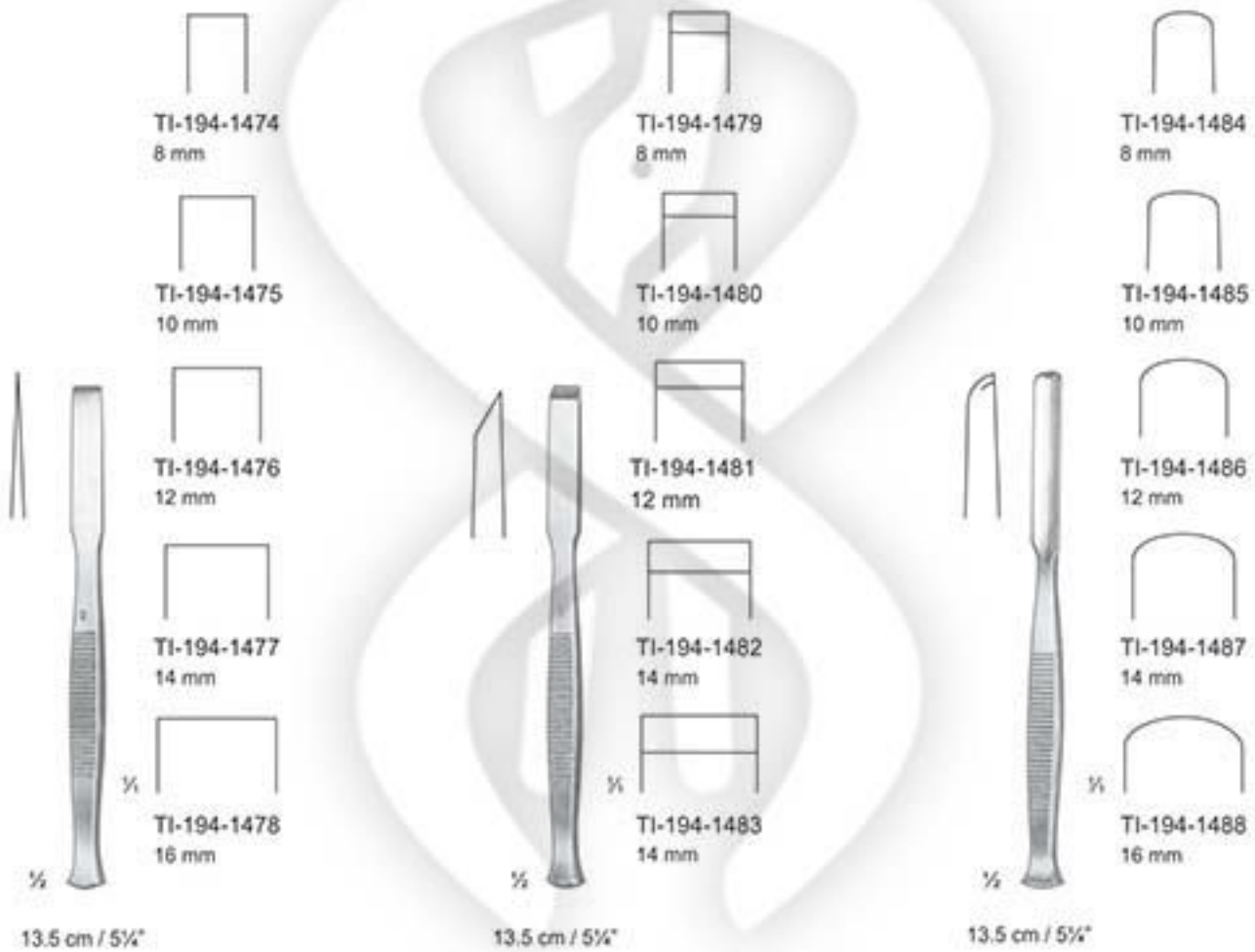
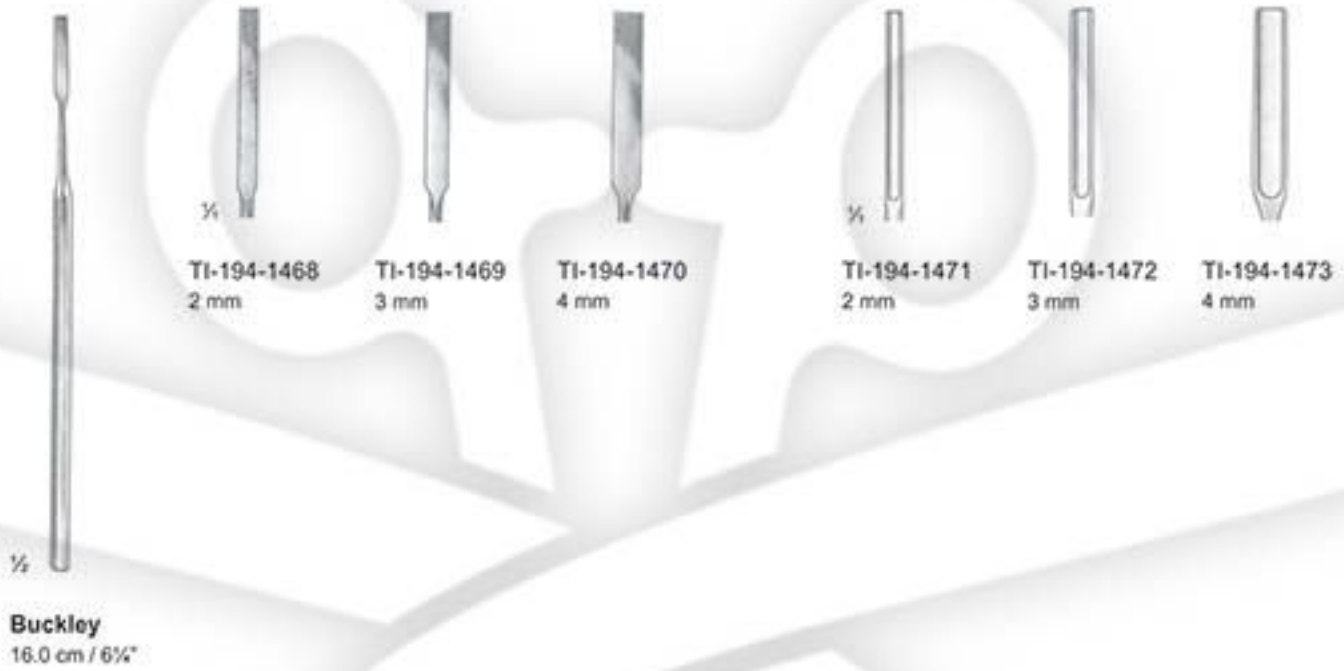



Buck-Gramcko
TI-195-1489
11.0 cm / 4 1/4"



TI-195-1490
11.0 cm / 4 1/4"



TI-195-1491
10.0 cm / 4"



TI-195-1492
10.0 cm / 4"

13.5 cm / 5 1/4"

17.0 cm / 6 1/2"



TI-195-1493
2 mm



TI-195-1498
2 mm

13.5 cm / 5 1/4"

17.0 cm / 6 1/2"



TI-195-1503
2 mm



TI-195-1508
2 mm



TI-195-1513
4 mm



TI-195-1519
4 mm



TI-195-1494
3 mm



TI-195-1499
3 mm



TI-195-1504
3 mm



TI-195-1509
3 mm



TI-195-1514
6 mm



TI-195-1520
6 mm



TI-195-1495
4 mm



TI-195-1500
4 mm



TI-195-1505
4 mm



TI-195-1510
4 mm



TI-195-1515
8 mm



TI-195-1521
8 mm



TI-195-1496
5 mm



TI-195-1501
5 mm



TI-195-1506
5 mm



TI-195-1511
5 mm



TI-195-1516
10 mm



TI-195-1522
10 mm



TI-195-1497
6 mm



TI-195-1502
6 mm



TI-195-1507
6 mm



TI-195-1512
6 mm



TI-195-1517
12 mm



TI-195-1523
12 mm



TI-195-1498
6 mm



TI-195-1503
6 mm



TI-195-1508
6 mm



TI-195-1513
6 mm



TI-195-1518
14 mm



TI-195-1524
14 mm



Partsch



Alexander
18.0 cm / 7"



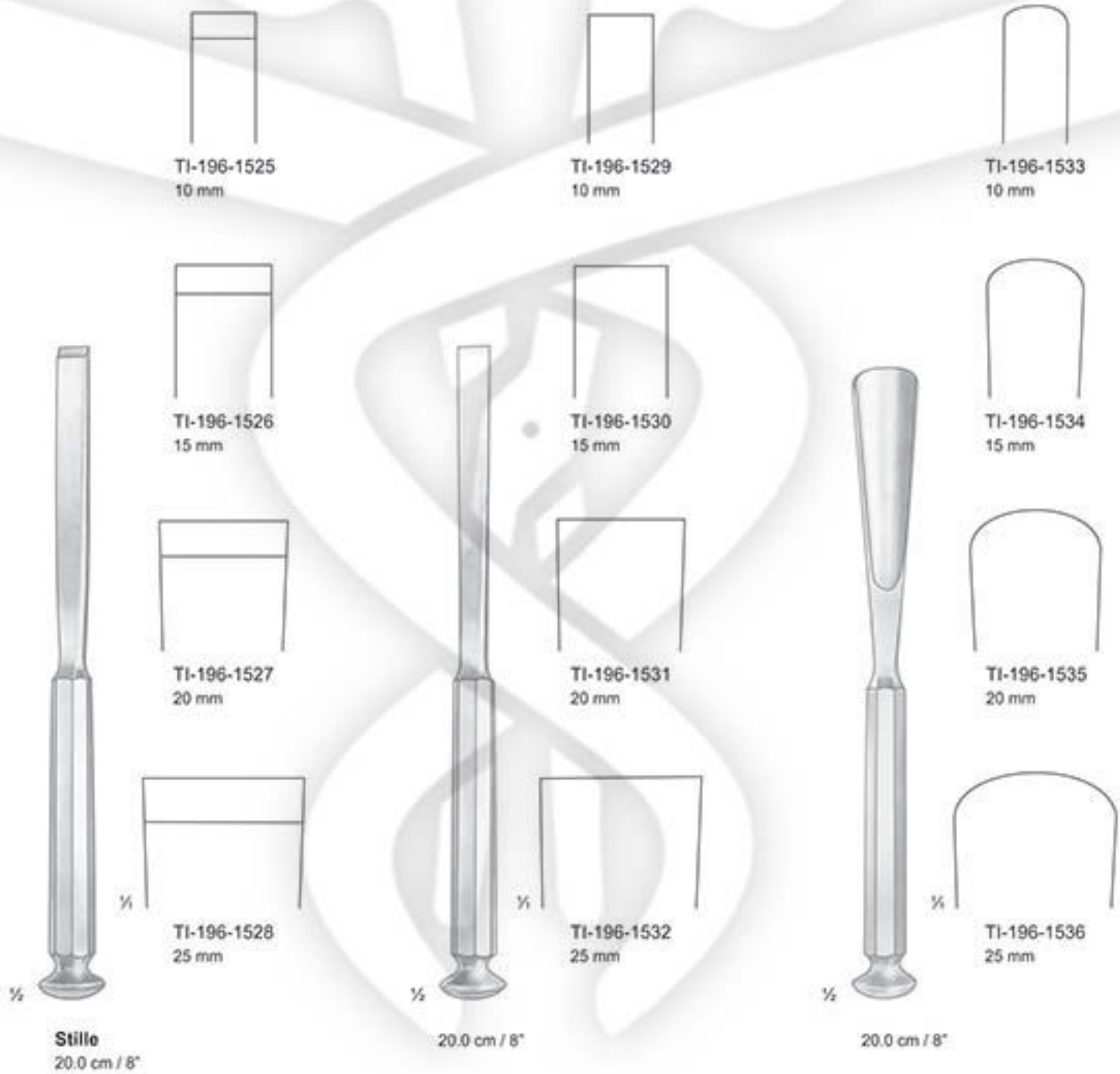

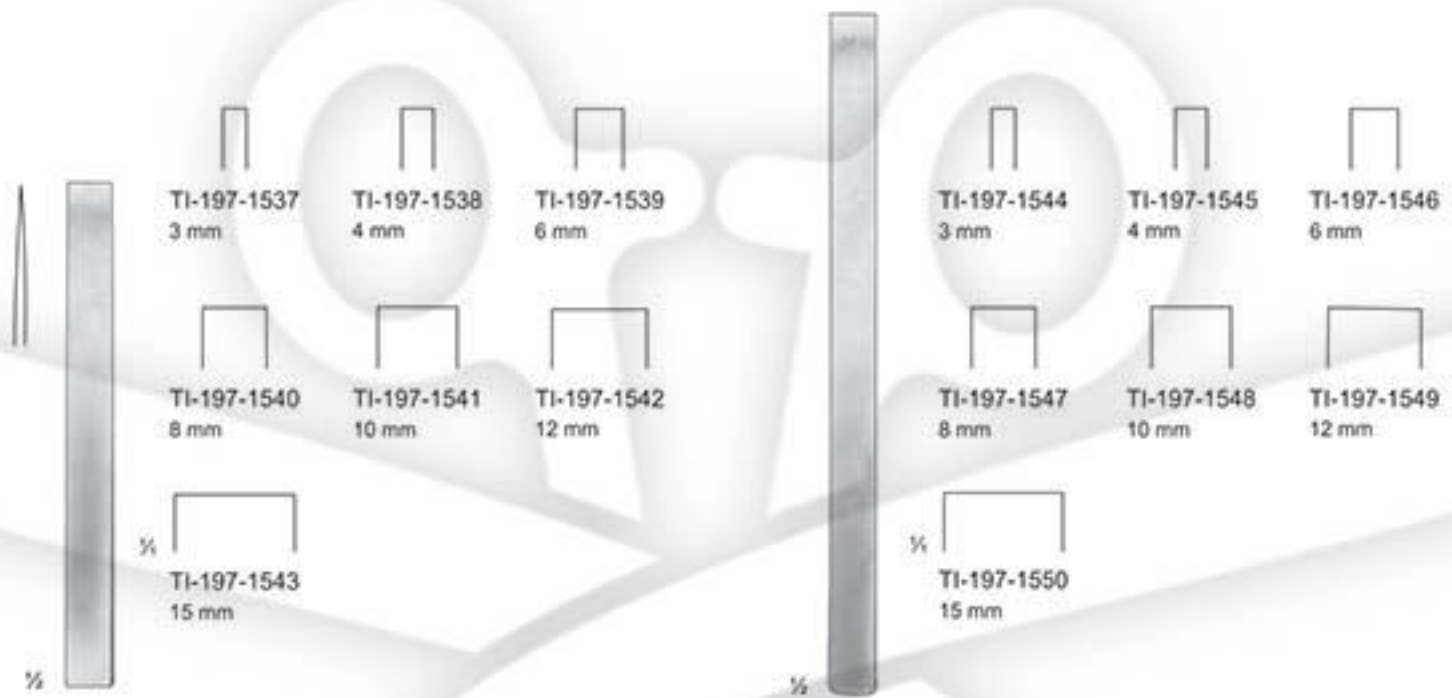

Mini-Lambotte
12.5 cm / 5"

Mini-Lambotte
17.0 cm / 6 1/2"

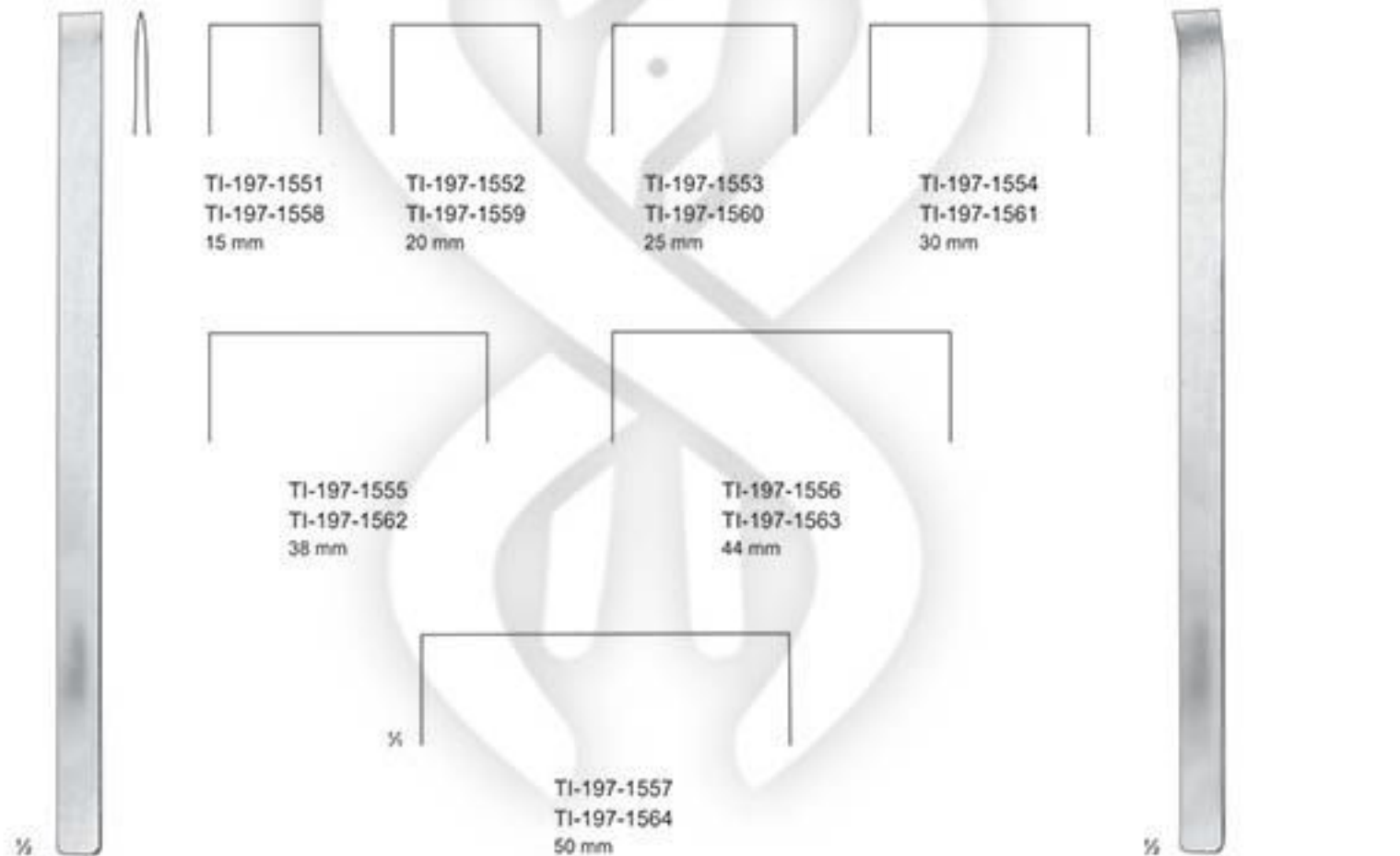

Lambotte
TI-197-1551 - TI-197-1557
24.0 cm / 9 1/2"

Lambotte
TI-197-1558 - TI-197-1564
23.0 cm / 9"

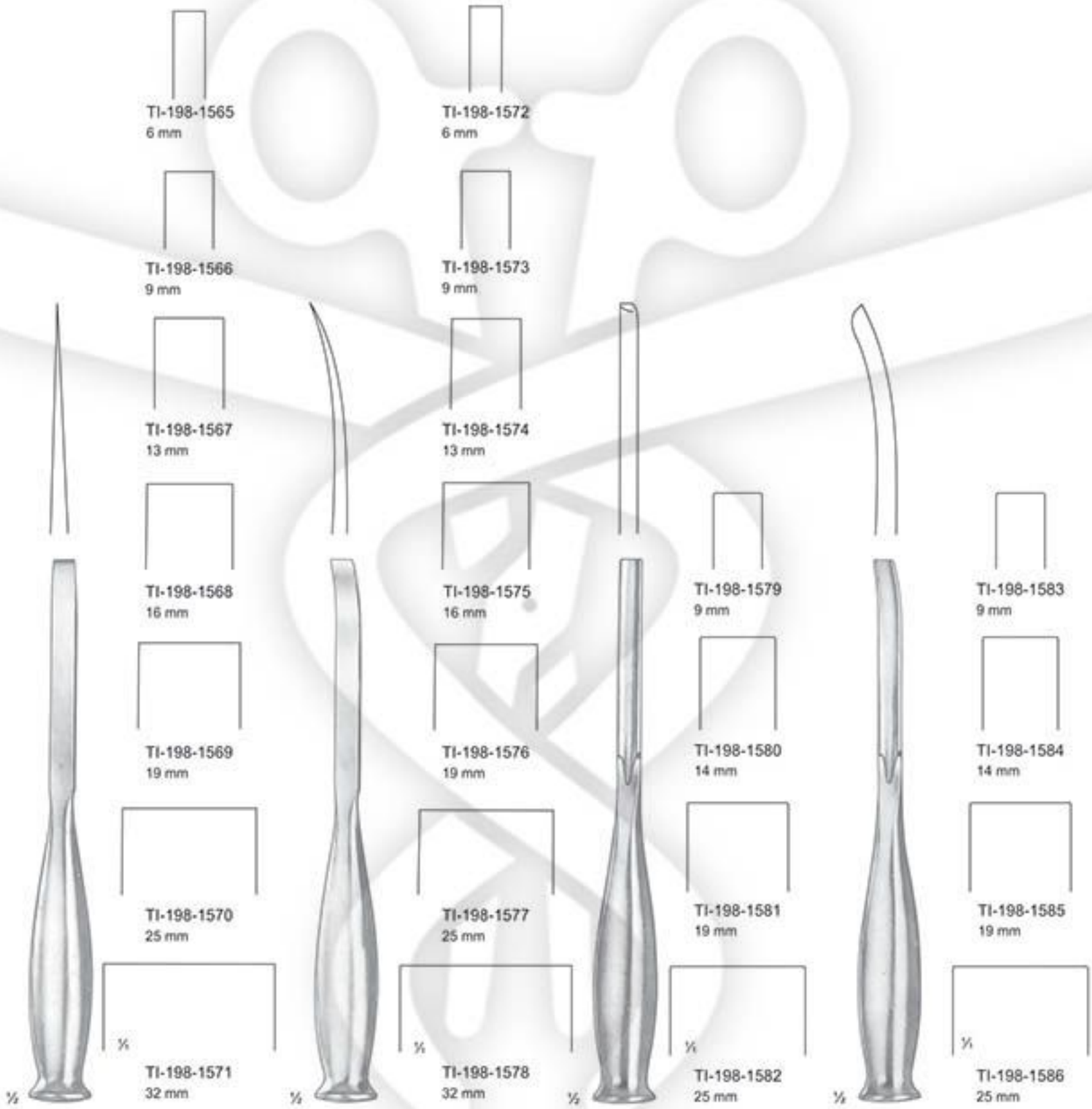

Smith-Petersen
20.0 cm / 8"

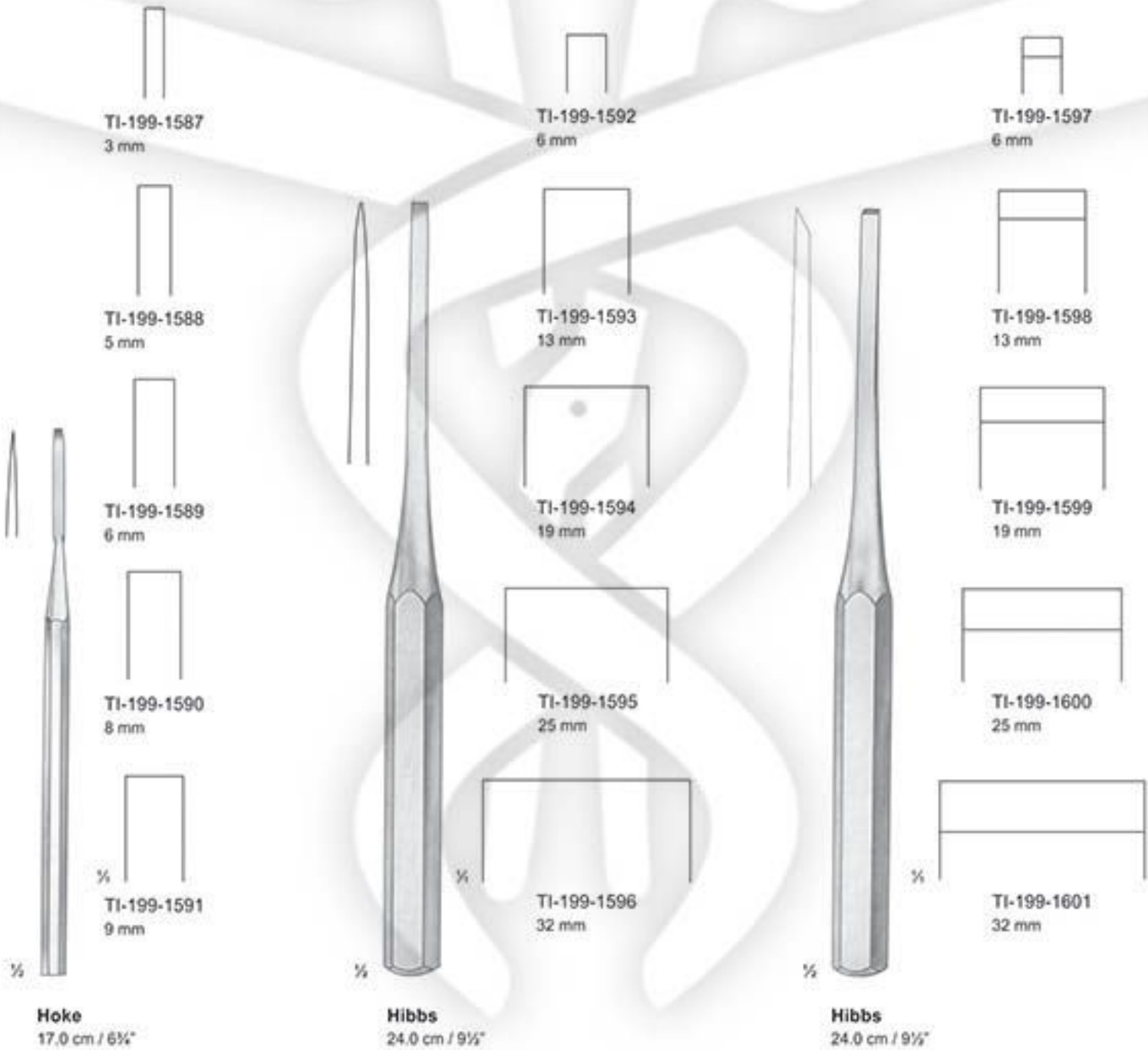

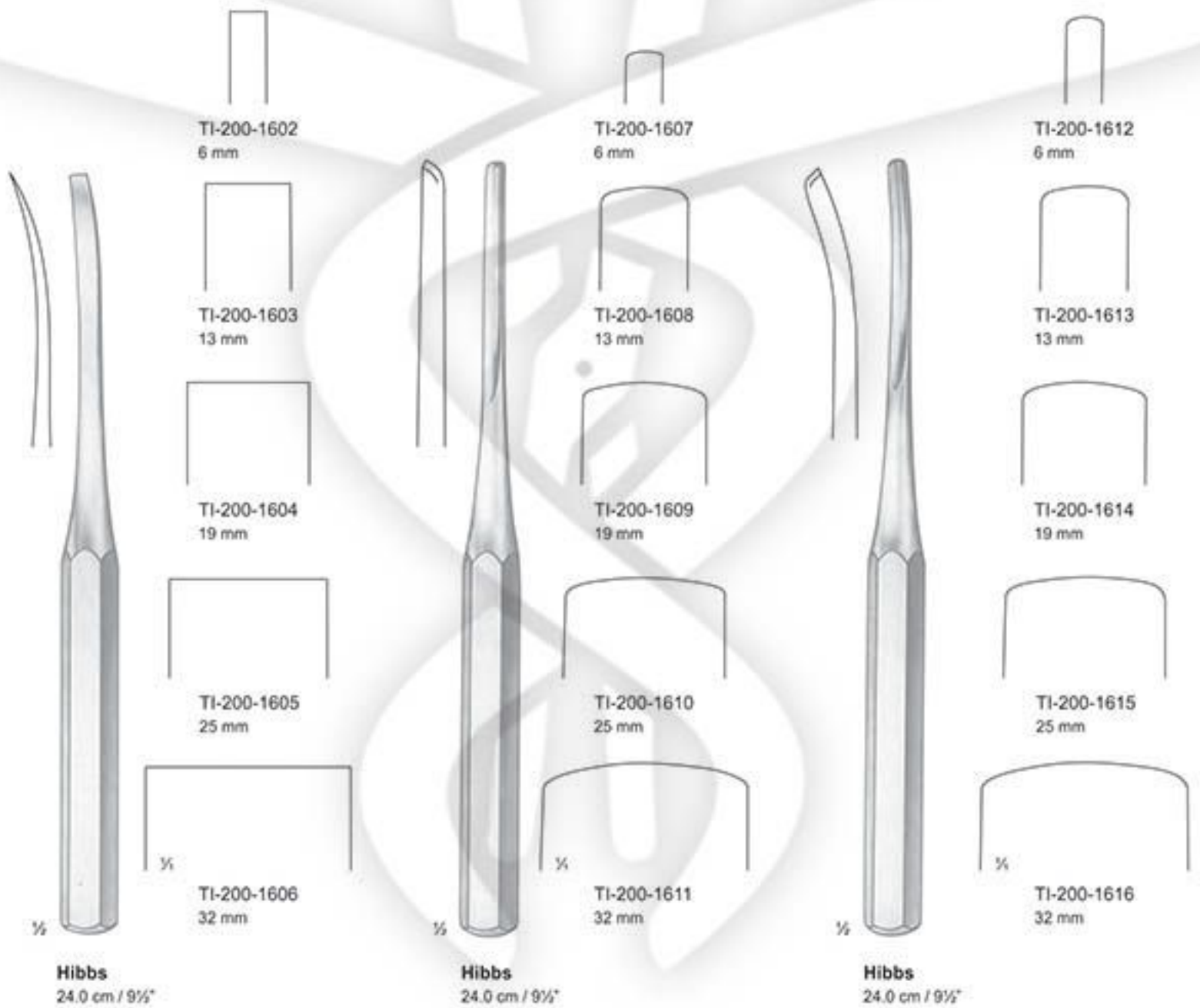

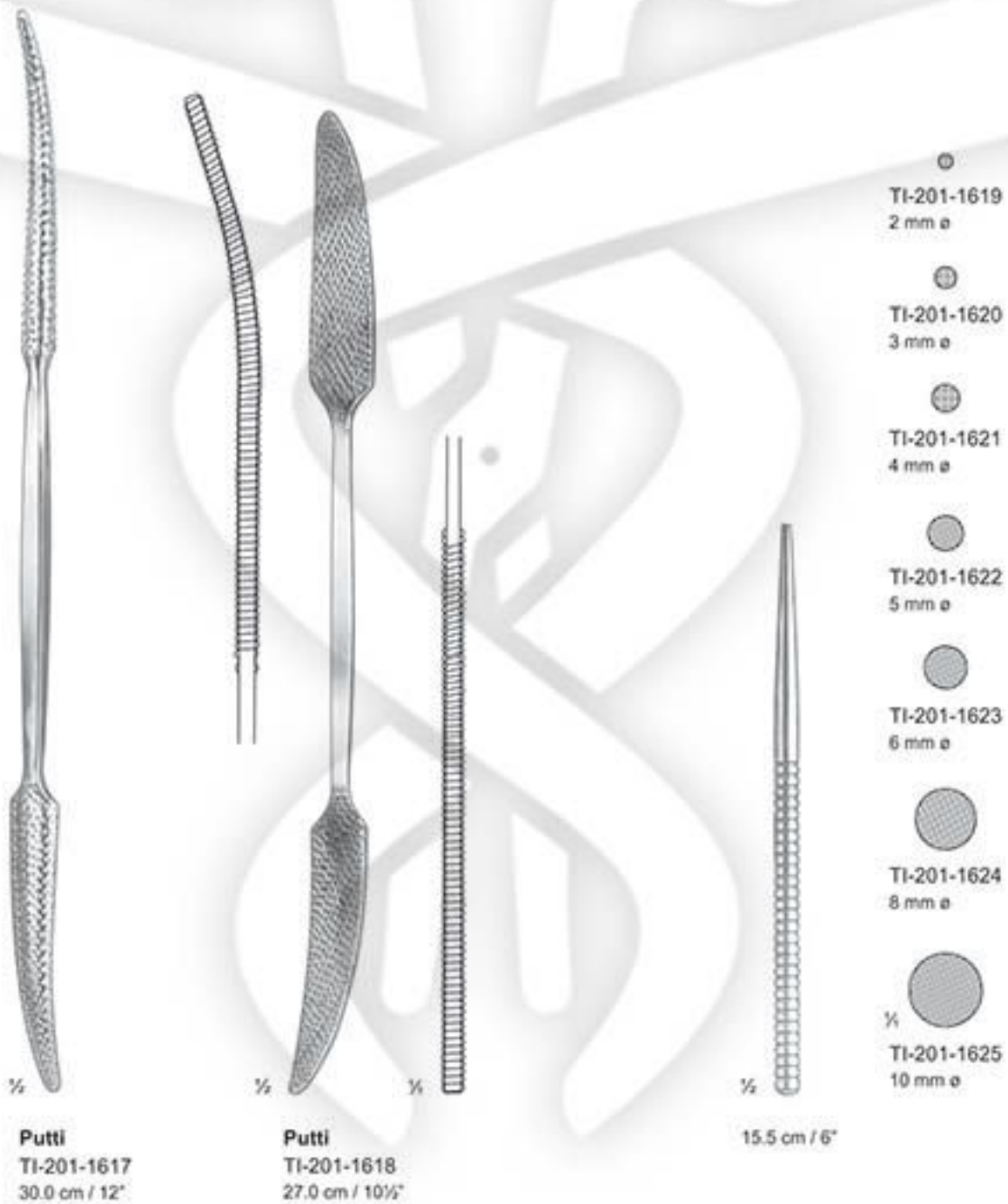



Williger
24.0 cm / 9½"

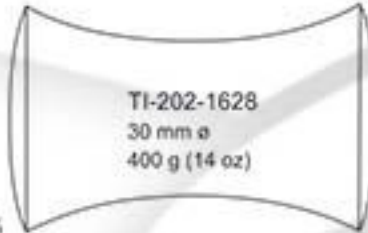
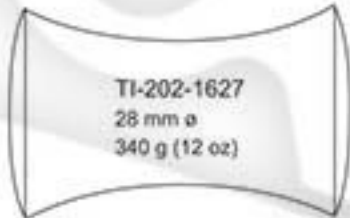
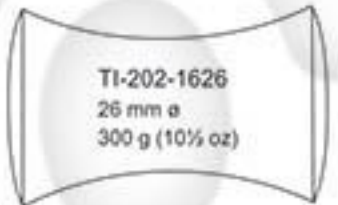

Doyen
21.0 cm / 8½"

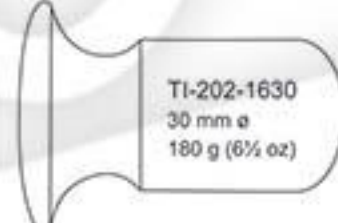
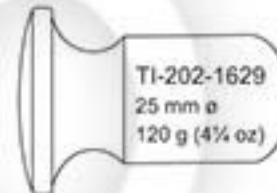

Collin
TI-202-1632
20.0 cm / 8"



Lucae
19.0 cm / 7½"

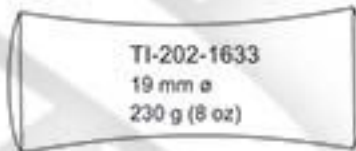

TI-202-1635
16.5 cm / 6½"

20 mm ø
140 g
(5 oz)

30 mm ø
510 g (18 oz)



TI-203-1636
26.5 cm / 10½"

with interchangeable
Ferrozell faces

26 mm ø
320 g (11¼ oz)



Mead
TI-203-1637
17.0 cm / 6¾"
Solid
Ferrozell faces only, pair

22 mm ø
200 g (7 oz)



Partsch
TI-203-1638
18.0 cm / 7"

45 mm ø
290 g (10 oz)



TI-203-1639
23.0 cm / 9"
hardwood, lead filled

80 x 60 mm ø
400 g



Steinbach
TI-204-1640
24.0 cm / 9½"
Ferozell, solid

42 mm ø
250 g
400 g



TI-204-1641
26.0 cm / 10¼"
Plastic, lead filled
TI-204-1642
26.0 cm / 10¼"

Ferozell, without lead

42 mm ø
250 g



TI-204-1643
26.0 cm / 10¼"
Ferozell, without lead



TI-204-1644
26.5 cm / 10½"
repercussion free



TI-205-1645
Spare faces, pair

42 mm ø
530 g (19 oz)

30 mm ø



1/4

TI-205-1646
26.5 cm / 10 1/2"

steel, solid,
with plastic handle

30 mm ø
480 g



1/4

TI-205-1647
24.0 cm / 9 1/2"

steel, solid,
with plastic handle

37 mm ø
370 g



1/4

TI-205-1648
22.5 cm / 9"

steel, solid,
with ferrozell faces

30 mm
125 g (4 oz)



1/4

TI-205-1649
22.5 cm / 9"

ferrozell solid



1/2

TI-206-1650
24.0 cm / 9 1/2"

steel, solid,
with plastic handle

1/2



















TI-206-1651
26.5 cm / 10 1/2"

steel, solid

1/2

TI-206-1652
26.5 cm / 10 1/2"

steel, solid

	 Fig. 0000 TI-207-1653	 Fig. 2 TI-207-1658		 Fig. 0 TI-207-1663
	 Fig. 000 TI-207-1654	 Fig. 3 TI-207-1659		 Fig. 1 TI-207-1664
	 Fig. 00 TI-207-1655	 Fig. 4 TI-207-1660		 Fig. 2 TI-207-1665
	 Fig. 0 TI-207-1656	 Fig. 5 TI-207-1661		 Fig. 3 TI-207-1666
	 Fig. 1 TI-207-1657	 Fig. 6 TI-207-1662		 Fig. 4 TI-207-1667
				
<p>Volkman 17.0 cm / 6 3/4"</p> <p>Handle from artificial wood</p>				<p>Volkman 27.0 cm / 10 1/2"</p> <p>Handle from artificial wood</p>

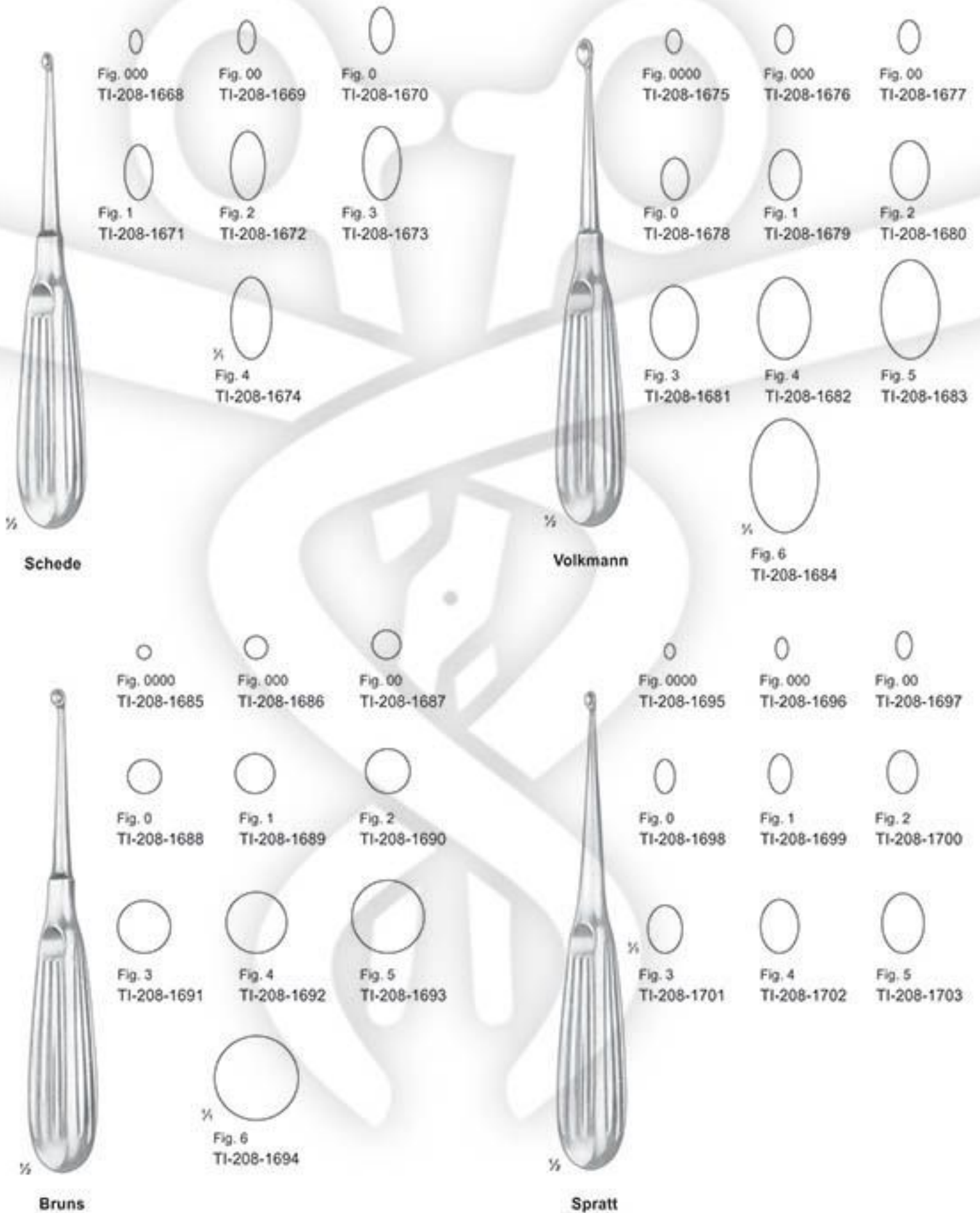

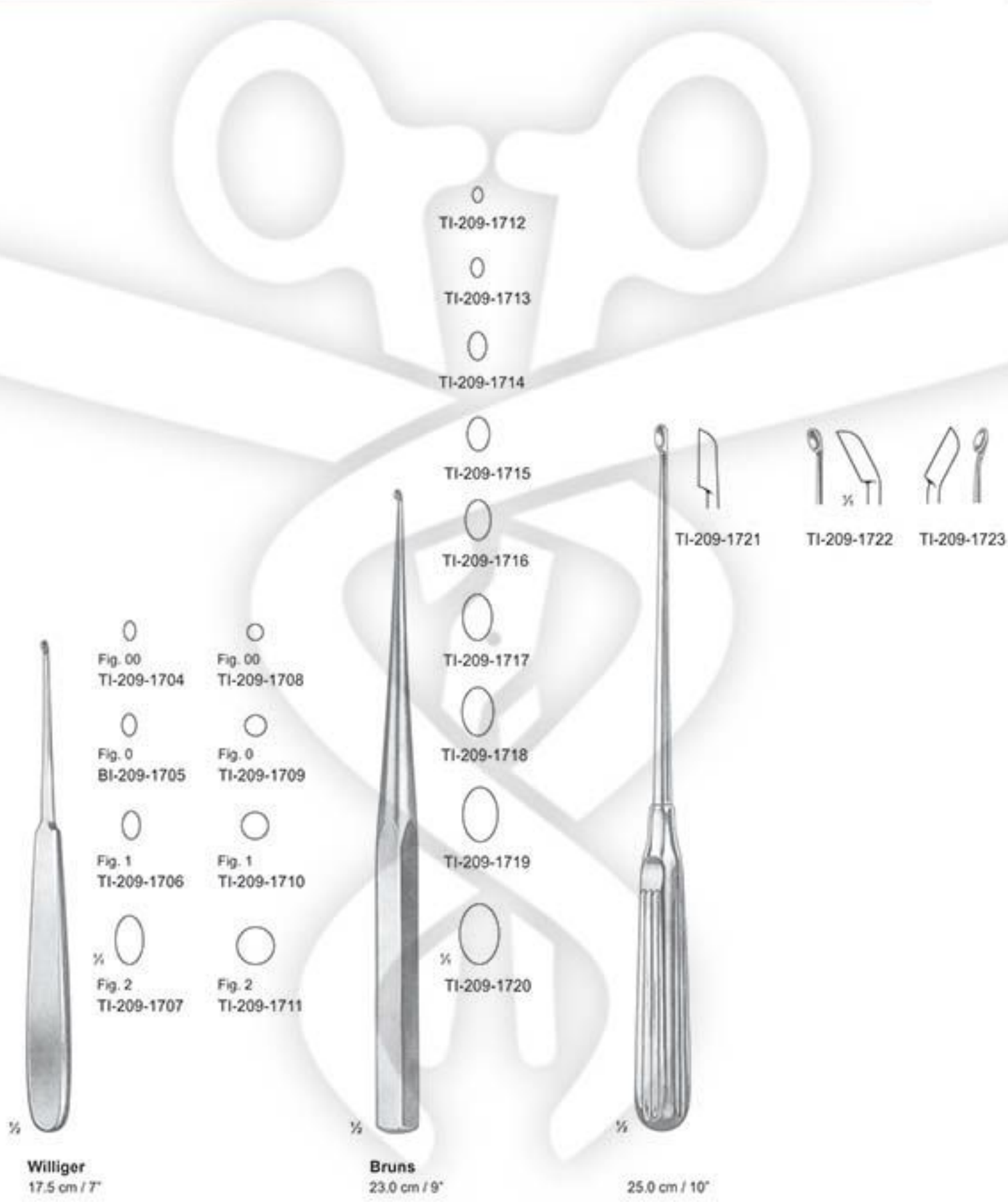

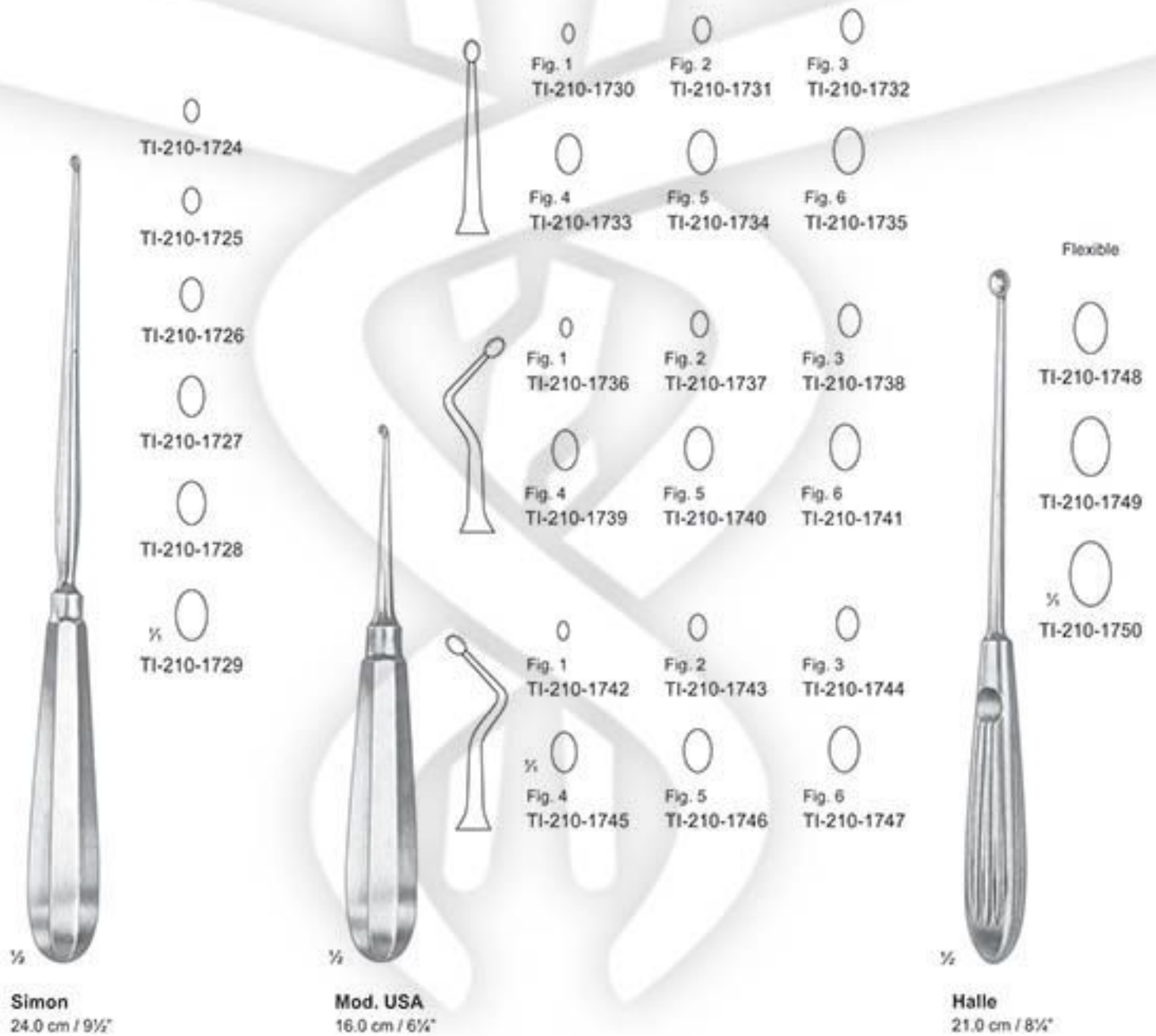

Model	Length	Diagram	Part Number
Simon 24.0 cm / 9½"	½	○	TI-210-1724
		○	TI-210-1725
		○	TI-210-1726
		○	TI-210-1727
		○	TI-210-1728
		½	TI-210-1729
Mod. USA 16.0 cm / 6¼"	½	○	TI-210-1730
		○	TI-210-1731
		○	TI-210-1732
		○	TI-210-1733
		○	TI-210-1734
		○	TI-210-1735
Halle 21.0 cm / 8¼"	½	○	TI-210-1736
		○	TI-210-1737
		○	TI-210-1738
		○	TI-210-1739
		○	TI-210-1740
		○	TI-210-1741
Flexible	½	○	TI-210-1742
		○	TI-210-1743
		○	TI-210-1744
		○	TI-210-1745
		○	TI-210-1746
		○	TI-210-1747
Flexible	○	○	TI-210-1748
		○	TI-210-1749
		½	TI-210-1750



Volkman

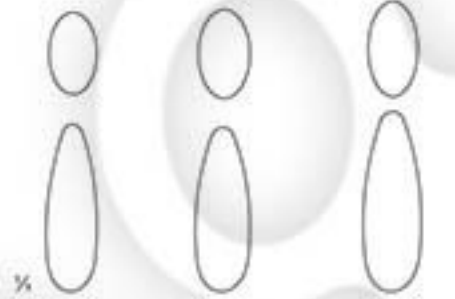

TI-211-1751 13.0 cm / 5"
 TI-211-1752 14.0 cm / 5½"
 TI-211-1753 17.0 cm / 6¾"



Volkman

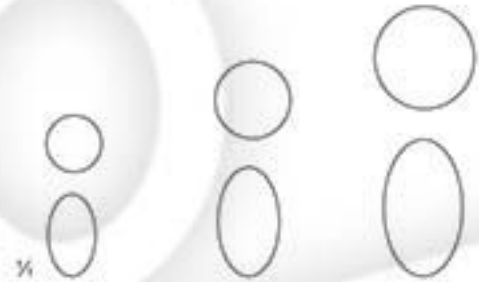

TI-211-1754 13.0 cm / 5"
 TI-211-1755 16.0 cm / 6¼"
 TI-211-1756 20.0 cm / 8"



TI-211-1757
 21.0 cm / 8¼"

oval/round



Williger
 13.5 cm / 5¼"

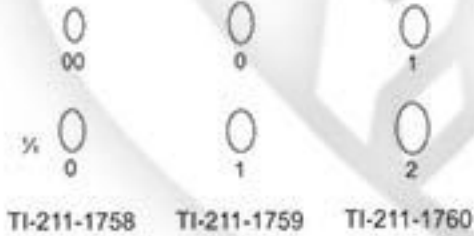

TI-211-1758 TI-211-1759 TI-211-1760



Martini
 13.5 cm / 5¼"

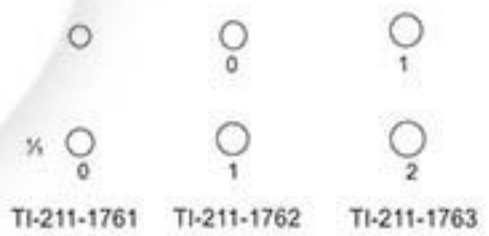

TI-211-1761 TI-211-1762 TI-211-1763



Spinal Fusion Curettes
23.0 cm / 9", reverse angle

- TI-212-1764 - Size 5-0
- TI-212-1765 - Size 4-0
- TI-212-1766 - Size 3-0
- TI-212-1767 - Size 2-0
- TI-212-1768 - Size 0
- TI-212-1769 - Size 1
- TI-212-1770 - Size 2
- TI-212-1771 - Size 3
- TI-212-1772 - Size 4
- TI-212-1773 - Size 5
- TI-212-1774 - Size 6



Bruns Oval Cup Curettes
23.0 cm / 9", straight,
solid hexagonal handle

- TI-212-1775 - Size 3-0
- TI-212-1776 - Size 2-0
- TI-212-1777 - Size 0
- TI-212-1778 - Size 1
- TI-212-1779 - Size 2
- TI-212-1780 - Size 3
- TI-212-1781 - Size 4
- TI-212-1782 - Size 5
- TI-212-1783 - Size 6



**Semmes (Howard)
Spinal Curettes**
23.0 cm / 9" 4x7 mm cup

- TI-212-1784 - Straight
- TI-212-1785 - Slight Angle
- TI-212-1786 - Acute Angle

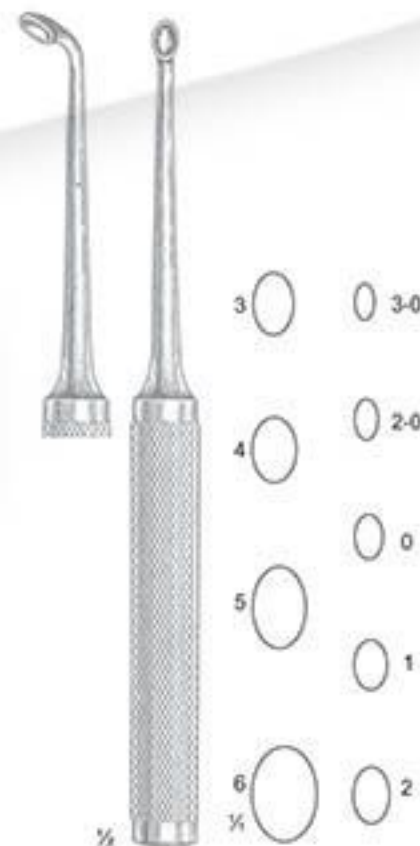

Cobb-Type Oval Cup Curettes
27.9 cm / 11", hollow knurled handle

- | Straight | Angled Tip | Size |
|-------------|-------------|----------|
| TI-212-1787 | TI-212-1796 | Size 3-0 |
| TI-212-1788 | TI-212-1797 | Size 2-0 |
| TI-212-1789 | TI-212-1798 | Size 0 |
| TI-212-1790 | TI-212-1799 | Size 1 |
| TI-212-1791 | TI-212-1800 | Size 2 |
| TI-212-1792 | TI-212-1801 | Size 3 |
| TI-212-1793 | TI-212-1802 | Size 4 |
| TI-212-1794 | TI-212-1803 | Size 5 |
| TI-212-1795 | TI-212-1804 | Size 6 |

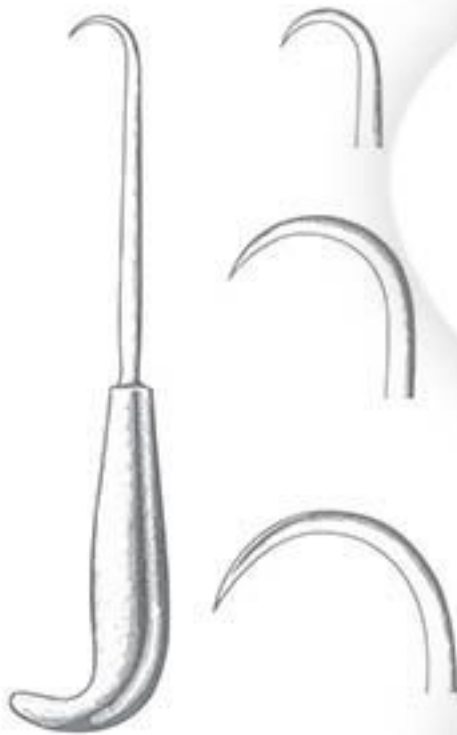

Bone Hooks
23.0 cm / 9"

- TI-213-1805 - 9.5 mm / 3/8", hook
- TI-213-1806 - 19 mm / 3/4", hook
- TI-213-1807 - 25 mm / 1", hook



Volkman Bone Currettes
double ended

- TI-213-1808 - 13.0 cm / 5", one round and one oval cup, 10.0 mm and 6.3 mm x 6.8 mm
- TI-213-1809 - 16.5 cm / 6 1/2", two oval cups, 7.5 mm x 14 mm and 9 mm x 22 mm
- TI-213-1810 - 16.5 cm / 6 1/2", one round and one oval cup, 14 mm and 7 mm x 9 mm
- TI-213-1811 - 20.0 cm / 8", one round and one oval cup, 17.5 mm and 9 mm x 11 mm



Scoville Disc Currettes
25.0 cm / 10", 4 x 10 mm cup

- TI-213-1812 - Straight
- TI-213-1813 - Reverse angled
- TI-213-1814 - Angled



Cone Ring Curettes

23.0 cm / 9"

- TI-214-1815 - Straight, Size 1, 8mm diameter
- TI-214-1816 - Straight, Size 2, 6mm diameter
- TI-214-1817 - Straight, Size 3, 3mm diameter
- TI-214-1818 - Angular, Size 1, 8mm diameter
- TI-214-1819 - Angular, Size 2, 6mm diameter
- TI-214-1820 - Angular, Size 3, 3mm diameter

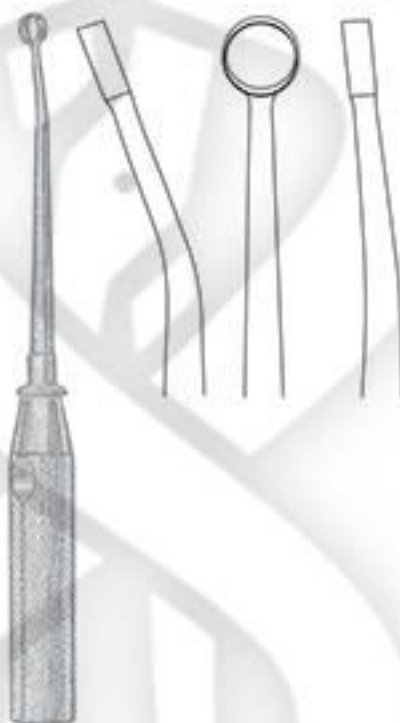

Cone Ring Curettes

23.0 cm / 9", 8mm cup

- TI-214-1821 - 5° Angle
- TI-214-1822 - 30° Angle



Epstein Spinal Curettes

20.0 cm / 8", reverse angle

- TI-214-1823 - Size 3-0
- TI-214-1824 - Size 2-0
- TI-214-1825 - Size 0

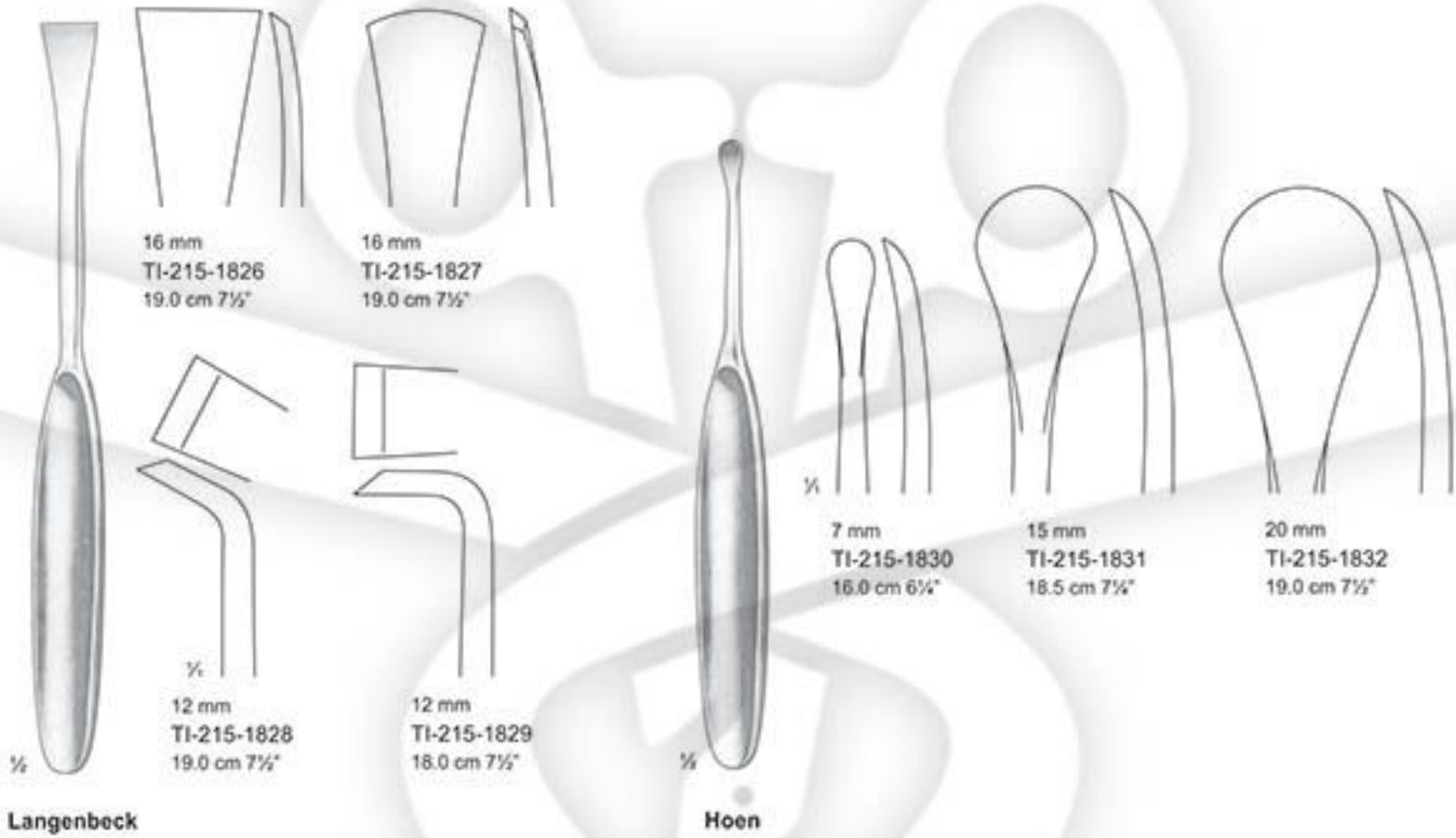

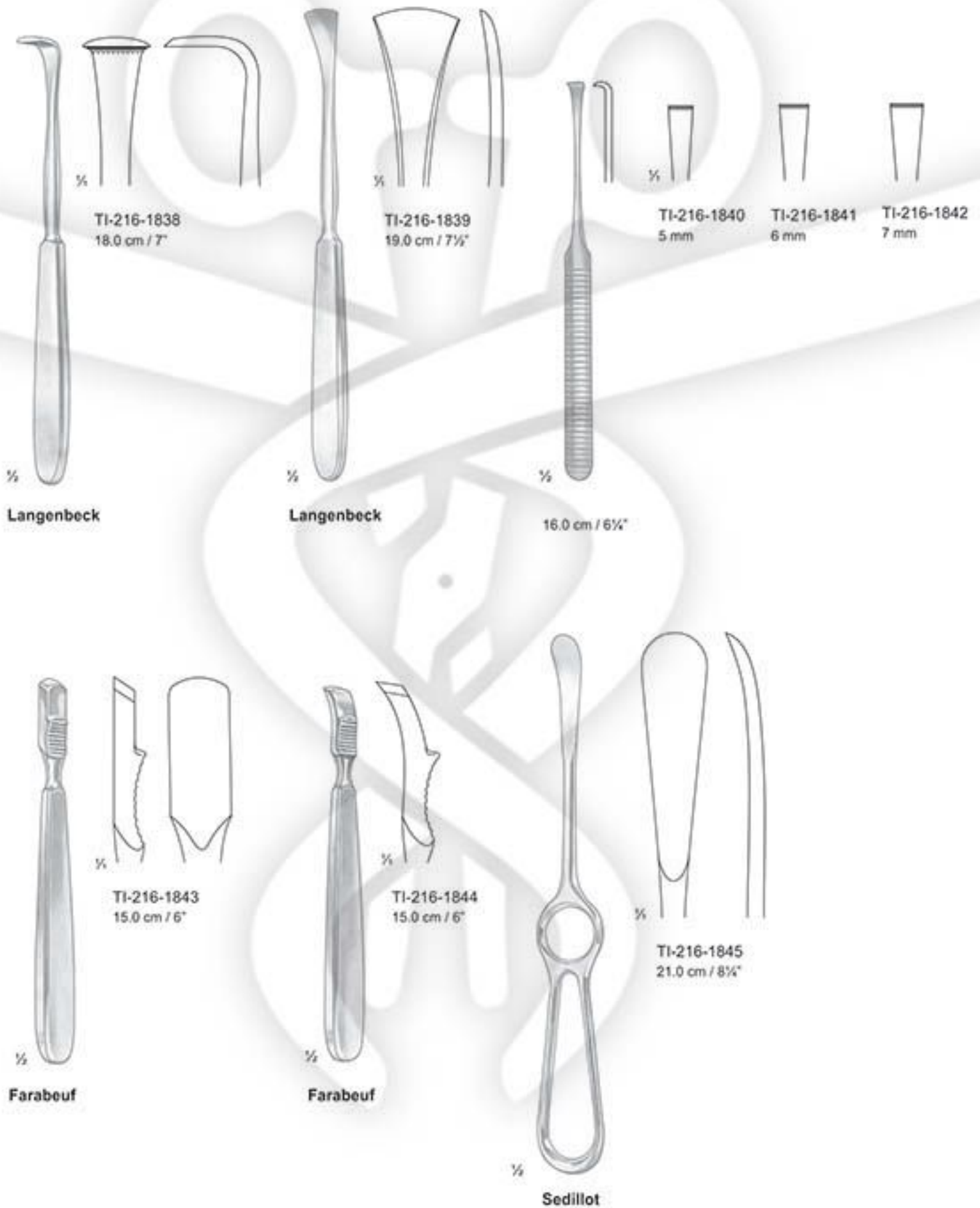



Williger



Williger

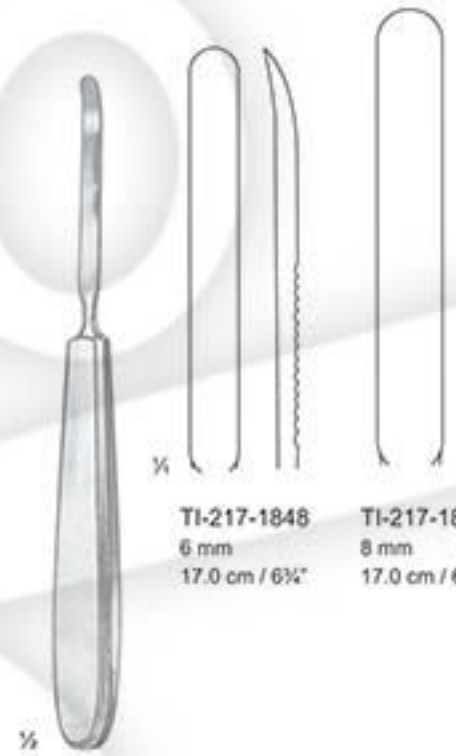

Doyen
17.0 cm / 6 3/4"

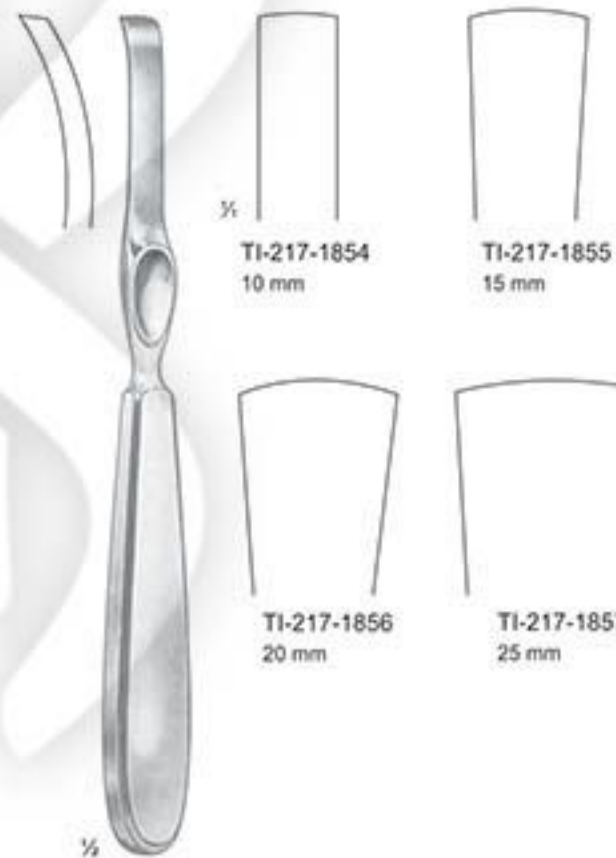
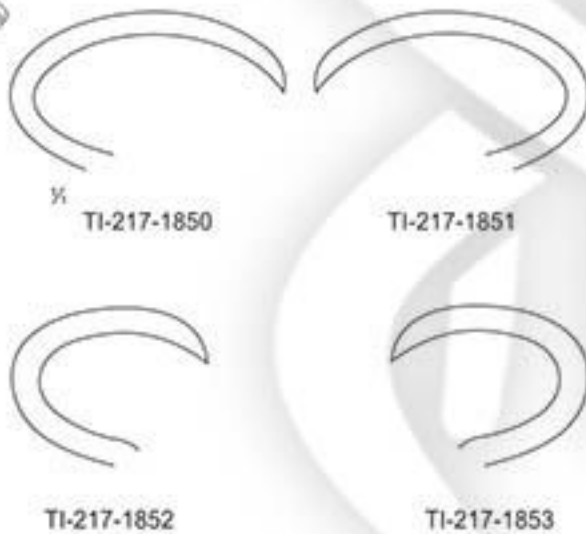

Lambotte
21.0 cm / 8 1/4"

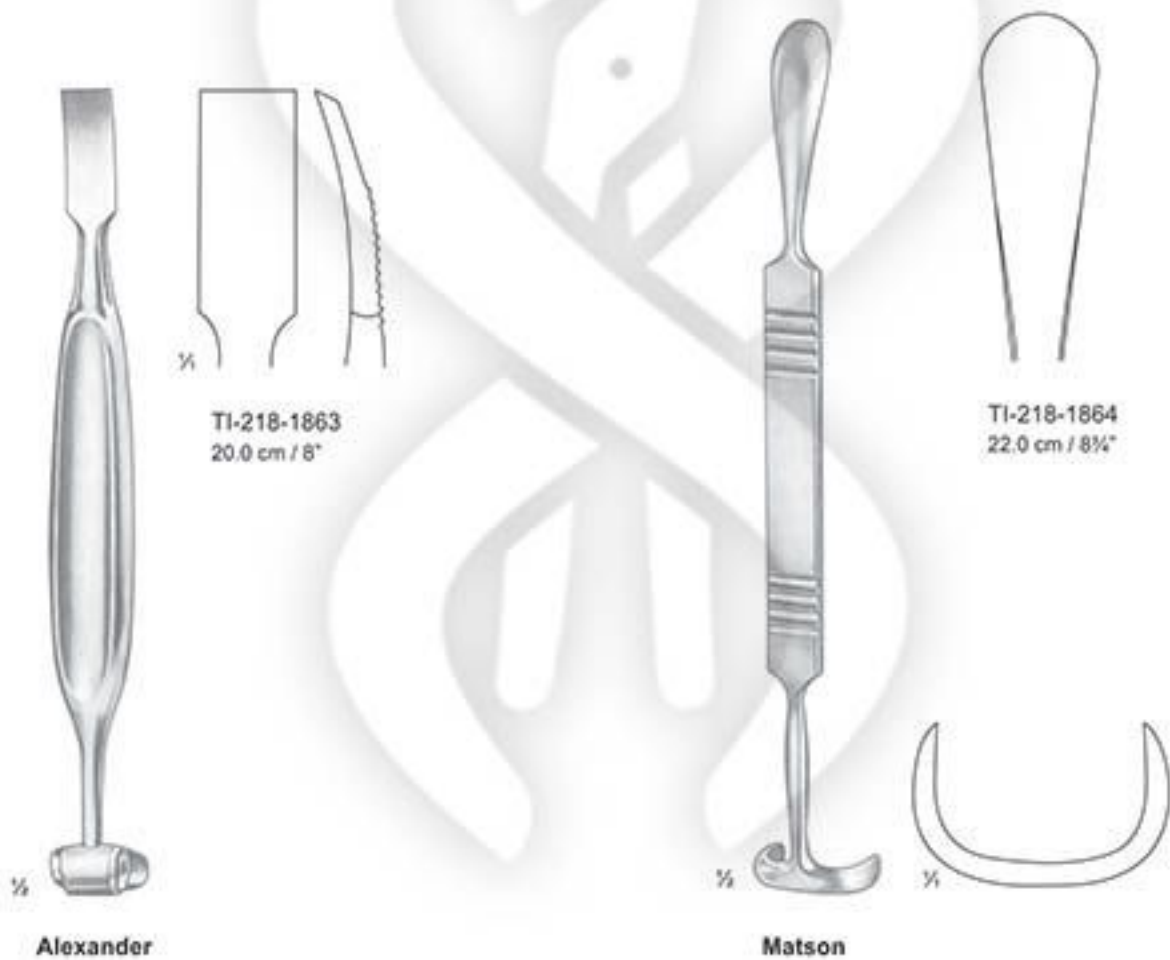

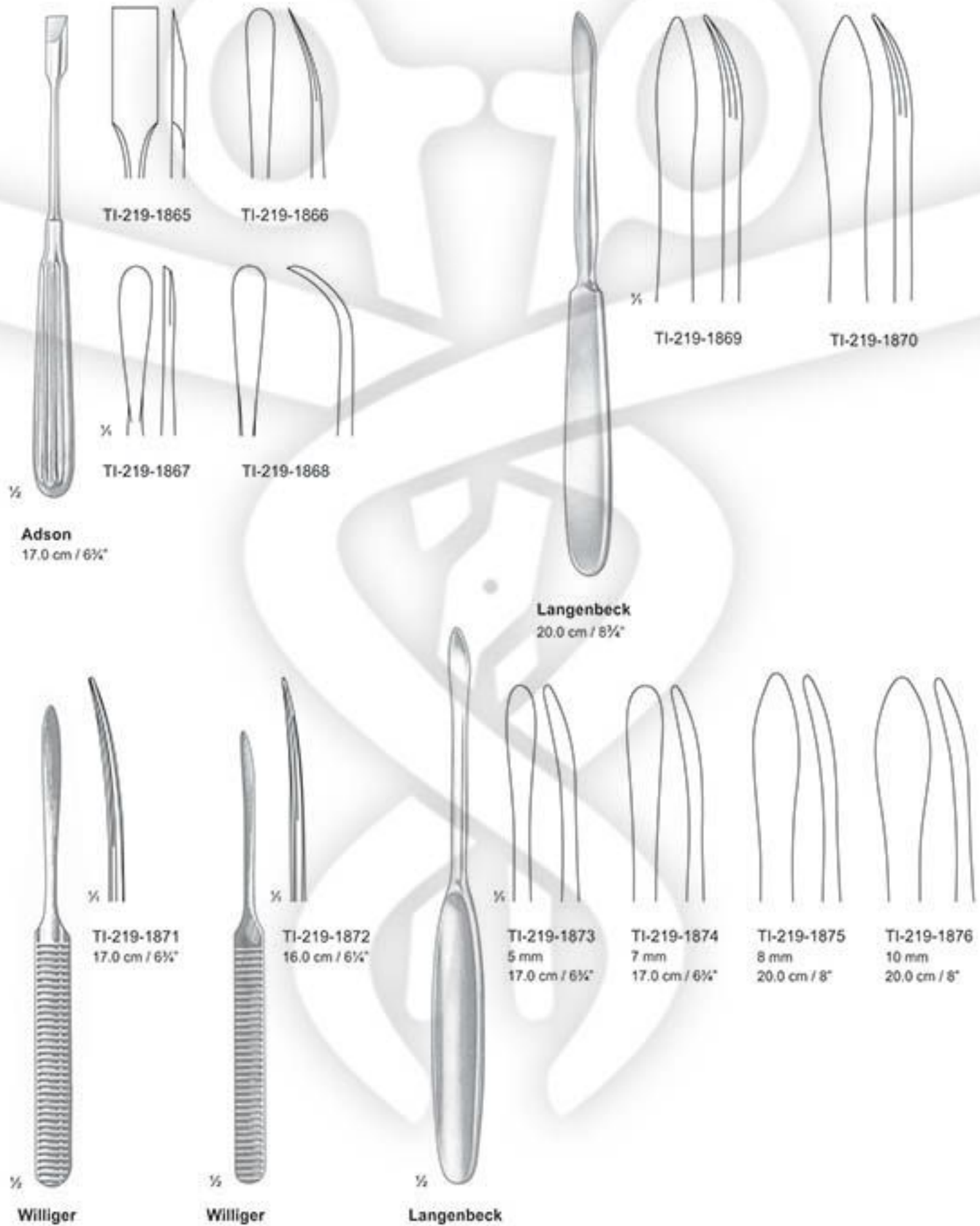

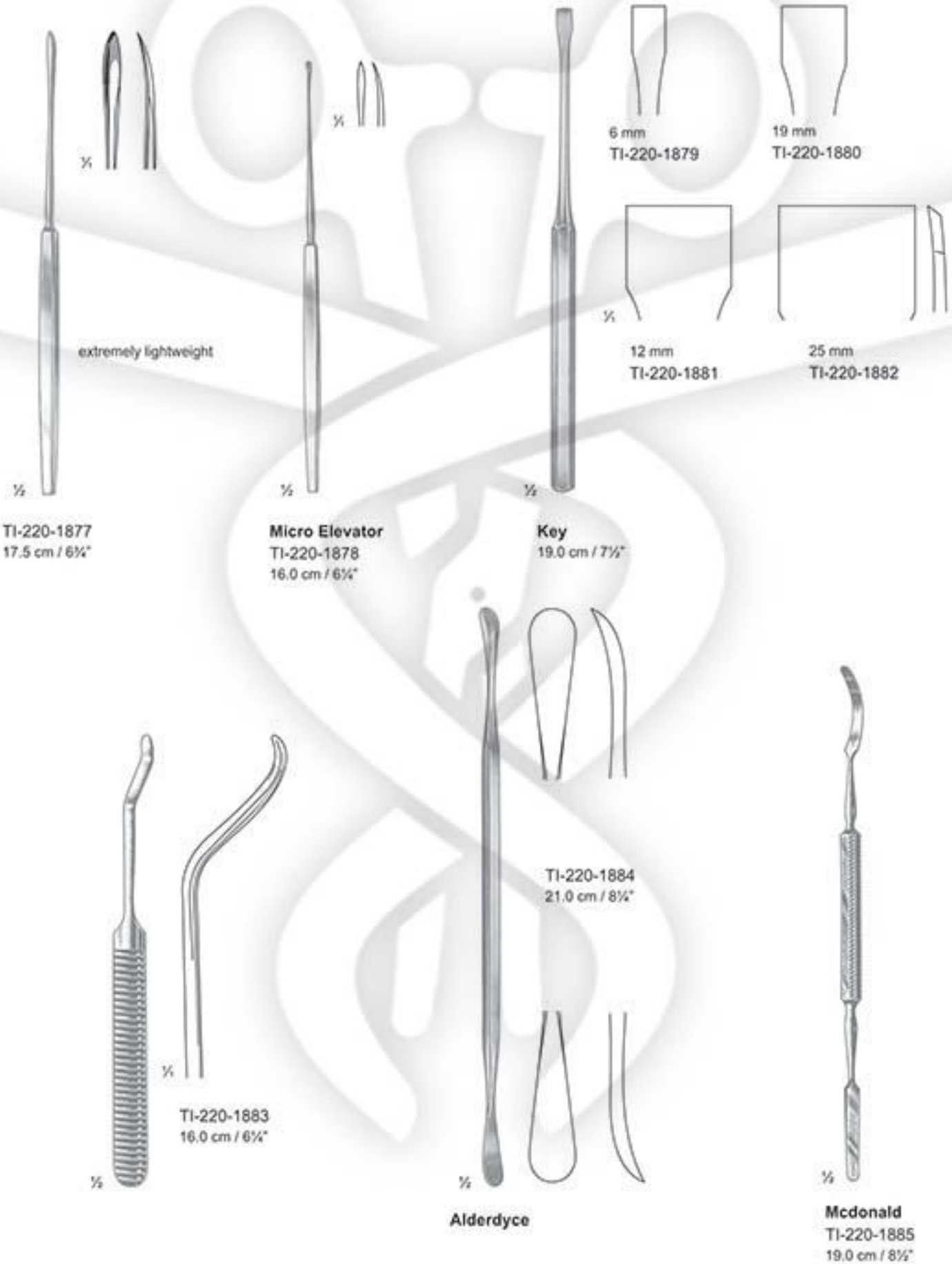

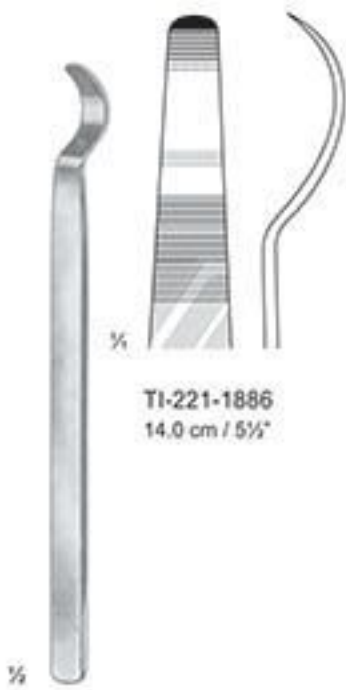

TI-221-1886
14.0 cm / 5½"



Mini-Hohmann
TI-221-1887
16.0 cm / 6¼"



Mini-Hohmann
TI-221-1888
16.0 cm / 6¼"



¼

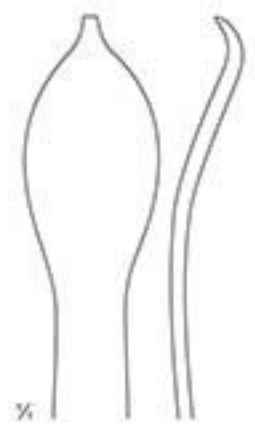

¼



¼

TI-221-1889
15 mm



¼

TI-221-1890
16 mm







1/2

Bennett
TI-224-1900
24.0 cm / 9 1/2"



1/2

Blount
TI-224-1901
26.0 cm / 10 1/4"



1/2

Blount
TI-224-1902
26.0 cm / 10 1/4"

Spinal Retractors



1/2

Blount Kneel Retractors
TI-224-1903
17.5 cm / 7"



1/2



1/2

Taylor Spinal Retractors
16.5 cm / 6 1/2"
100 x 30 mm 75 x 30 mm

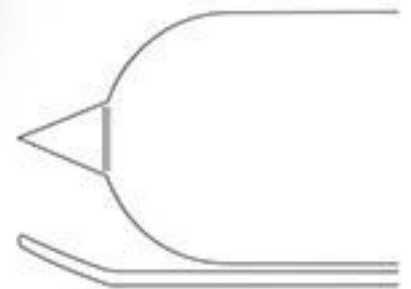

TI-224-1904
100 x 30 mm

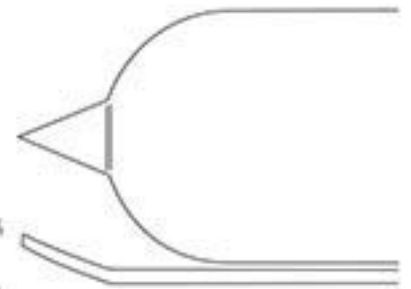

1/2

BI-224-1905
75 x 30 mm



Mod. Schweden
17.0 cm / 6 3/4"



TI-225-1906
left cutting



TI-225-1907
right cutting



Bircher
19.0 cm / 7 1/2"



TI-225-1908



TI-225-1909



Smillie
17.0 cm / 6 3/4"



TI-225-1910



TI-225-1911



TI-225-1912



Stryker-Scholl
19.0 cm / 7 1/2"



Slightly curved
TI-225-1913



Strongly curved
TI-225-1914



TI-225-1915
spare blades

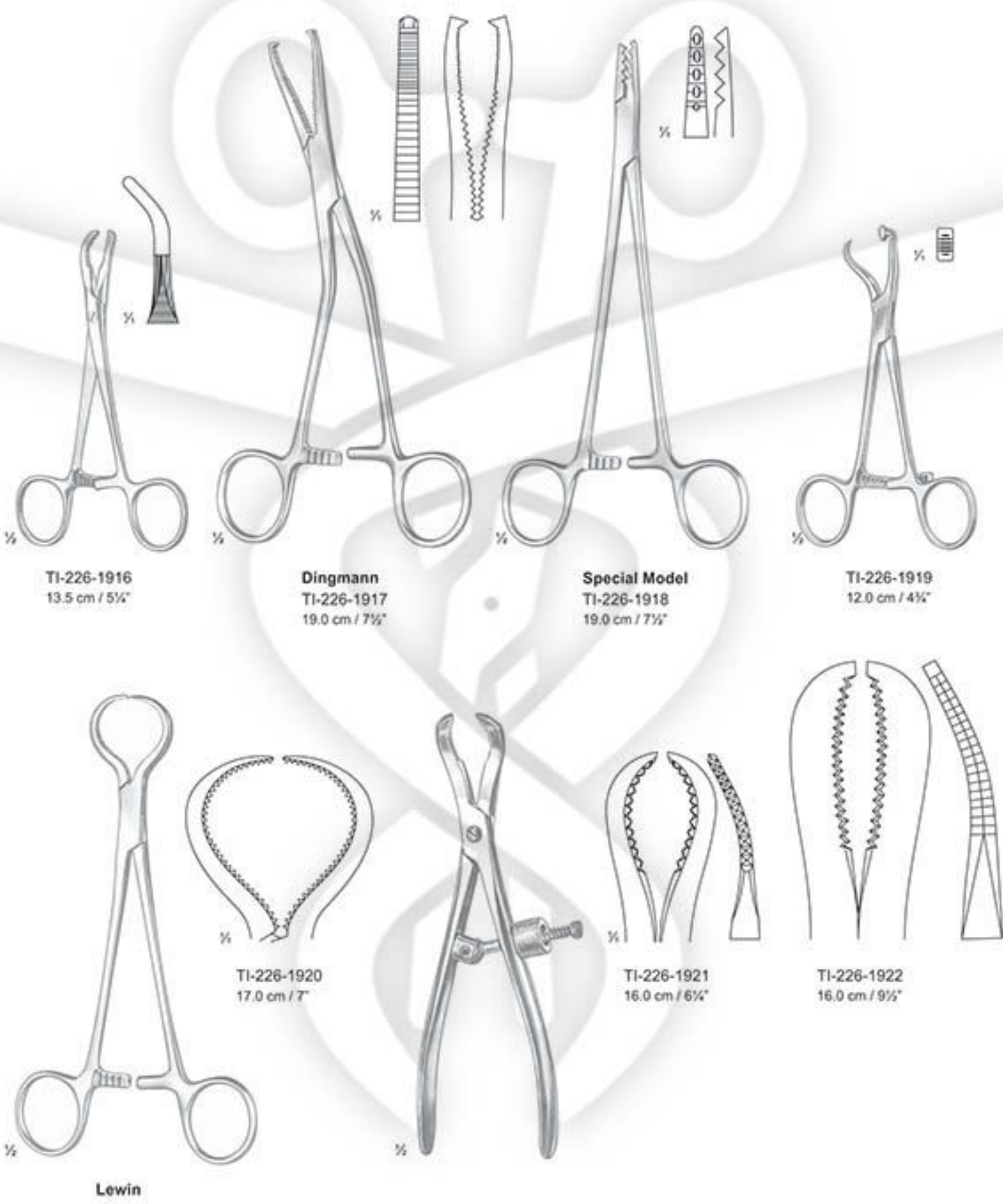

TI-226-1916
13.5 cm / 5 1/4"

Dingmann
TI-226-1917
19.0 cm / 7 1/2"

Special Model
TI-226-1918
19.0 cm / 7 1/2"

TI-226-1919
12.0 cm / 4 1/4"

TI-226-1920
17.0 cm / 7"

TI-226-1921
16.0 cm / 6 1/4"

TI-226-1922
16.0 cm / 9 1/4"

Lewin



TI-227-1923
14.0 cm / 5½"



TI-227-1924
13.5 cm / 5¼"



Langenbeck
TI-227-1925
21.0 cm / 8¼"



Fergusson

TI-227-1926
21.0 cm / 8¼"



Frosch

TI-227-1927
18.0 cm / 7"



TI-227-1928
20.0 cm / 8"

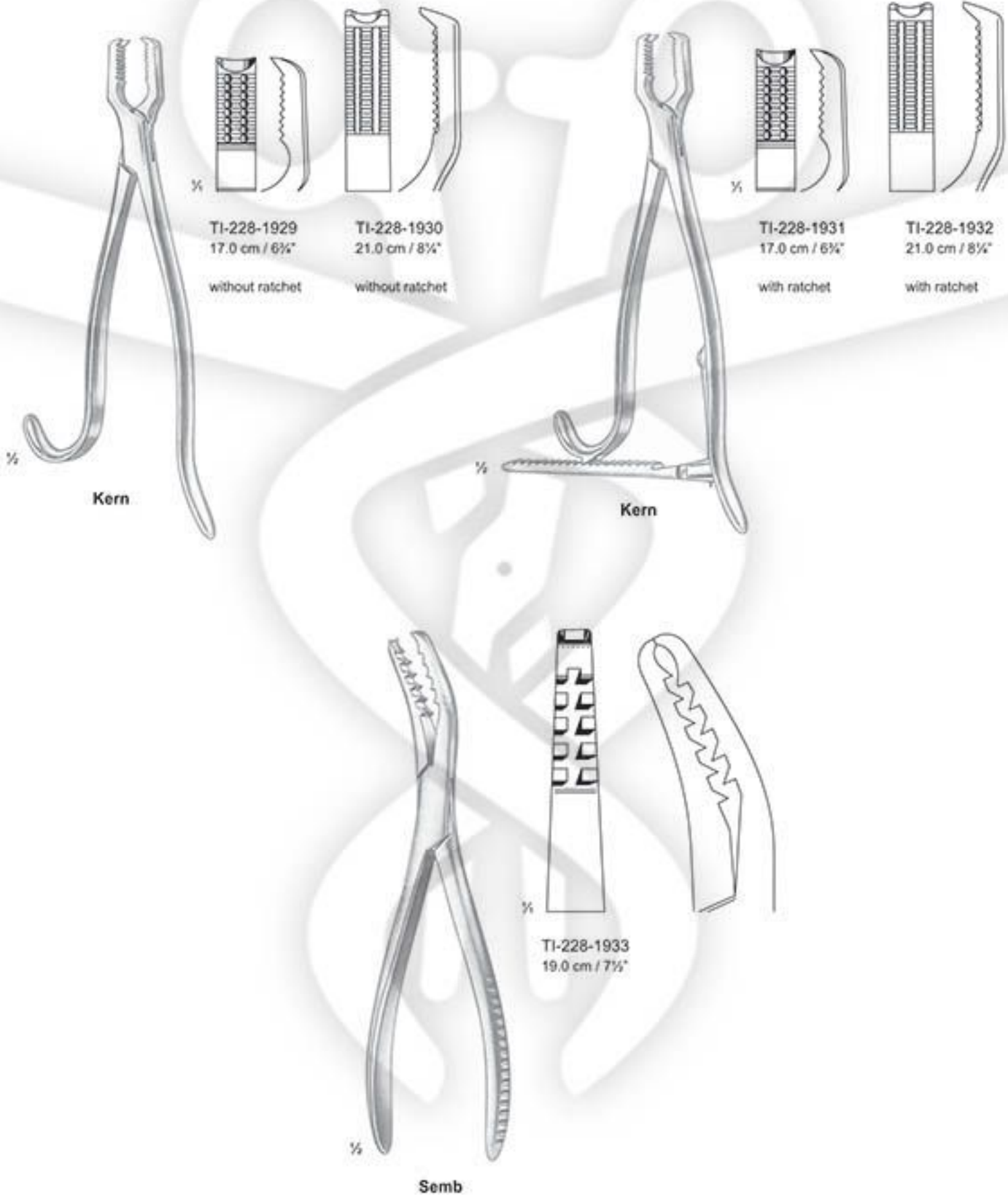

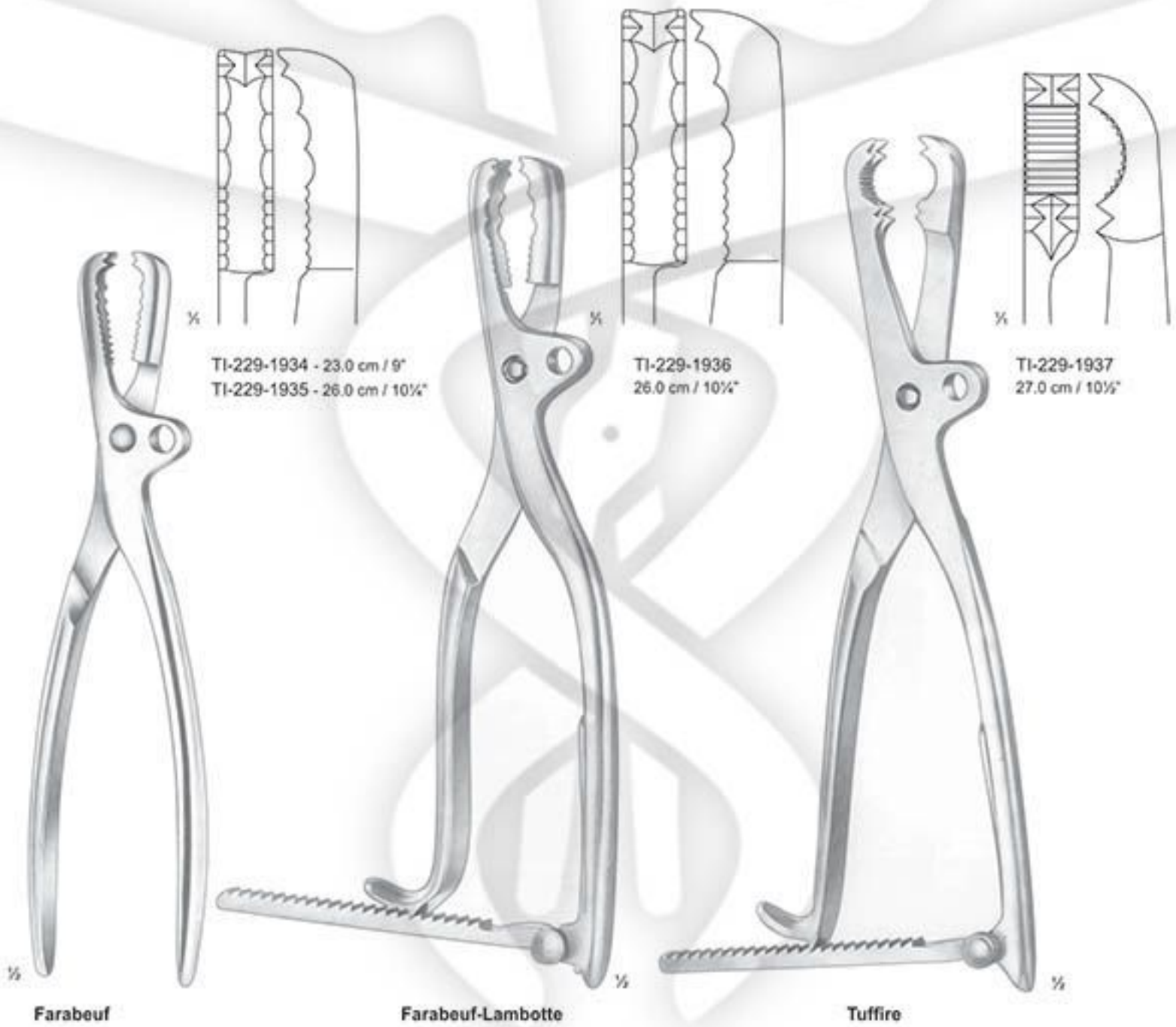

A d j u s t a b l e

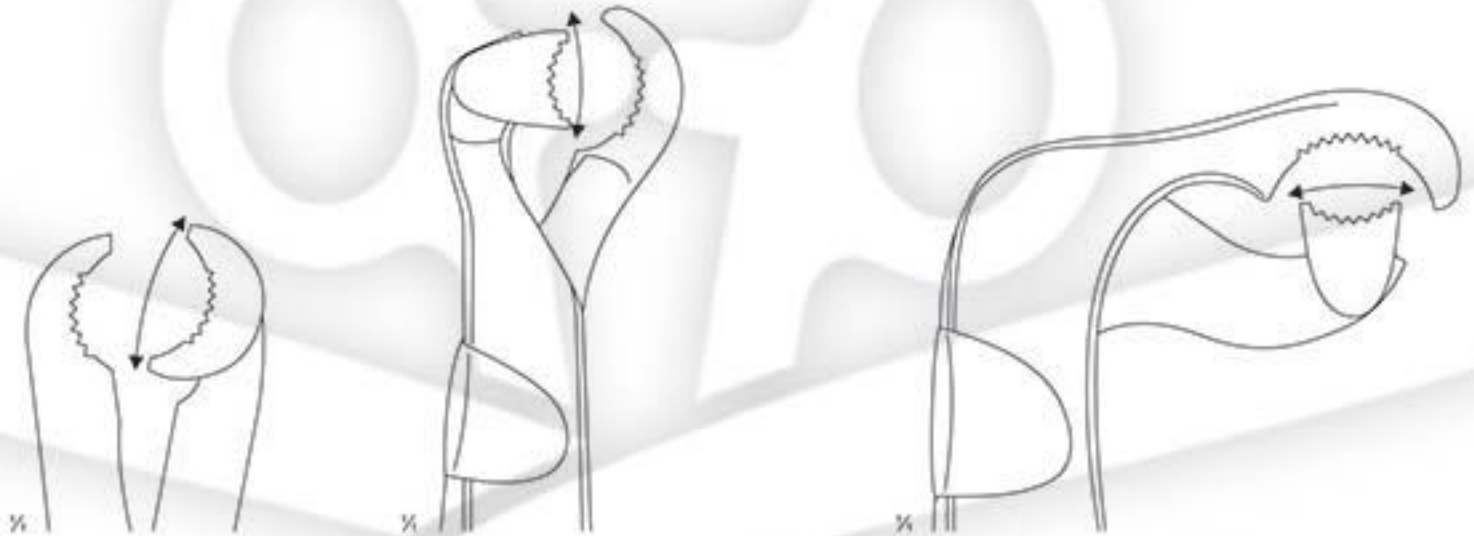

Lambotte
 TI-230-1938 - 22.0 cm / 8½"
 TI-230-1939 - 27.0 cm / 10"
 TI-230-1940 - 30.0 cm / 12"

Lambotte
 TI-230-1941 - 22.0 cm / 8½"
 TI-230-1942 - 26.0 cm / 10¼"
 TI-230-1943 - 33.0 cm / 13"

Lambotte
 TI-230-1944 - 19.0 cm / 7½"
 TI-230-1945 - 23.0 cm / 9"
 TI-230-1946 - 26.0 cm / 10¼"



TI-231-1947
23.0 cm / 9"

TI-231-1948
25.0 cm / 10"

TI-231-1949
28.0 cm / 11"



TI-231-1950
28.0 cm / 11"



Ulrich



Ulrich

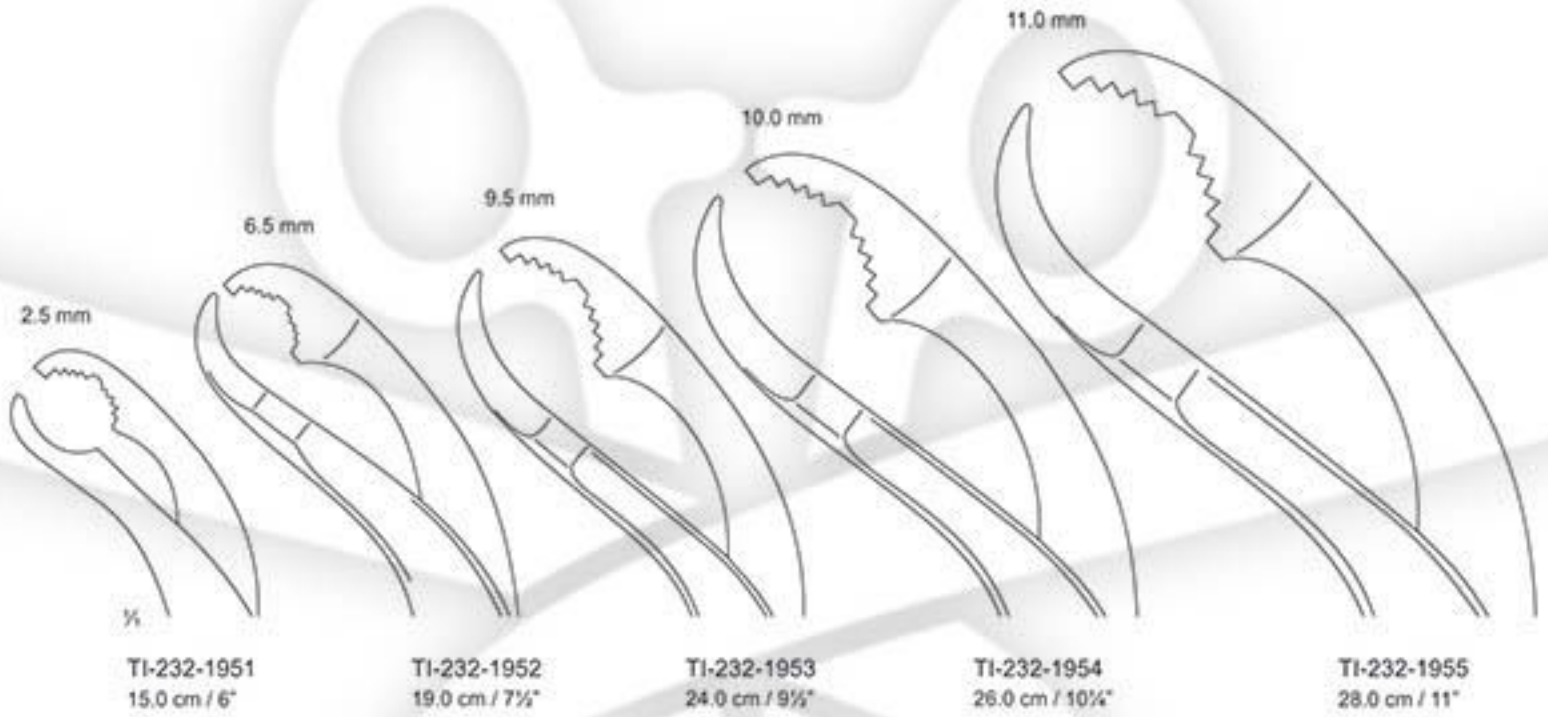

Self-centering forceps
with thread fixation



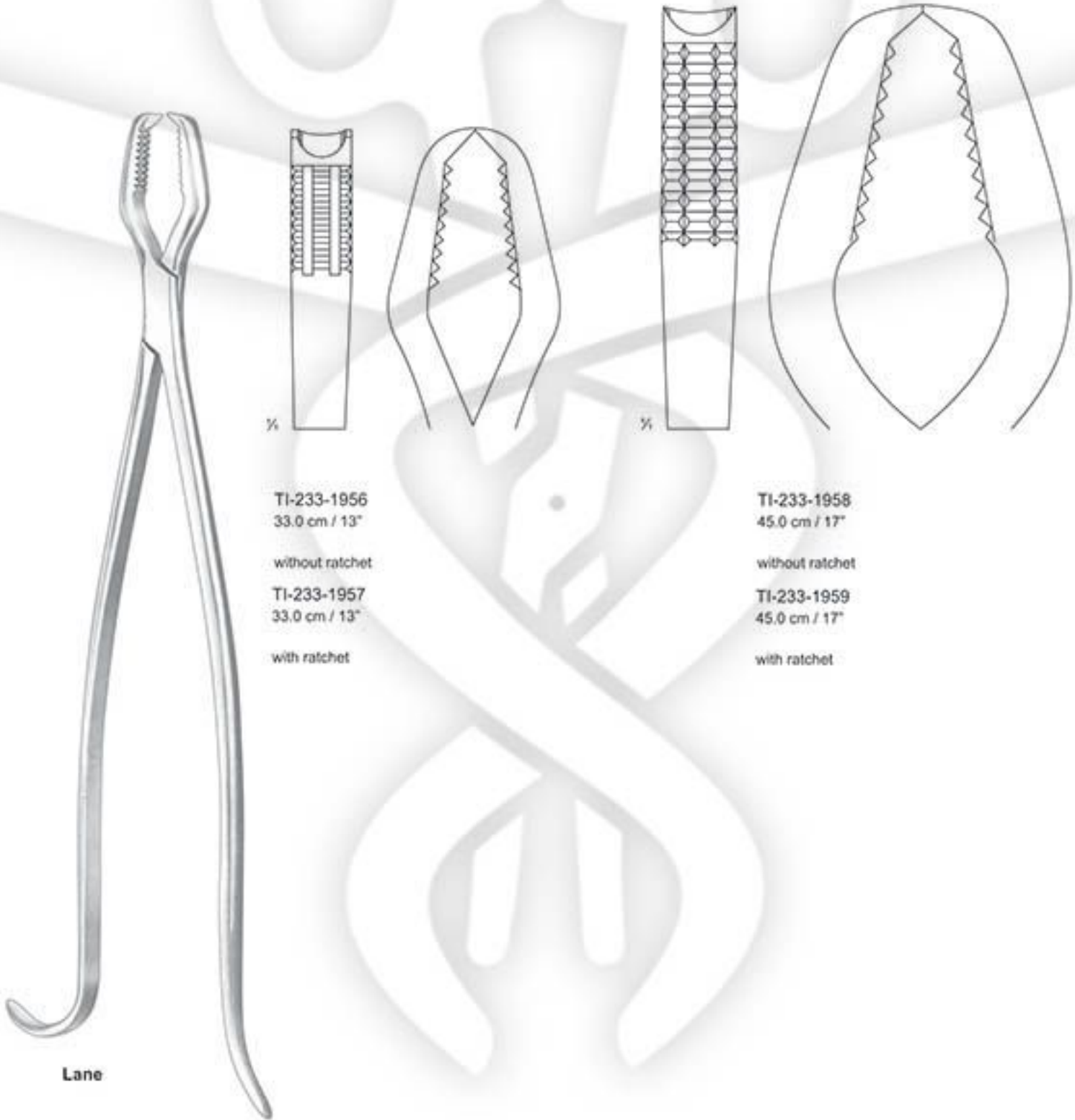

Lane

TI-233-1956
33.0 cm / 13"

without ratchet

TI-233-1957
33.0 cm / 13"

with ratchet

TI-233-1958
45.0 cm / 17"

without ratchet

TI-233-1959
45.0 cm / 17"

with ratchet

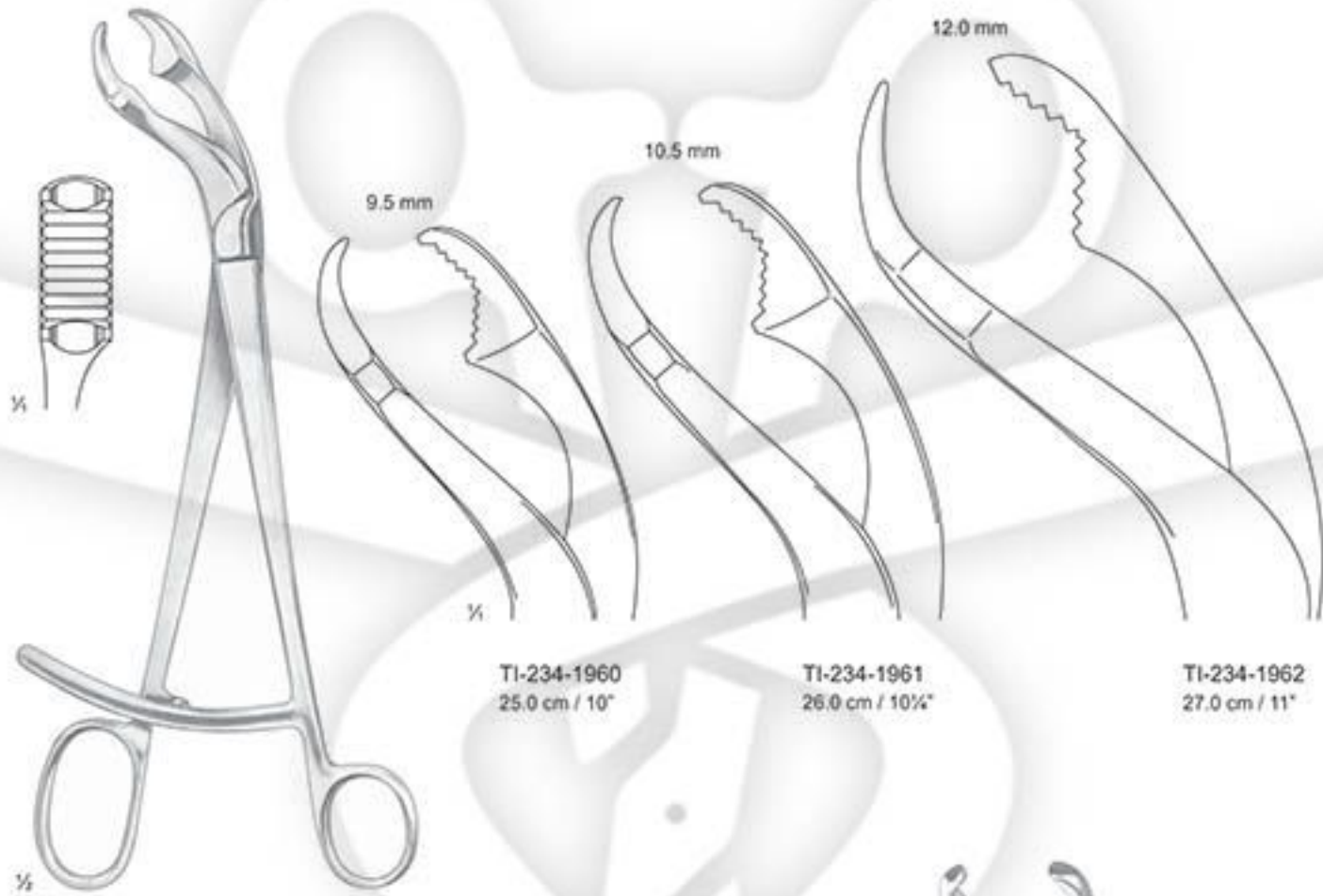

Verbrugge



Verbrugge

Amputating Retractor

Percy
TI-234-1964



Stellbrink
17.0 cm / 6 $\frac{3}{4}$ "

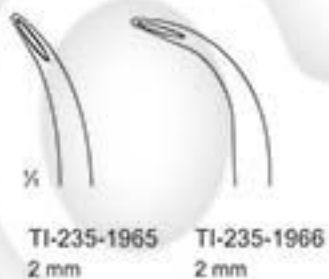

TI-235-1965
2 mm

TI-235-1966
2 mm



Mini-Friedman
TI-235-1967
13.0 cm / 5"



Friedman
TI-235-1968
14.0 cm / 5 $\frac{1}{2}$ "



Cleveland
TI-235-1969
14.0 cm / 5 $\frac{1}{2}$ "



Cleveland
TI-235-1970
17.0 cm / 6 $\frac{3}{4}$ "



Universal
TI-235-1971
13.5 cm / 5 $\frac{1}{4}$ "

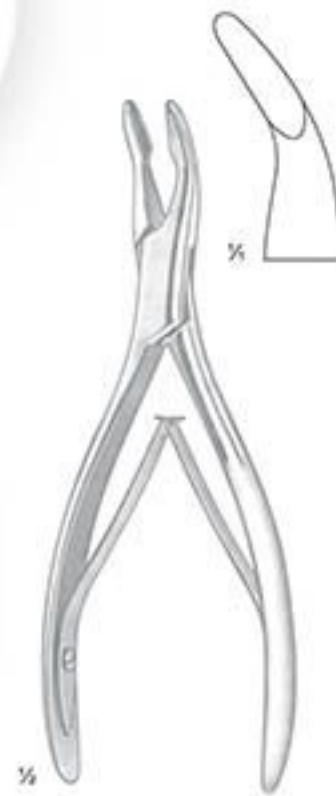

Mead
TI-235-1972
16.5 cm / 6 $\frac{1}{2}$ "

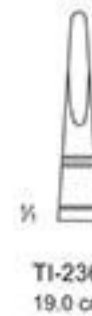
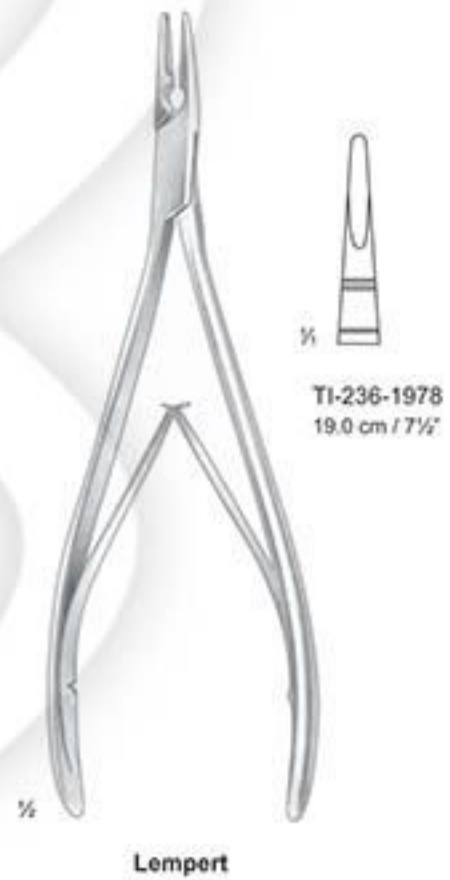
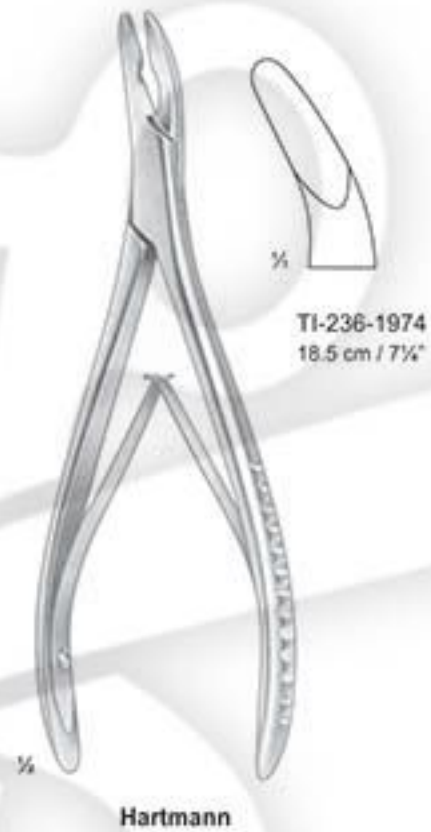
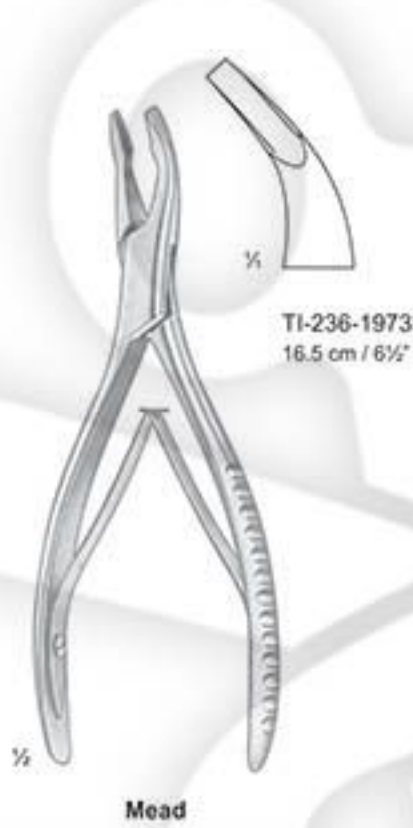



Blumenthal



TI-237-1979



TI-237-1980



TI-237-1981



Luer
17.0 cm / 6 3/4"



TI-237-1982



TI-237-1983



Luer
15.0 cm / 6"



TI-237-1984



TI-237-1985



TI-237-1986

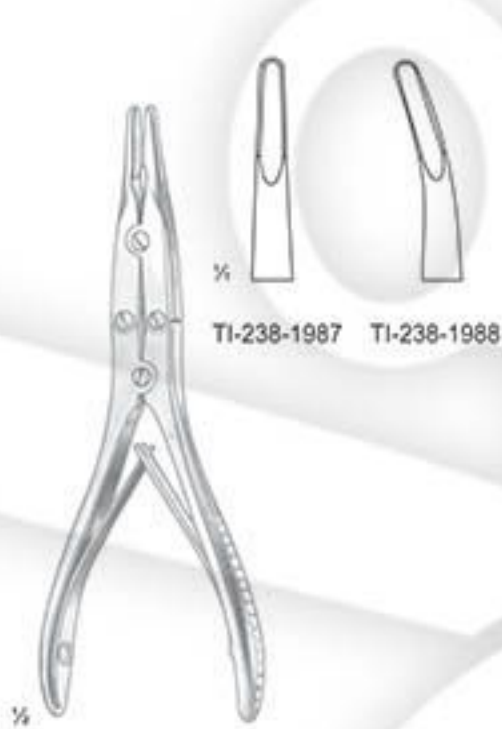

Bohler



Beyer



Zaufal-Jansen



Mayfield



Marquardt



Ruskin

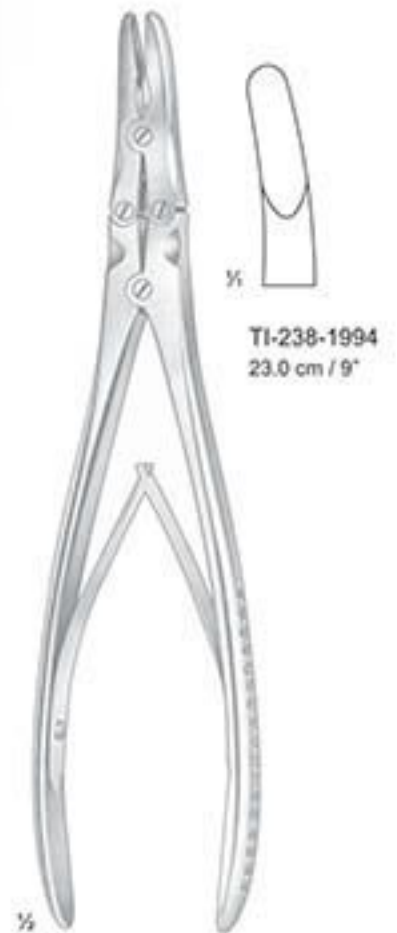

Ruskin



TI-239-1995
22.5 cm / 9"



TI-239-1996
23.0 cm / 9"



TI-239-1997



TI-239-1998



TI-239-1999



TI-239-2000
23.0 cm / 9"



TI-240-2001



TI-240-2002



TI-240-2003



TI-240-2004



TI-240-2005



Leksell-Stille
22.0 cm / 9 $\frac{1}{2}$ "



Frykholm
24.0 cm / 9 $\frac{1}{2}$ "



Stille-Luer
22.0 cm / 8 $\frac{3}{4}$ "



TI-241-2006 - 23.0 cm / 9"
TI-241-2007 - 27.0 cm / 10½"



TI-241-2008 - 23.0 cm / 9"
TI-241-2009 - 27.0 cm / 10½"



TI-241-2010



TI-241-2011



Stille-Luer



Sauerbruch
30.0 cm / 12"



1/2

TI-242-2012
20.0 cm / 8"

Markwalder



1/2

TI-242-2013
19.0 cm / 7 1/2"

Cottle-Kazanjian



TI-242-2014
14.0 cm / 5 1/2"



TI-242-2015
17.0 cm / 6 3/4"



TI-242-2018
14.0 cm / 5 1/2"



TI-242-2019
17.0 cm / 6 3/4"



1/2

TI-242-2016
19.0 cm / 7 1/2"

Liston



TI-242-2017
22.0 cm / 8 3/4"



1/2

TI-242-2020
19.0 cm / 7 1/2"

Liston



TI-242-2021
22.0 cm / 8 3/4"

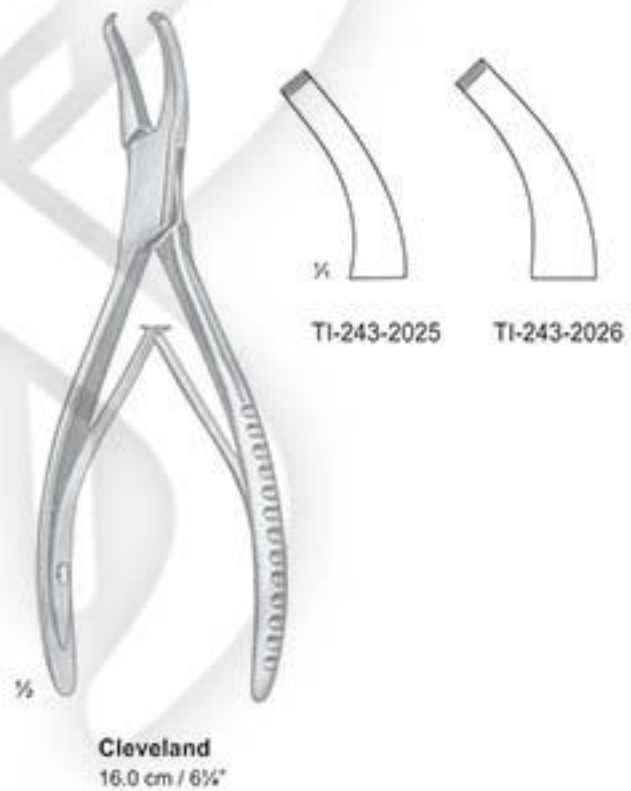
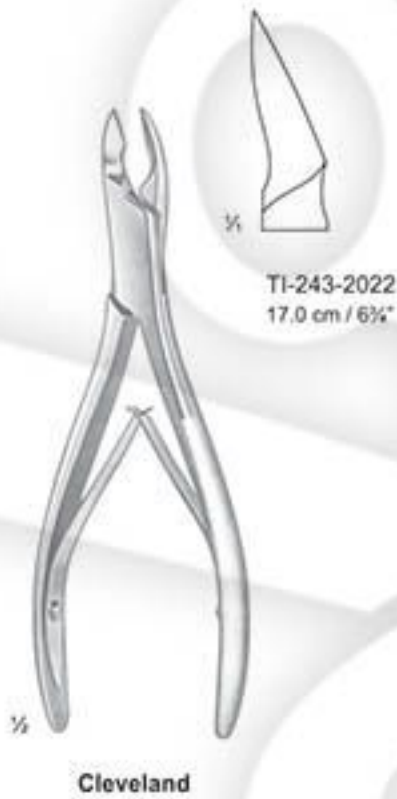



TI-244-2027
15.0 cm / 6"



TI-244-2028
15.0 cm / 6"



TI-244-2029
15.0 cm / 6"



Ruskin-Liston



TI-244-2030
18.5 cm / 7 1/4"



TI-244-2031
18.5 cm / 7 1/4"

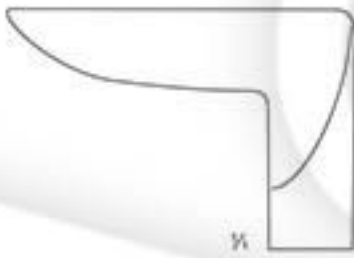

1/2

TI-245-2032
27.0 cm / 10 1/2"



1/2

TI-245-2033
27.0 cm / 10 1/2"



1/2

TI-245-2034
23.0 cm / 9 1/4"



1/2

TI-245-2035
27.0 cm / 10 1/2"



1/2

Stille-Liston



1/2

Stille-Liston



1/2

Liston-Key



Tl-246-2036
27.0 cm / 10 $\frac{1}{2}$ "

Liston-Key



Tl-246-2037
24.0 cm / 9 $\frac{1}{2}$ "

Semb



TI-247-2039

Special Model
TI-247-2038
17.0 cm / 6 $\frac{3}{4}$ "



TI-247-2041

Walton
TI-247-2040
16.0 cm / 6 $\frac{1}{4}$ "



TI-247-2043

TI-247-2042
17.0 cm / 6 $\frac{3}{4}$ "



Penner
TI-247-2044
15.5 cm / 6"



Radolf
TI-247-2045
13.5 cm / 5 $\frac{1}{4}$ "



Spare saw blade
 TI-248-2046 - 12.0 mm
 TI-248-2047 - 15.0 mm



Charriere
 TI-248-2048
 35.0 cm / 14"



Spare saw blade
 TI-248-2049 - 3 mm
 TI-248-2050 - 5mm
 TI-248-2051 - 7 mm



Helferich-Bier
 TI-248-2052
 39.0 cm / 15½"



Lindemann
 TI-248-2053
 20.0 cm / 8"



Langenbeck
 TI-248-2054
 23.0 cm / 9"



Charriere
 TI-248-2055 - 27 cm / 10½"
 TI-248-2056 - 30 cm / 12"



Satterlee
 TI-248-2057
 31.0 cm / 12½"



TI-249-2058
14.0 cm / 5½"



Perthes
TI-249-2059
21.0 cm / 8¼"



TI-249-2060
14.0 cm / 5½"

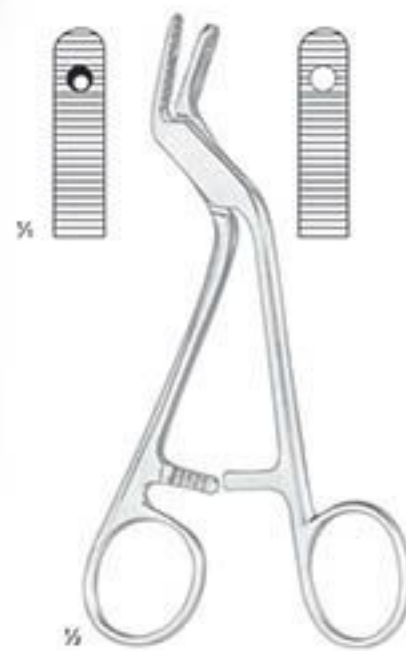

Adson
TI-249-2061
15.0 cm / 6"

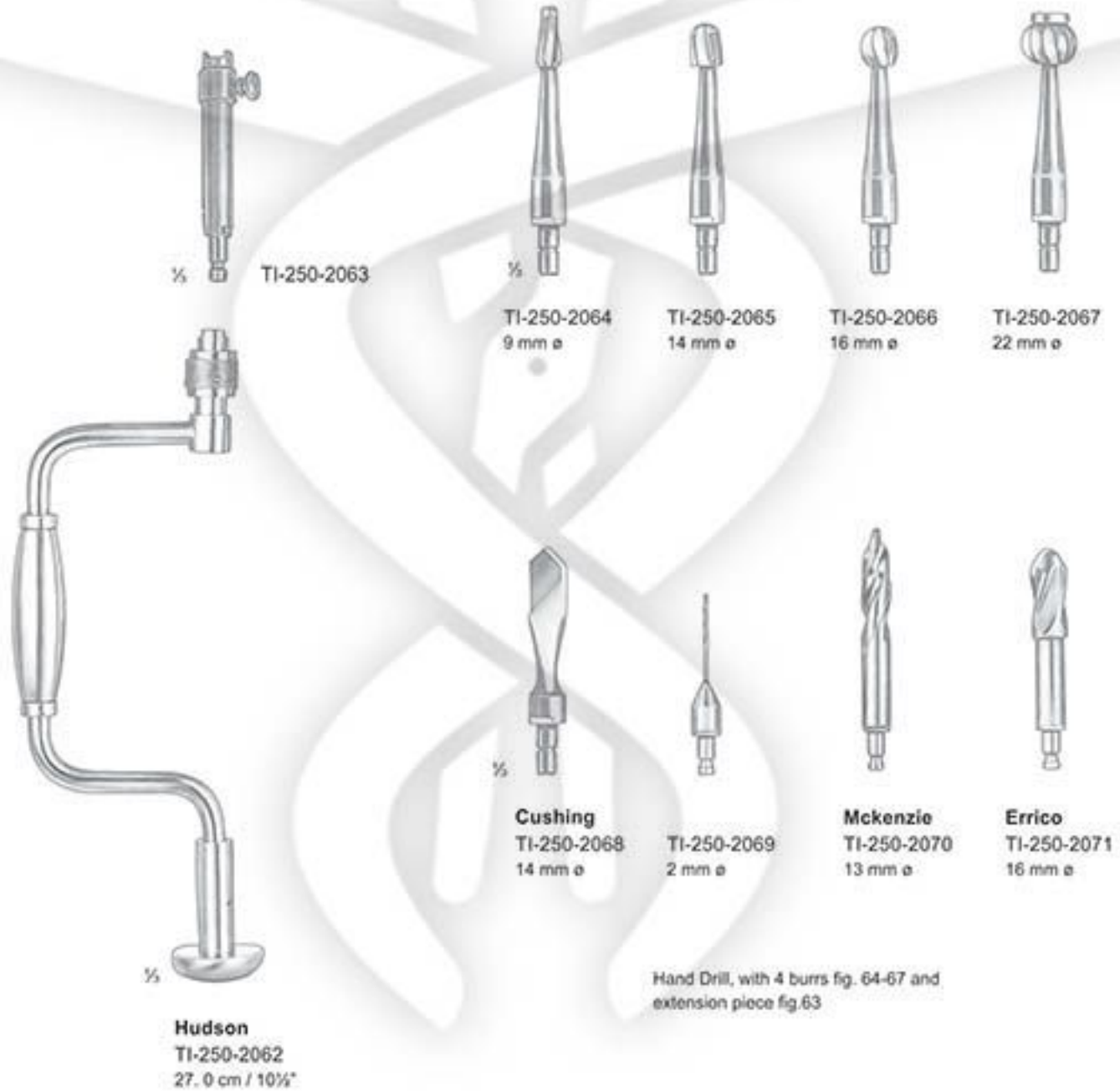



TI-251-2073
18.0 cm / 7"

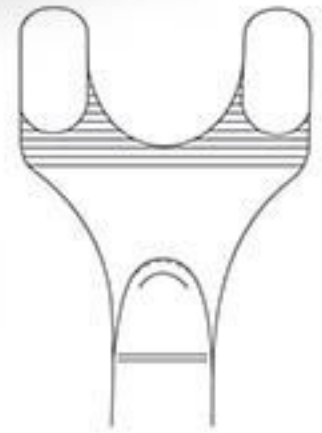

TI-251-2074
20.0 cm / 8"

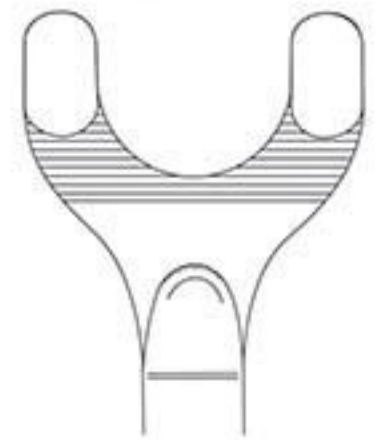

TI-251-2075
22.0 cm / 8 3/4"



Gerster-Lowmann

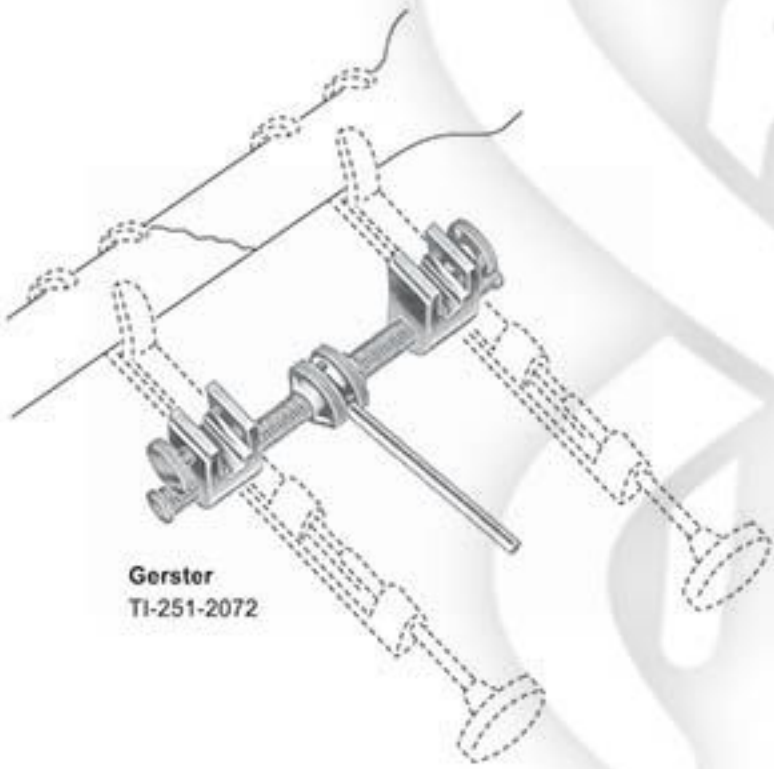

Gerster
TI-251-2072



Tungsten Carbide



TI-253-2083
18.0 cm / 7"



TI-253-2084
18.0 cm / 7"



TI-253-2085
18.0 cm / 7"



TI-253-2086
18.0 cm / 7"



TI-253-2087
18.0 cm / 7"

TC / GOLD

TUNGSTEN CARBIDE
TC GOLD



Parallel Action



TI-253-2088
14.0 cm / 5½"



TI-253-2089
16.0 cm / 6½"
with groove

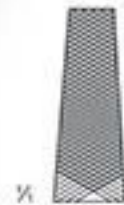

TI-253-2090
17.0 cm / 6¾"



TI-253-2091
17.0 cm / 6¾"

TC / GOLD



TI-254-2092
16.0 cm / 6 1/4"



Diamant
TI-254-2093
16.0 cm / 6 1/4"

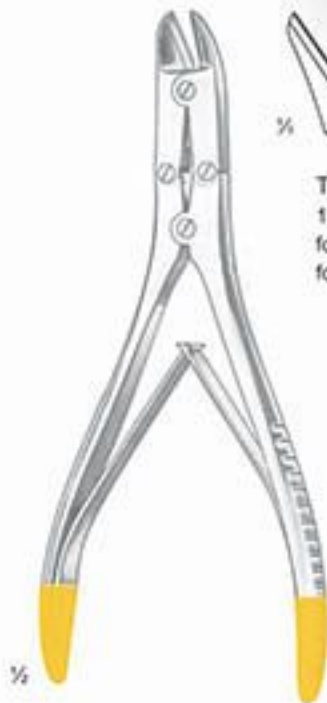

TI-254-2094
16.0 cm / 6 1/4"
for hard wires up to 1.6 mm ø
for soft wires up to 2.0 mm ø

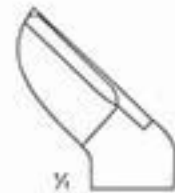

TI-254-2095
22.0 cm / 8 3/4"
for wires up to 2.5 mm ø

TC **GOLD**



TI-255-2096
15.0 cm / 6"



TI-255-2097
24.0 cm / 9 1/2"



TI-255-2098
18.0 cm / 7"



for soft wires
up to 2 mm ø



for soft wires
up to 1.5 mm ø

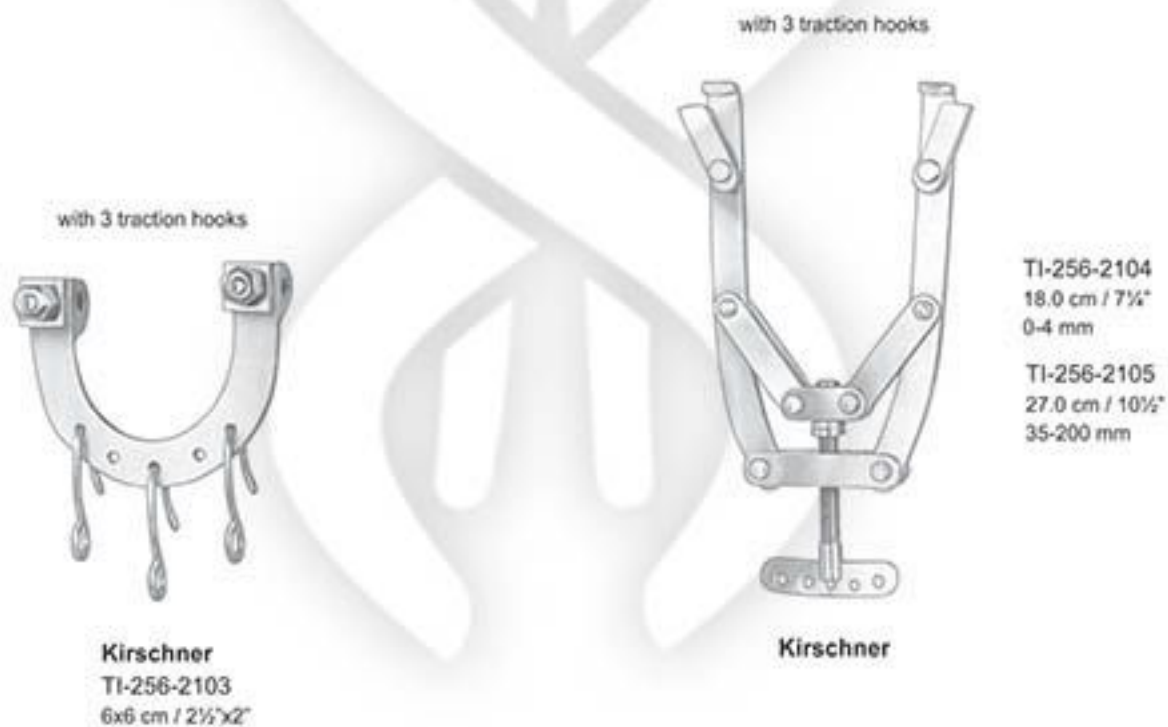
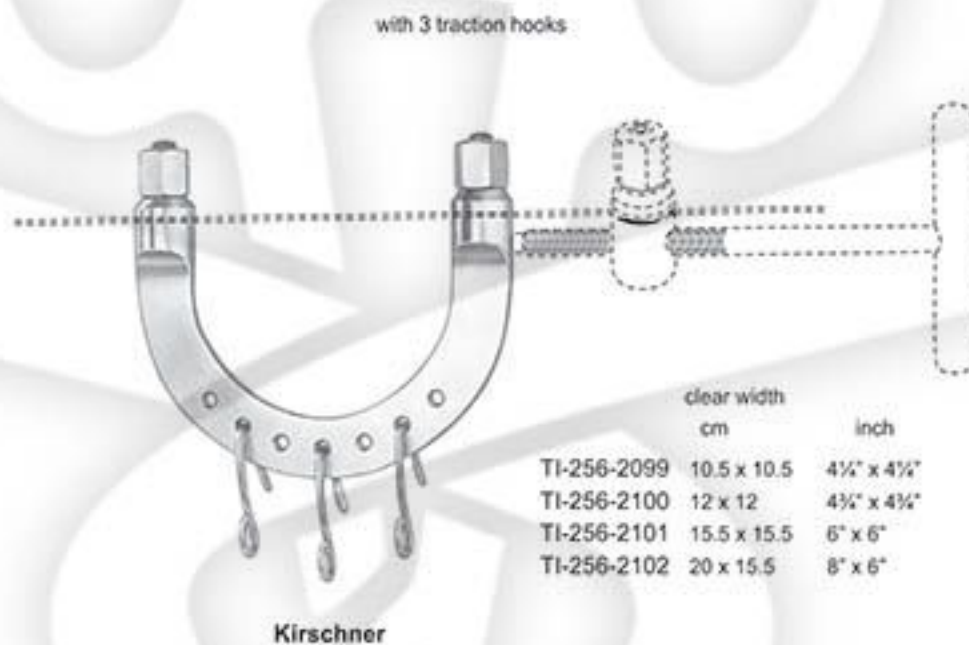



TI-257-2106



TI-257-2107
19.0 cm / 7 1/2"



	clear width cm	in
TI-257-2108	18 x 10	7" x 4"
TI-257-2109	27 x 27	10 1/2" x 6 1/2"

Wire gauze, sterilizable



TI-257-2110
Small

TI-257-2111
Medium

TI-257-2112
Large

Fixation Disks for wire drills



TI-257-2113

Pair
Wire Strainer for Kirschner extension bows

Screw Nut Wrench for



TI-257-2114



TI-257-2115



Small Fragment Set

ART NO	#	PRODUCT NAME
TI-258-2116	01	2.0mm Drill Bit,quick coupling,125mm,2ea.
TI-258-2117	02	2.5mm Drill Bit,quick coupling,110mm,2ea.
TI-258-2118	03	2.7mm Drill Bit,quick coupling,100mm,2ea.
TI-258-2119	04	3.5mm Drill Bit,quick coupling,110mm,2ea.
TI-258-2120	05	Countersink,for 3.5mm Cortex and 4.0mm Cancellous Bone Screws
TI-258-2121	06	Tap for 2.7mm Cortex Screws
TI-258-2122	07	Tap for 3.5mm Cortex Screws
TI-258-2123	08	Tap for 4.0mm Cancellous Bone Screws
TI-258-2124	09	Handle,with quick coupling
TI-258-2125	10	T Handle,with quick coupling
TI-258-2126	11	2.0mm Parallel Drill Guide and Drill Sleeve
TI-258-2127	12	3.5mm/2.5mm Insert Drill Sleeve
TI-258-2128	13	Small Hexagonal Screwdriver with Holding Sleeve
TI-258-2129	14	Small Hexagonal Screwdriver Shaft
TI-258-2130	15	Depth Gauge for 2.7mm and 3.5mm cortex, and 4.0mm Cancellous Bone Screws
TI-258-2131	16	Screw Forceps
TI-258-2132	17	2.7mm Universal Drill Guide
TI-258-2133	18	3.5mm Universal Drill Guide
TI-258-2134	19	Bending Iron for 2.7mm and 3.5mm Plates
TI-258-2135	20	Bending Iron for 2.7mm and 3.5mm Plates
TI-258-2136	21	1.25mm Kirschner Wire,150mm,trocar point (10/pkg)
TI-258-2137	22	2.0mm Kirschner Wire,150mm,trocar point (10/pkg)
TI-258-2138	23	2.7mm DCP Drill Guide,neutral and load
TI-258-2139	24	3.5mm DCP Drill Guide,neutral and load

Large Fragment Set

ART NO	#	PRODUCT NAME
TI-258-2140	01	3.2mm Drill Bit,quick Coupling,195mm
TI-258-2141	02	4.0mm Drill Bit,quick Coupling,197mm
TI-258-2142	03	4.5mm Drill Bit,quick Coupling,145mm
TI-258-2143	04	5.5mm Drill Bit,quick Coupling,197mm
TI-258-2144	05	Countersink,for 4.5mm Cortex and Screws
TI-258-2145	06	T-Handle with quick Coupling
TI-258-2146	07	Tap for 4.5mm Cortex and 4.5mm Shaft Screws, 180mm/110mm tap depth
TI-258-2147	08	Tap for 5.5mm Cortex and 197mm/100mm tap depth
TI-258-2148	09	Tap for 6.5mm Cancellous Screws, 197mm/150mm Calibration
TI-258-2149	10	4.5mm/3.2mm Double Drill Sleeve
TI-258-2150	11	5.5mm/4.0mm Double Drill Sleeve
TI-258-2151	12	Holding Sleeve
TI-258-2152	13	Large Hexagonal Screwdriver Shaft
TI-258-2153	14	Large Hexagonal Screwdriver
TI-258-2154	15	Depth Gauge, for large Screws
TI-258-2155	16	Articulated Tension Device
TI-258-2156	17	Ratchet Wrench, 11mm Width across flats
TI-258-2157	18	5.5mm Universal Drill Guide
TI-258-2158	19	4.5mm Universal Drill Guide
TI-258-2159	20	3.2mm Drill Bit,quick Coupling, 145mm
TI-258-2160	21	4.5mm Drill Bit,quick Coupling, 145mm



Osteotome(Straight)

- TI-259-2161 = 6 (Blade width) 240 mm (Length)
- TI-259-2162 = 8 (Blade width) 240 mm (Length)
- TI-259-2163 = 10 (Blade width) 240 mm (Length)
- TI-259-2164 = 12 (Blade width) 240 mm (Length)
- TI-259-2165 = 15 (Blade width) 240 mm (Length)
- TI-259-2166 = 20 (Blade width) 240 mm (Length)
- TI-259-2167 = 25 (Blade width) 240 mm (Length)
- TI-259-2168 = 30 mm (Blade width) 240 mm (Length)



Bone Hammer

- TI-259-2193 = 50 (Weight)
- TI-259-2194 = 140 (Weight)
- TI-259-2195 = 270 (Weight)
- TI-259-2196 = 350 (Weight)
- TI-259-2197 = 450g (Weight)



Osteotome(Curved)

- TI-259-2169 = 6 (Blade width) 240 mm (Length)
- TI-259-2170 = 8 (Blade width) 240 mm (Length)
- TI-259-2171 = 10 (Blade width) 240 mm (Length)
- TI-259-2172 = 12 (Blade width) 240 mm (Length)
- TI-259-2173 = 15 (Blade width) 240 mm (Length)
- TI-259-2174 = 20 (Blade width) 240 mm (Length)
- TI-259-2175 = 25 (Blade width) 240 mm (Length)
- TI-259-2176 = 30 mm (Blade width) 240 mm (Length)



Periosteal Elevator

- TI-259-2198 = 9 (Blade width) 180 mm (Length)
- TI-259-2199 = 12 (Blade width) 180 mm (Length)
- TI-259-2200 = 15 (Blade width) 180 mm (Length)
- TI-259-2201 = 10 (Blade width) 240 mm (Length)
- TI-259-2202 = 15 (Blade width) 240 mm (Length)
- TI-259-2203 = 20 (Blade width) 240 mm (Length)



Double-Sided Osteotome

- TI-259-2177 = 6 (Blade width) 300 mm (Length)
- TI-259-2178 = 8 (Blade width) 300 mm (Length)
- TI-259-2179 = 10 (Blade width) 300 mm (Length)
- TI-259-2180 = 12 (Blade width) 300 mm (Length)
- TI-259-2181 = 15 (Blade width) 300 mm (Length)
- TI-259-2182 = 20 (Blade width) 300 mm (Length)
- TI-259-2183 = 25 (Blade width) 300 mm (Length)
- TI-259-2184 = 30 mm (Blade width) 300 mm (Length)



Bending Spanner

- TI-259-2204 = 240 mm (Length)



Bone Flat Chisels

- TI-259-2185 = 6 (Blade width) 200 mm (Length)
- TI-259-2186 = 9 (Blade width) 200 mm (Length)
- TI-259-2187 = 12 mm (Blade width) 200 mm (Length)



Spinal Gouges

- TI-259-2188 = 3 (Blade width) 200 mm (Length)
- TI-259-2189 = 4 (Blade width) 200 mm (Length)
- TI-259-2190 = 6 (Blade width) 200 mm (Length)
- TI-259-2191 = 8 (Blade width) 200 mm (Length)
- TI-259-2192 = 12 mm (Blade width) 200 mm (Length)



Double-use Guide Drill

- TI-259-2205 = 2.5 mm (Drill Bit Diam)
- TI-259-2206 = 3.2 mm (Drill Bit Diam)
- Neutral & Load Bearing Type



Depth Gauges

- TI-260-2207 = 30 (Gaugin Depth)
- TI-260-2208 = 60 (Gaugin Depth)
- TI-260-2209 = 90 (Gaugin Depth)
- TI-260-2210 = 100 mm (Gaugin Depth)



Tap(T-type handle)

- TI-260-2219 = HA2.0mm (Diam) 160 mm (Length)
- TI-260-2220 = HA3.5mm, HB3.5mm (Diam) 160 mm (Length)
- TI-260-2221 = HA4mm, HB4mm(Diam) 180 mm (Length)
- TI-260-2222 = HA4.5mm, HB4.5mm (Diam) 180 mm (Length)



Countersink Drill

- TI-260-2211 = 6mm (Reamer Diam) 180mm (Length)
- TI-260-2212 = 8mm (Reamer Diam) 180mm (Length)



Tap(T-type handle)

- TI-260-2223 = HB6.5mm (Diam) 200mm (Length)



Double-End Guider

- TI-260-2213 = (ø2.5, ø3.0) Size
- TI-260-2214 = (ø3.2, ø4.5) Size
- TI-260-2215 = (ø4.5, ø6.5) Size



Bone Pry

- TI-260-2224 = 230mm (Length)
- Size: 10mm



Broken Nail Hollow Saw

- TI-260-2216 = 8 mm (Inner Diam) 160 mm (Length)
- TI-260-2217 = 7 mm (Inner Diam) 160 mm (Length)
- TI-260-2218 = 6 mm (Inner Diam) 160 mm (Length)



Bone Curette

- TI-260-2225 = 3 (Blade Width)
- TI-260-2226 = 4 (Blade Width)
- TI-260-2227 = 5 (Blade Width)
- TI-260-2228 = 6 (Blade Width)
- TI-260-2229 = 7mm (Blade Width)

Straight, left bend, right bend, front bend



Nerve Detached

- TI-261-2230 = 3 (Double Ended width) 240mm (Length)
- TI-261-2231 = 5mm (Double Ended width) 240mm (Length)
- TI-261-2232 = 5mm (Dissector width)

with Blend Hook on the other, Length 240mm



Screw Driver

- Slotted Point Large, Small
- TI-261-2237 = SW3.5 (Inner Hexagonal) 200mm (Length)
- TI-261-2238 = SW2.5 (Inner Hexagonal) 200mm (Length)



Retractor

- TI-261-2233 = 18mm (Size)
- TI-261-2234 = 42mm (Size)



Safety Screw Driver

- Slotted Point Large, Small
- TI-260-2239 = SW3.5 (Inner Hexagonal)
- TI-260-2240 = SW2.5 (Inner Hexagonal)



Bone File Osteotribe

- TI-261-2235
- Round Osteotribe
- Edge Osteotribe



Britton Safety Screwdriver

- TI-261-2241 = (SW2.5e)
- TI-261-2242 = (SW3.5e)
- Size: Flat-head (Small, Large)



Bone File Osteotribe

- TI-261-2236
- Round Osteotribe
- Flat Osteotribe



Broken Nail Extractor

- TI-261-2243
- Size: Large, Small



Self-Centering Bone Holding Forceps

TI-262-2244 = 180mm (Length)
TI-262-2245 = 260mm (Length)
(Large size), (Small size)



Reduction Forceps

TI-262-2249 = 160mm (Length)
TI-262-2250 = 220mm (Length)
Size: Large, small



Talc Triangle Self-Centering Bone Holding Forceps

TI-262-2246 = 250mm (Length)



Reduction Forceps with Points

TI-262-2251 = 140mm (Length)
TI-262-2252 = 200mm (Length)
Size: Large, small



Talc Bone Holding Forceps with Guide

TI-262-2247 = 230mm (Length)
Size: Large, medium, small



Double Joint Bone Scissors
(Straight Curved)

TI-262-2253 = 160mm (Length)
TI-262-2254 = 180mm (Length)
TI-262-2255 = 230mm (Length)
TI-262-2256 = 270mm (Length)



Bone Holding Clamps

TI-262-2248
Size: Large, medium, small



Double Joint Outrigger Scissors

TI-262-2257 = 260mm (Length)



Talc Angle Rongeur Scissors
TI-263-2258 = 200mm (Length)



Bone Rongeurs (Angular)
TI-263-2267 = 3mm (Blade Width) 220mm (Length)
TI-263-2268 = 5mm (Blade Width) 220mm (Length)
TI-263-2269 = 6mm (Blade Width) 220mm (Length)



Double Action Bone Rongeurs (Slightly Curved)
TI-263-2259 = 2-3mm (Blade Width) 160mm (Length)
TI-263-2260 = 2-3mm (Blade Width) 180mm (Length)
TI-263-2261 = 3-4mm (Blade Width) 220mm (Length)



Laminectomy Rongeurs (Angular)
TBI-263-2270 = 2mm (Blade Width) 160mm (Stem Length)
TI-263-2271 = 2.5mm (Blade Width) 160mm (Stem Length)
TI-263-2272 = 4.5mm (Blade Width) 160mm (Stem Length)
(Blade Mouth Angle) 90°, 110°, 130°



Double Action Bone Rongeurs (Pointed Curved)
TI-263-2262 = 2mm (Blade Width) 180mm (Length)
TI-263-2263 = 3mm (Blade Width) 180mm (Length)
TI-263-2264 = 3mm (Blade Width) 220mm (Length)
TI-263-2265 = 4mm (Blade Width) 220mm (Length)



Germanic Laminectomy Rongeurs
TI-263-2273 = 2.0mm (Blade Width)
TI-263-2274 = 2.5mm (Blade Width)
TI-263-2275 = 3mm (Blade Width)
TI-263-2276 = 3.5mm (Blade Width)
TI-263-2277 = 4.5mm (Blade Width)
(Blade Mouth Angle) 90°, 110°, 130°
180mm, 220mm (Stem Length)



Double Action Bone Rongeurs (Straight)
TI-263-2266 = 8mm (Blade Width) 220mm (Length)



Spurling Rongeurs (Straight)
TI-263-2278 = 3, 4.5mm (Blade Width) 170mm (Length)
TI-263-2279 = 3, 4.5mm (Blade Width) 220mm (Length)



Plate Bend Forceps
TI-264-2280 = 220mm (Length)



Talc Rejection Forceps
TI-264-2285 = 160mm (Large, Length)
TI-264-2286 = 140mm (Small, Length)



Desk Type Bending Press
TI-264-2281
Desk type



Talc Bedside Traction Rack
TI-264-2287



Spurling Rongeurs (Up Angle)
TI-264-2282 = 3, 4.5mm (Blade Width) 170mm (Length)
TI-264-2283 = 3, 4.5mm (Blade Width) 220mm (Length)



Talc Blouse Rack
TI-264-2288



Wire Cutting Forceps
TI-264-2284 = 1.2mm
Maximum ranges of cutting 1.2mm diameter



Wire Pliers For Medical Application (Flat Sharp)
TI-264-2289 = 2mm
Maximum ranges of cutting 2mm diameter



Wire Cutting Forceps
TI-265-2290 = 2.5mm
Maximum ranges of cutting 2.5mm diameter



Wire Cutting Forceps
TI-265-2294 = 6mm
Maximum ranges of cutting 6mm diameter



Talc Bone Kirshner Scissors
TI-265-2291 = 2.5mm
Maximum ranges of cutting 2.5mm diameter



Talc Aseous Pin Bending Forceps
TI-265-2295
Large size, Bend Kirshner Pin Use
Small size, Bend Kirshner Pin Use



Wire Cutting Forceps
TI-265-2292 = 2mm
Maximum ranges of cutting 2mm diameter



Auto Retractors
TI-265-2296 = 200mm (Length) 40mm, 60mm (Hook Depth)

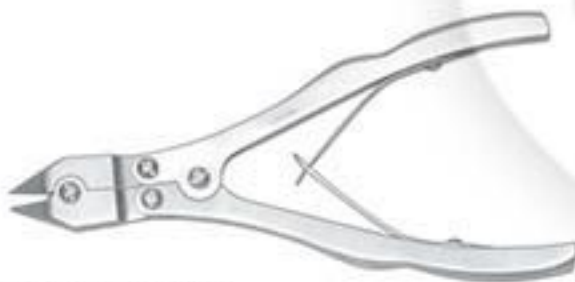

Wire Cutting Forceps
TI-265-2293



Skull Tractive Bow
TI-265-2297
Large size



Skull Tractive Bow
TI-266-2298
Size: Medium, Small



Retractor Self-Retaining Ratchet Typer
TI-266-2304 = 280mm (Length)



Kirshner Wires Traction Bow
TI-266-2299



Talc Spine Retractor Multi-Purpose
TI-266-2305 = 3x1 set



Steinman Pins Traction Bow
TI-266-2300
Size: Large, medium, small



Compression Instrument
TI-266-2306 = 240mm (Length) Hip Nail Use



Angle Finer
TI-266-2301 = 95° (Mouth Angle)
TI-266-2302 = 130° (Mouth Angle)
TI-266-2303 = 135° (Mouth Angle) Hip Nail Use



Cervical Vertebrae Trephine
TI-266-2307 = 9mm (Diam)
TI-266-2308 = 10mm (Diam)
TI-266-2309 = 11mm (Diam)
TI-266-2310 = 12mm (Diam)
TI-266-2311 = 13mm (Diam)
TI-266-2312 = 14mm (Diam)
TI-266-2313 = 15mm (Diam)
TI-266-2314 = 16mm (Diam)
Used for Cervical vertebra and lumbar vertebra



Inserter Extractor

TI-267-2315 = 200mm (Length) Hip Nail Use



Indicator Rotating Core

TI-267-2321 = 8mm	TI-267-2325 = 12mm
TI-267-2322 = 9mm	TI-267-2326 = 13mm
TI-267-2323 = 10mm	TI-267-2327 = 14mm
TI-267-2324 = 11mm	TI-267-2328 = 15mm



Combined Reamer

TI-267-2316 = Size 250mm (for DHS/DCS)



Periosteal Elevators

TI-267-2329 = 300mm (Length)
Sharp mouth, micro sharp mouth



Screw Tap

TI-267-2317 = 270mm (Length) Hip Nail Use



Nerve Root Retractors

TI-267-2330 = Size 3mm, 90° (Mouth Angle)
TI-267-2331 = Size 5mm, 135° (Mouth Angle)
TI-267-2332 = Size 7mm, 180° (Mouth Angle)



Screw Holding Forceps

TI-267-2318 = 3.5 (To Hold Dian)
TI-267-2319 = 4 (To Hold Dian)
TI-267-2320 = 4.5mm (To Hold Dian)



Muscle Retractors

TI-267-2333 = Size: Large, Small



Cervical Vertebra Retractor
TI-268-2334
Size: Large, Small



Shank Bone and Splinter Bone Retractor
TI-268-2337 Size: Bread Shape



Patella Clamp
TI-268-2335 = 190mm (Length)



Jet Wire Twister
TI-268-2338



Spinal Plate Retractor
TI-268-2336 = Size: Large, Small



Conductor Steel Tyre
TI-268-2339 = Size: Straight, Left Bend,
Right Bend, Form Band

08

ASEPSIS INSTRUMENTS



TALC INDUSTRIES
ONE STOP FOR MEDICAL EQUIPMENT



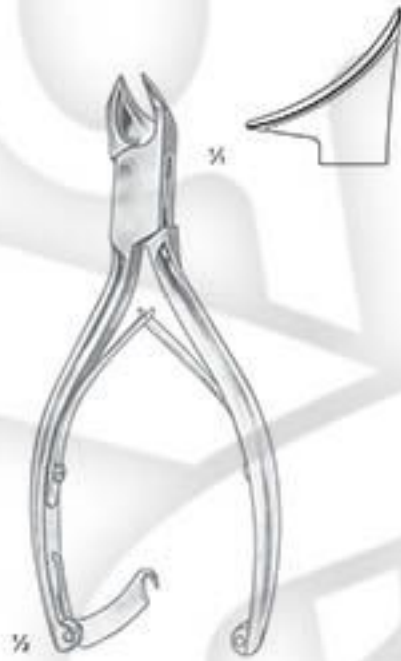

TI-269-2340
14.0 cm / 5½"



TI-269-2341 - 14.0 cm / 5½"
TI-269-2342 - 16.0 cm / 6¼"



Turnbull
TI-269-2343 - 11½ cm / 4½"
TI-269-2344 - 13.0 cm / 5"



TI-269-2345
13.0 cm / 5"



TI-270-2346
12.0 cm / 4 3/4"



TI-270-2347 - 11.0 cm / 4 1/2"
TI-270-2348 - 13.0 cm / 5"
TI-270-2349 - 15.0 cm / 6"



TI-270-2350 - 11.0 cm / 4 1/2"
TI-270-2351 - 13.0 cm / 5"



TI-270-2352
10.5 cm / 4 1/4"



Cohen
TI-270-2353
13.0 cm / 5"



Cohen
TI-270-2354
13.0 cm / 5"



TI-271-2355
20.0 cm / 8"
Iodine Forceps
of acrylic



Cheatle
TI-271-2356
27.0 cm / 10½"
Sterilizing Forceps



TI-271-2357
30.0 cm / 12"



Rogge
TI-271-2358
23.0 cm / 9"



Pye-Smith (Harrison)
TI-271-2359
30.0 cm / 12"

09

RHINOLOGY INSTRUMENTS





TI-272-2360



TI-272-2361



TI-272-2362



TI-272-2363



TI-272-2364



TI-272-2365



Goldsmith (Thudichum)



Voltolini

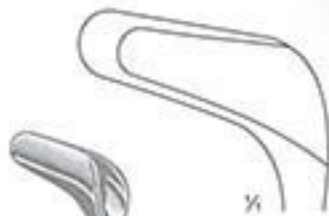

TI-272-2366
14.0 cm / 5½"

Schwarz



Hartmann-Halle
15.0 cm / 6"



TI-272-2367



TI-272-2368

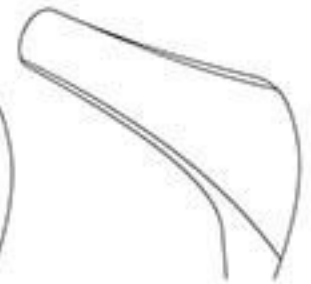

TI-272-2369

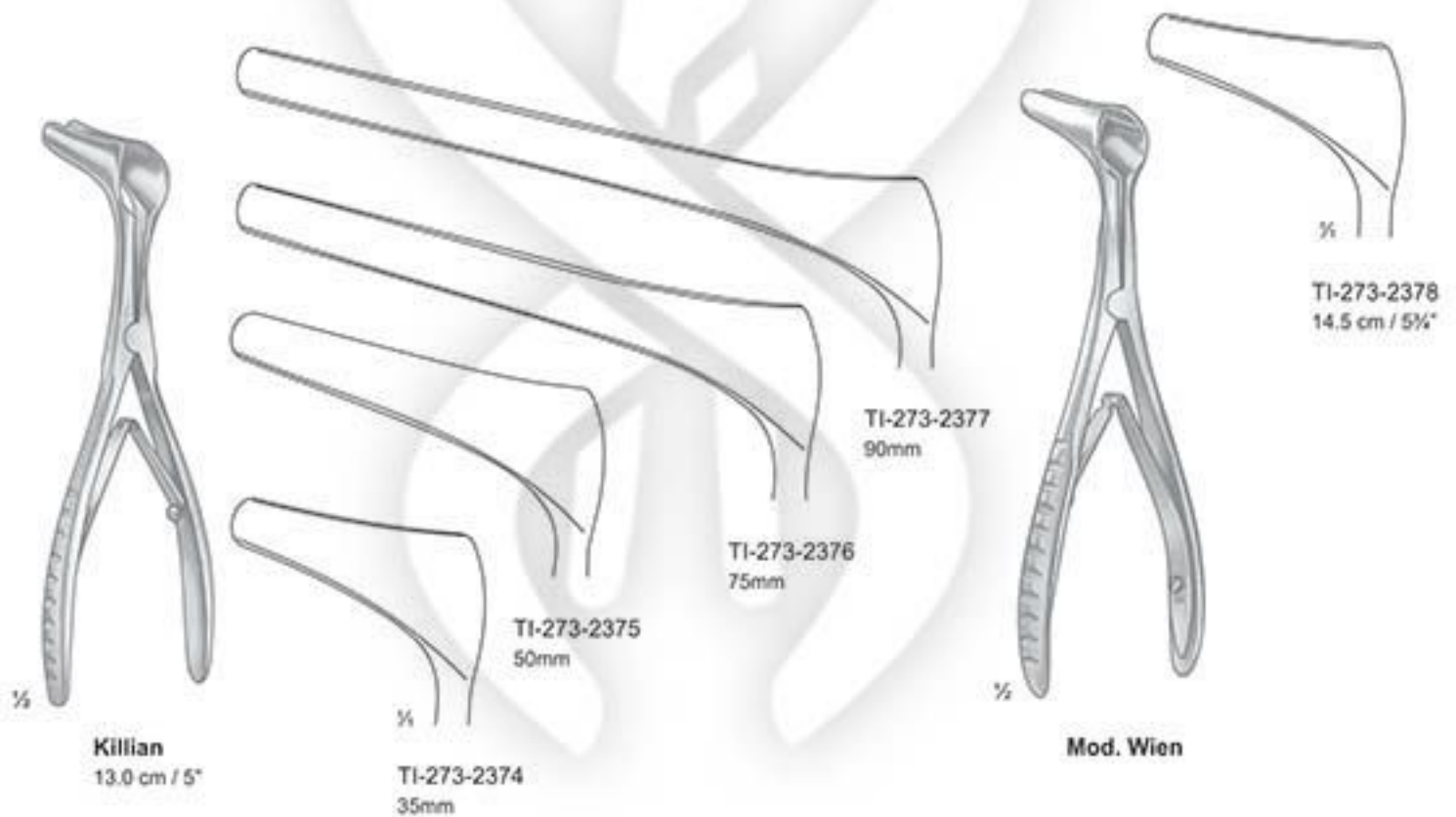
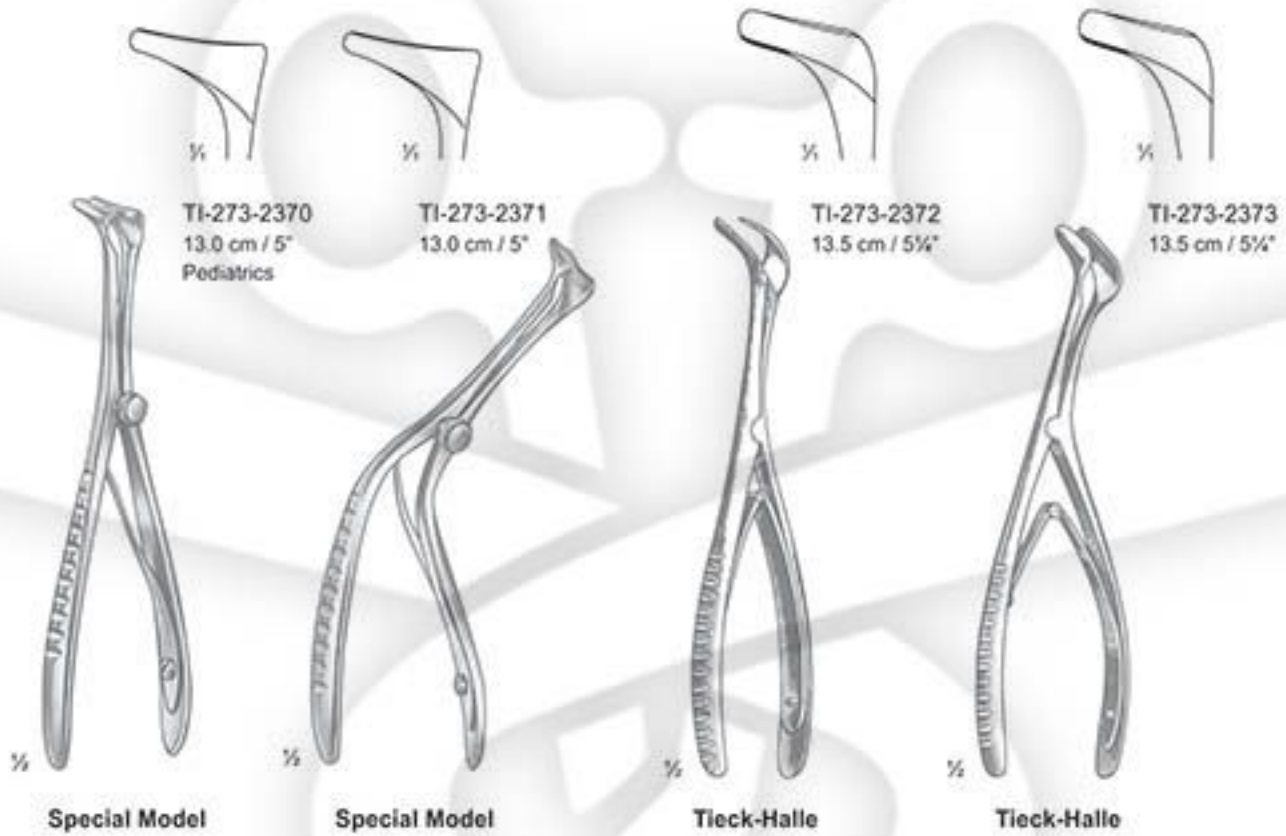



Cottle
15.0 cm / 6"

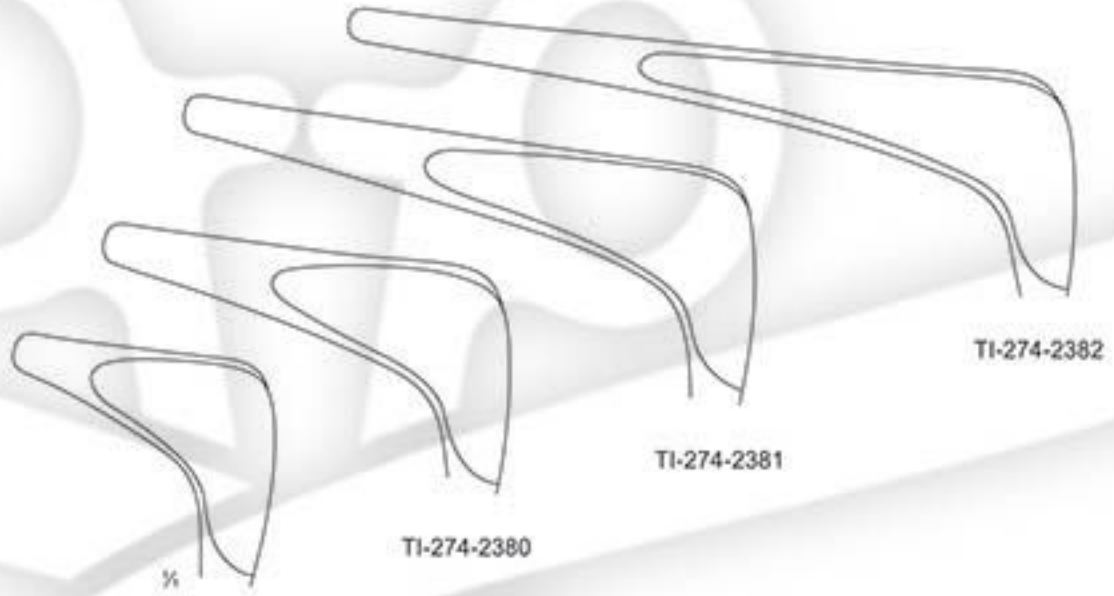

TI-274-2379

TI-274-2380

TI-274-2381

TI-274-2382



Cottle
14.0 cm / 5 1/2"

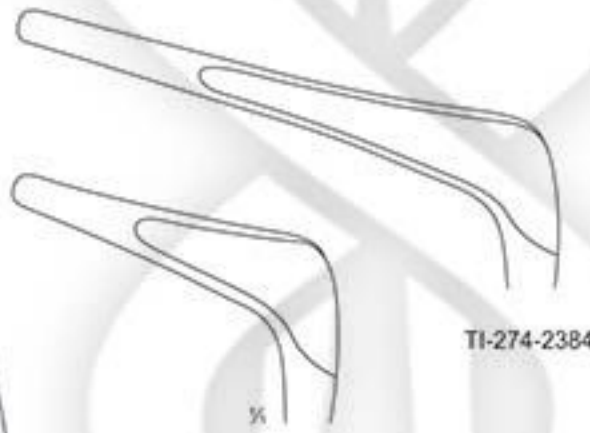

TI-274-2383

TI-274-2384

Dull black
chromium
plated



Yankauer
TI-274-2385
19.0 cm / 7 1/2"



Troeltsch
TI-275-2386
15.0 cm / 6"

Troeltsch
TI-275-2387
18.0 cm / 7"

Gruenwald (Jansen)
TI-275-2388
20.0 cm / 8"



Westmacott
TI-275-2389
20.0 cm / 8"

Lubet-Barbon
TI-275-2390
20.0 cm / 8"

Hartmann
TI-275-2391
16.0 cm / 6 1/2"

Heymann
TI-275-2392
18.0 cm / 7"



Hartmann
TI-276-2393
20.0 cm / 8"



Littauer
TI-276-2394
18.0 cm / 7"



Killian
TI-276-2395
17.0 cm / 6 1/2"



TI-276-2397

TI-276-2398

TI-276-2399



TI-276-2400



Quire
TI-276-2396
12.0 cm / 4 1/2"



Heymann
18.0 cm / 7"

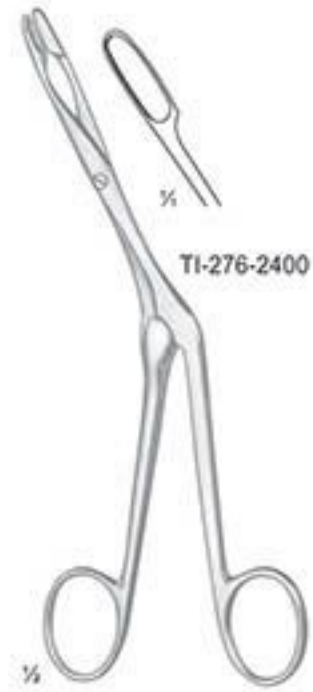

Knight
18.0 cm / 7"

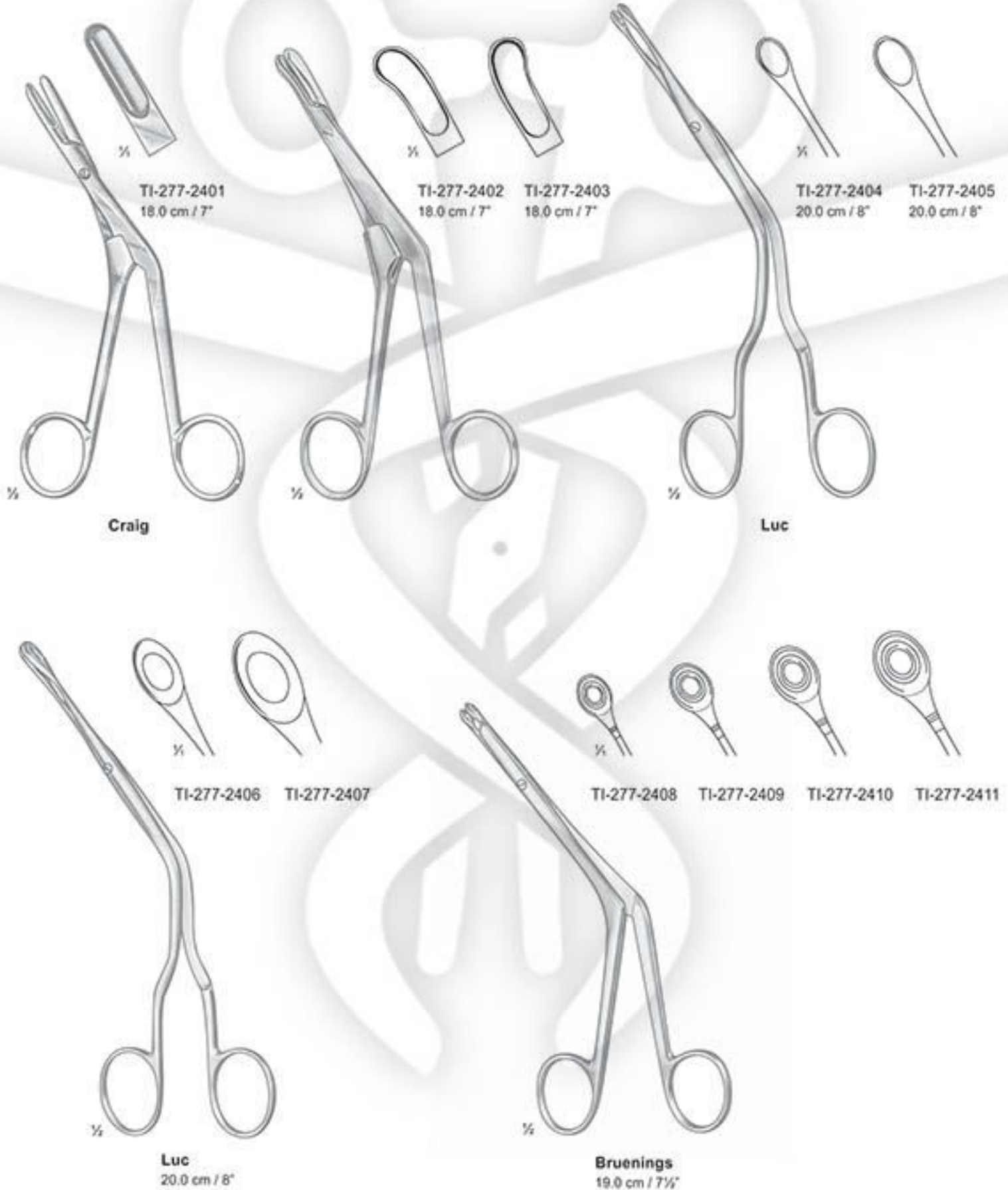

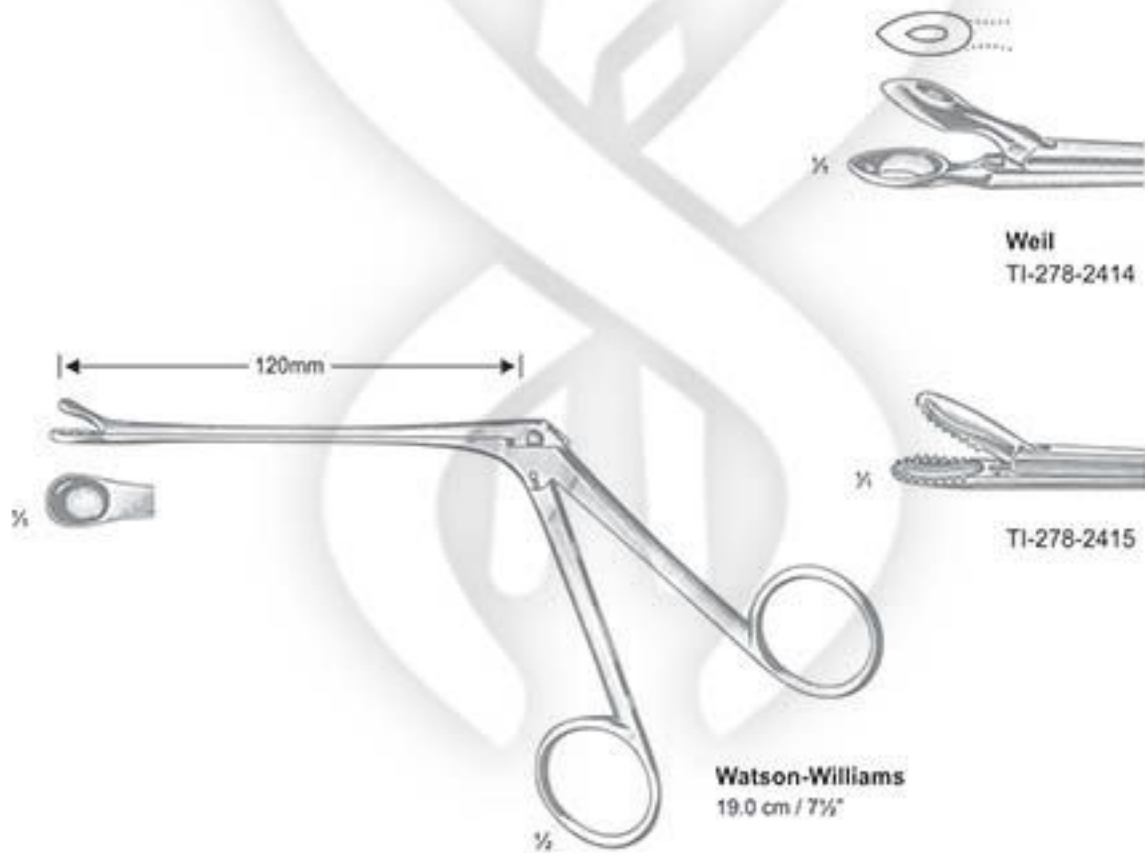
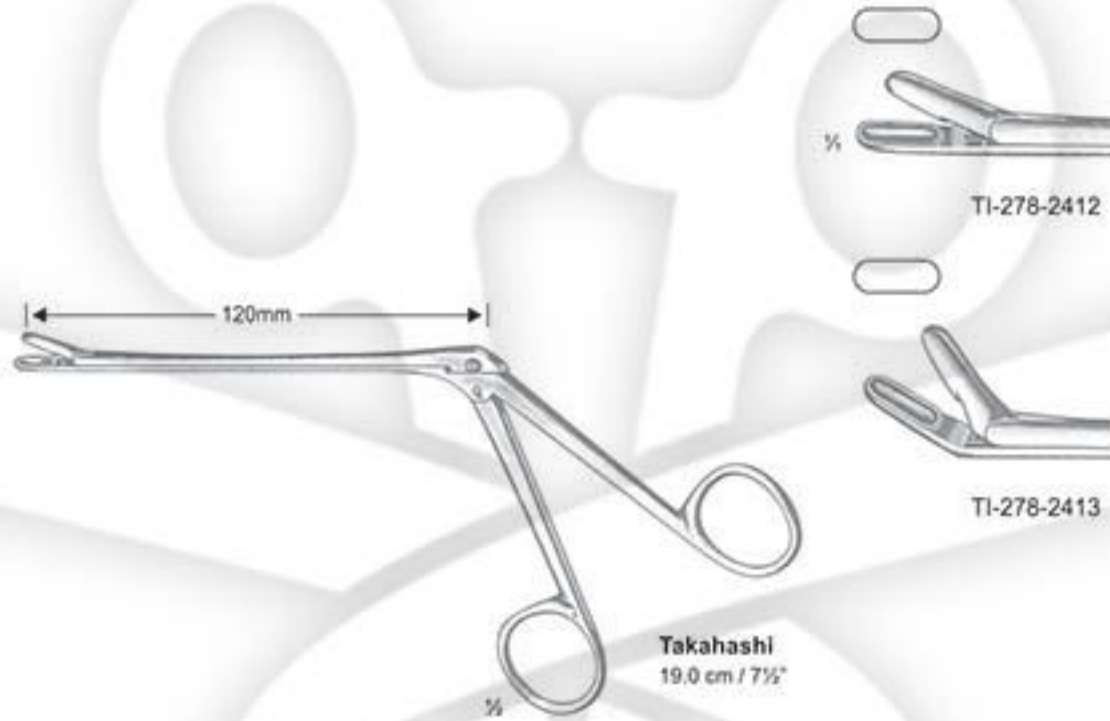



without neck



TI-279-2416



TI-279-2417



TI-279-2418



TI-279-2419



TI-279-2420



with neck



TI-279-2421



TI-279-2422



TI-279-2423



TI-279-2424



TI-279-2425

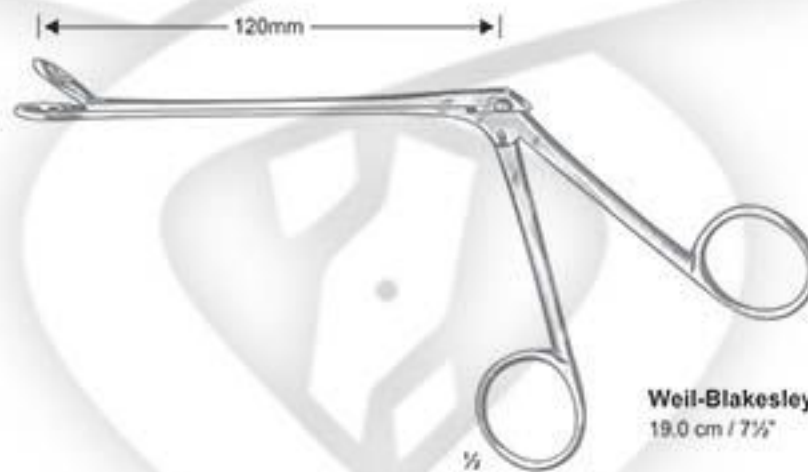

Weil-Blakesley
19.0 cm / 7 1/2"



TI-279-2426

TI-279-2427

Struycken
19.0 cm / 7 1/2"

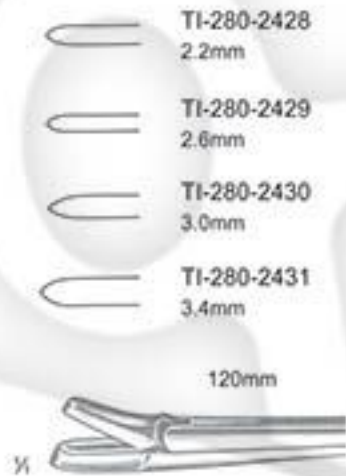

TI-280-2432

TI-280-2433

TI-280-2434

TI-280-2435



Myles
19.0 cm / 7½"



19.0 cm / 7½"

TI-280-2436
5.0mm

TI-280-2437
7.0mm

TI-280-2438
9.0mm

TI-280-2439
11.0mm



Hartmann
19.0 cm / 7½"

TI-280-2440



Schmeden
19.0 cm / 7½"

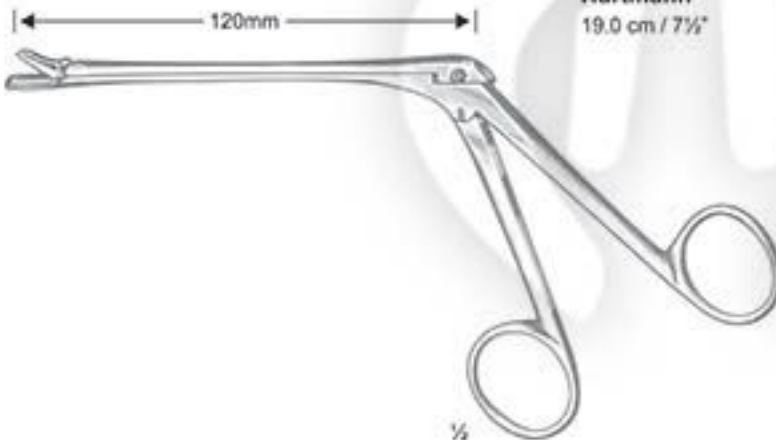



Jansen-Struycken
TI-281-2441
19.0 cm / 7½"



Middleton-Jansen
TI-281-2442
19.0 cm / 7½"



Middleton-Jansen
TI-281-2443
19.0 cm / 7½"



TI-282-2447

Caplan
TI-282-2444
20.0 cm / 8"

Septum scissors serrated

Killian
TI-282-2445
21.0 cm / 8½"

Septum scissors serrated

Rubin
TI-282-2446
21.0 cm / 8½"

Septum morselizer

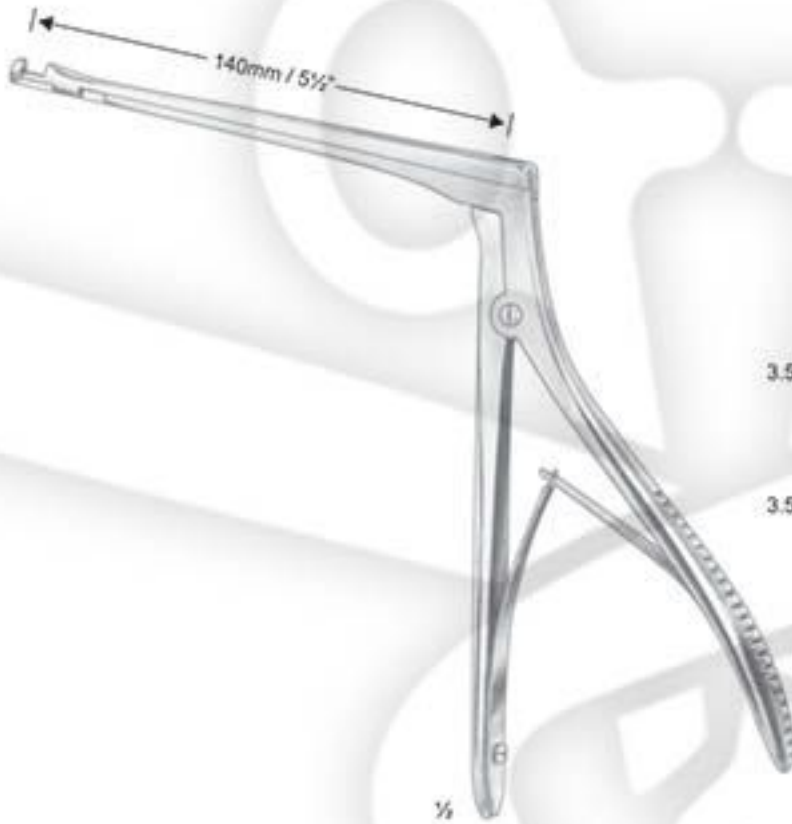

4 x 4mm  Hajek
TI-283-2448

4 x 4mm  Hajek
TI-283-2449

3.5 x 3.5mm  Hajek-Kofler
TI-283-2450

3.5 x 3.5mm  Hajek-Kofler
TI-283-2451

3 x 5mm  TI-283-2452

3 x 5mm  TI-283-2453

5 x 5mm  TI-283-2454

5 x 5mm  TI-283-2455

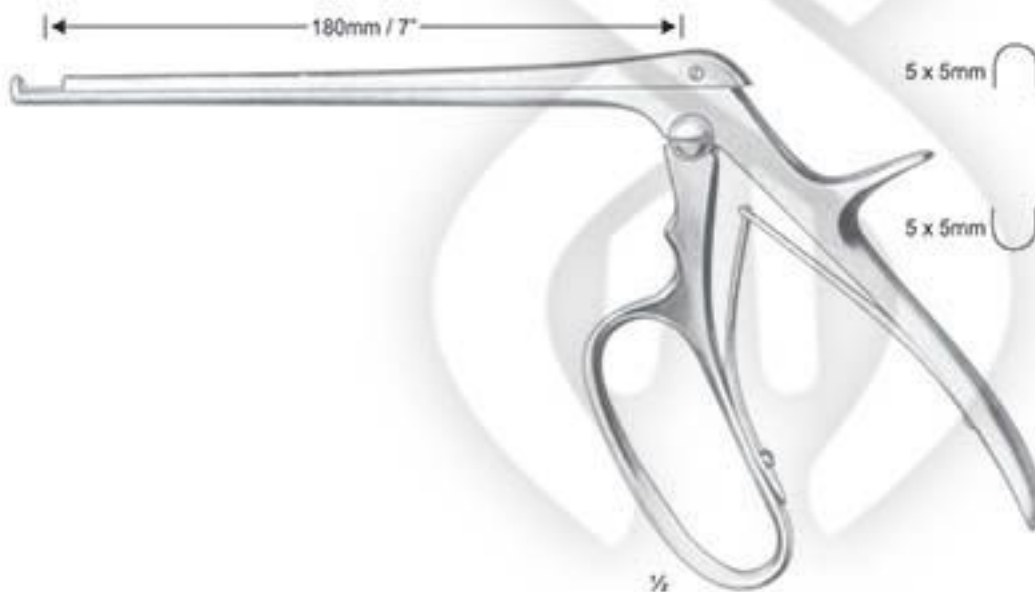

Ferris-Smith-Kerrison
18.0 cm / 7" shaft

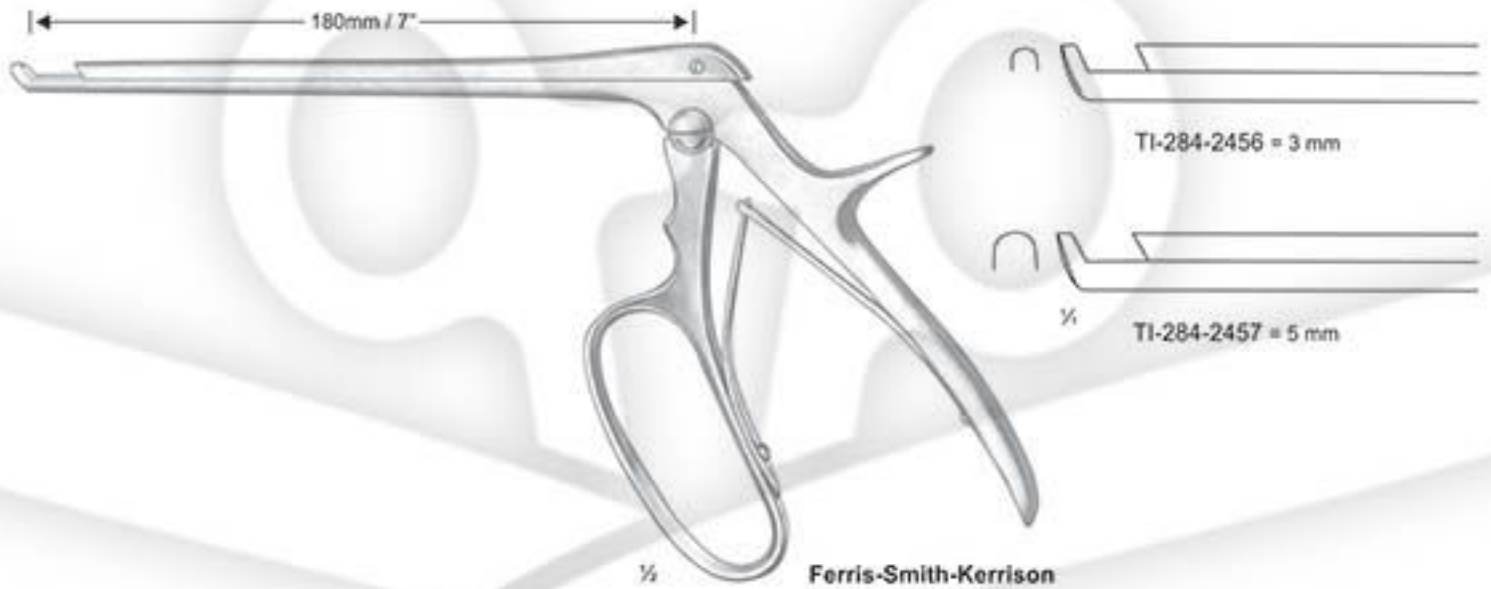

**Ferris-Smith-Kerrison
(Cloward Harper)**
18.0 cm / 7" shaft

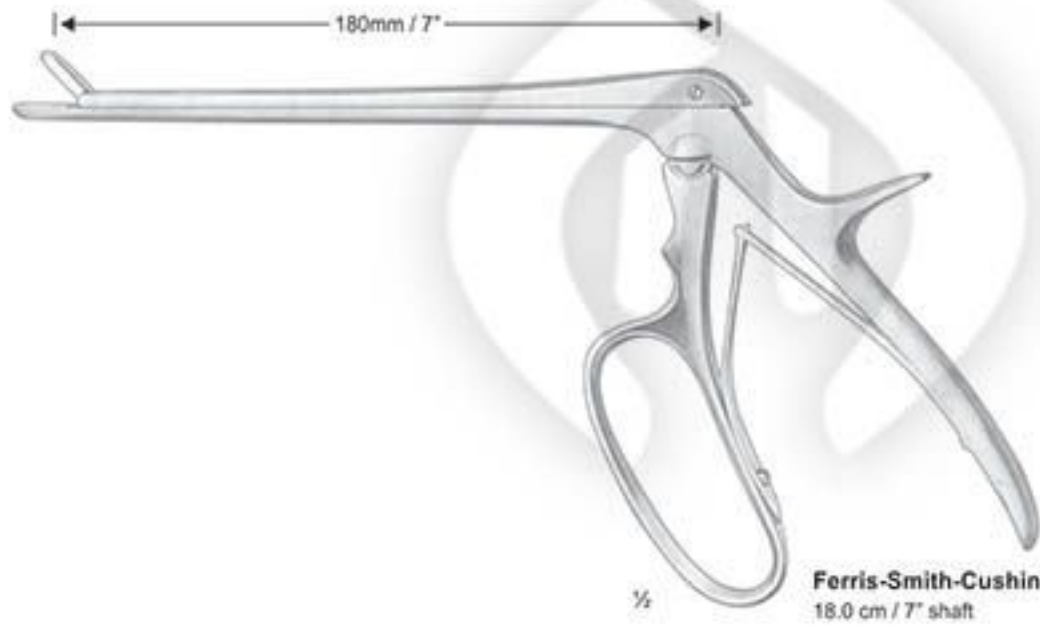
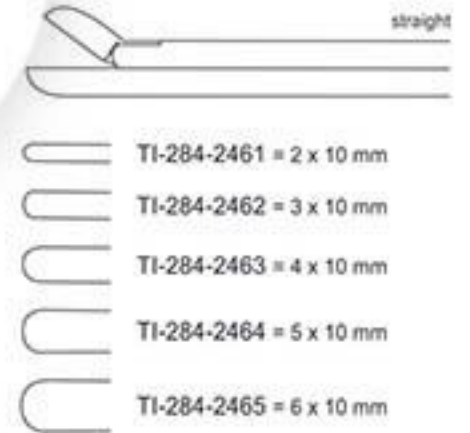
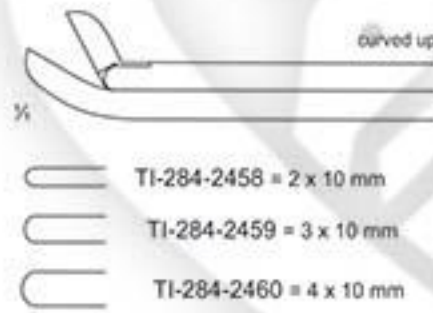

Ferris-Smith-Cushing
18.0 cm / 7" shaft





Hajek-Claus
TI-285-2469
20.0 cm / 8"



Kerrison
20.0 cm / 8"

4 x 4 mm  TI-285-2470 = 4 mm

5 x 5 mm  TI-285-2471 = 5 mm

6 x 6 mm  TI-285-2472 = 6 mm

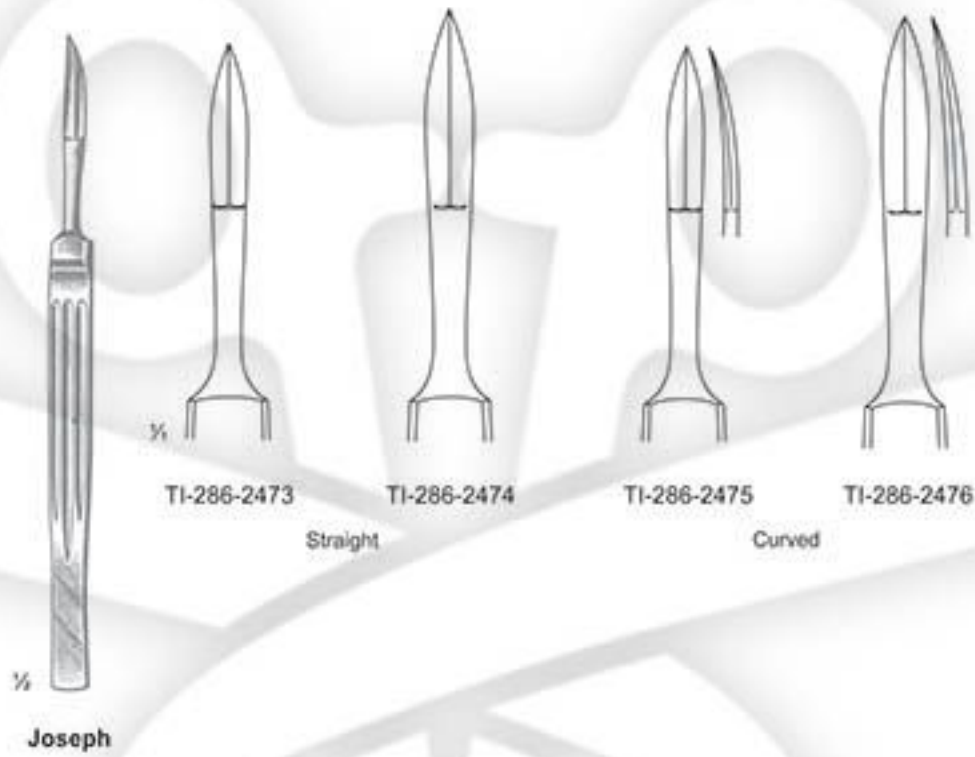

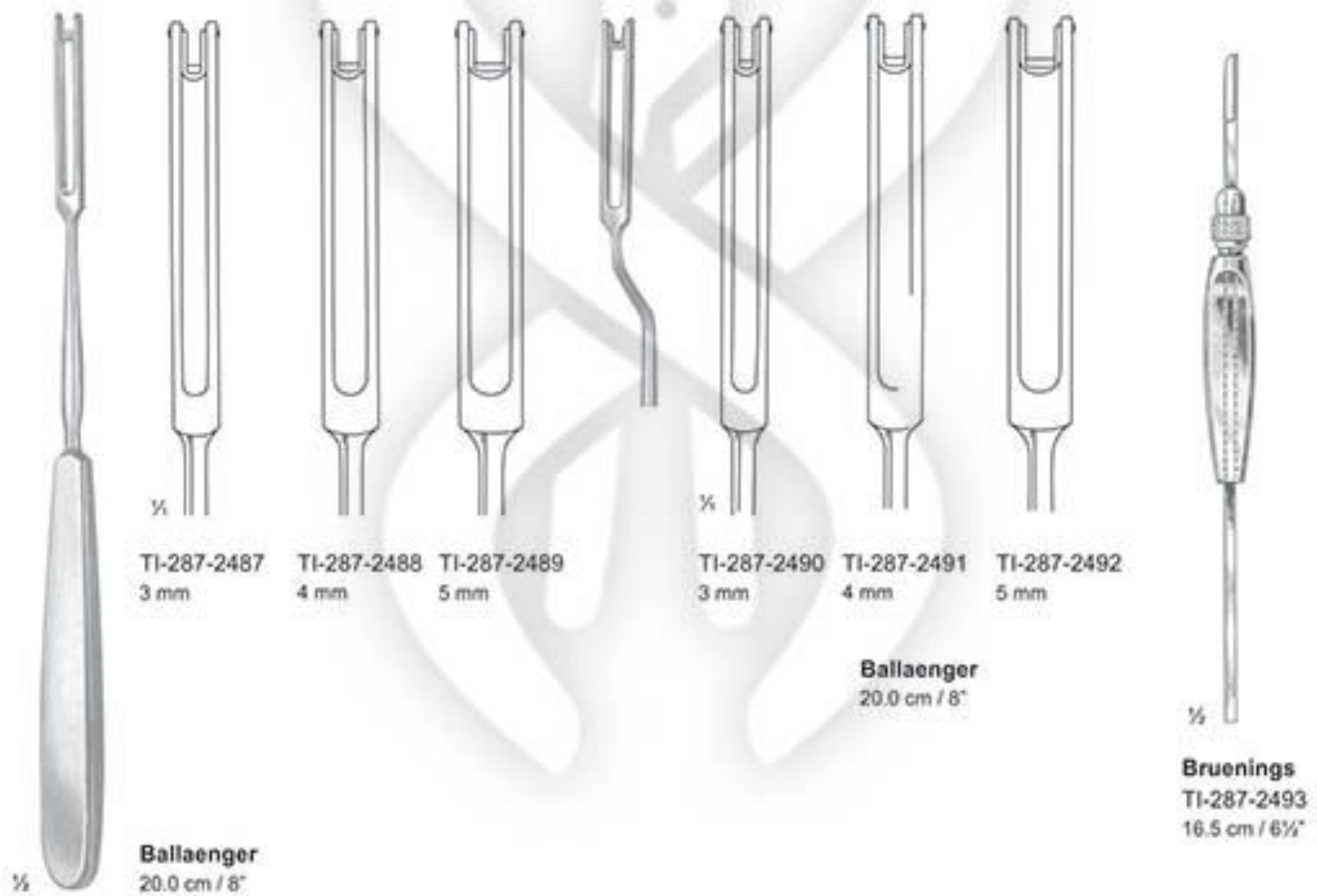



TI-288-2494
4 mm

Mckenty



TI-288-2495
5 mm



TI-288-2496
16.5 cm / 6 1/2"

Halle



TI-288-2497
16.5 cm / 6 1/2"

Joseph



Freer
TI-288-2498
19.0 cm / 7 1/2"

sharp



Freer
TI-288-2499
19.0 cm / 7 1/2"

blunt



Freer
TI-288-2500
18.0 cm / 7"

sharp-blunt



Sharp

Blunt

Freer
TI-288-2501
20.5 cm / 8"

Blunt

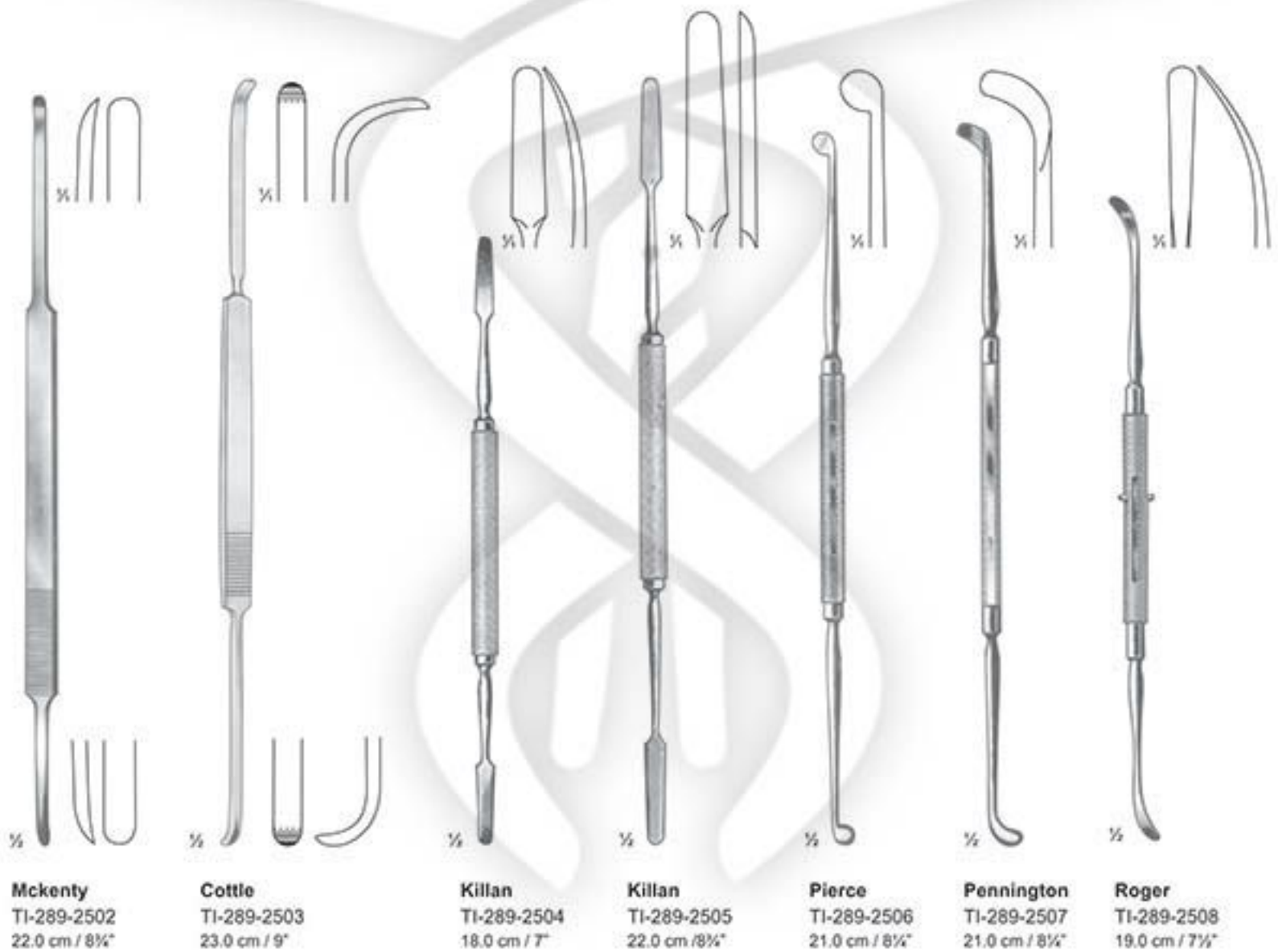

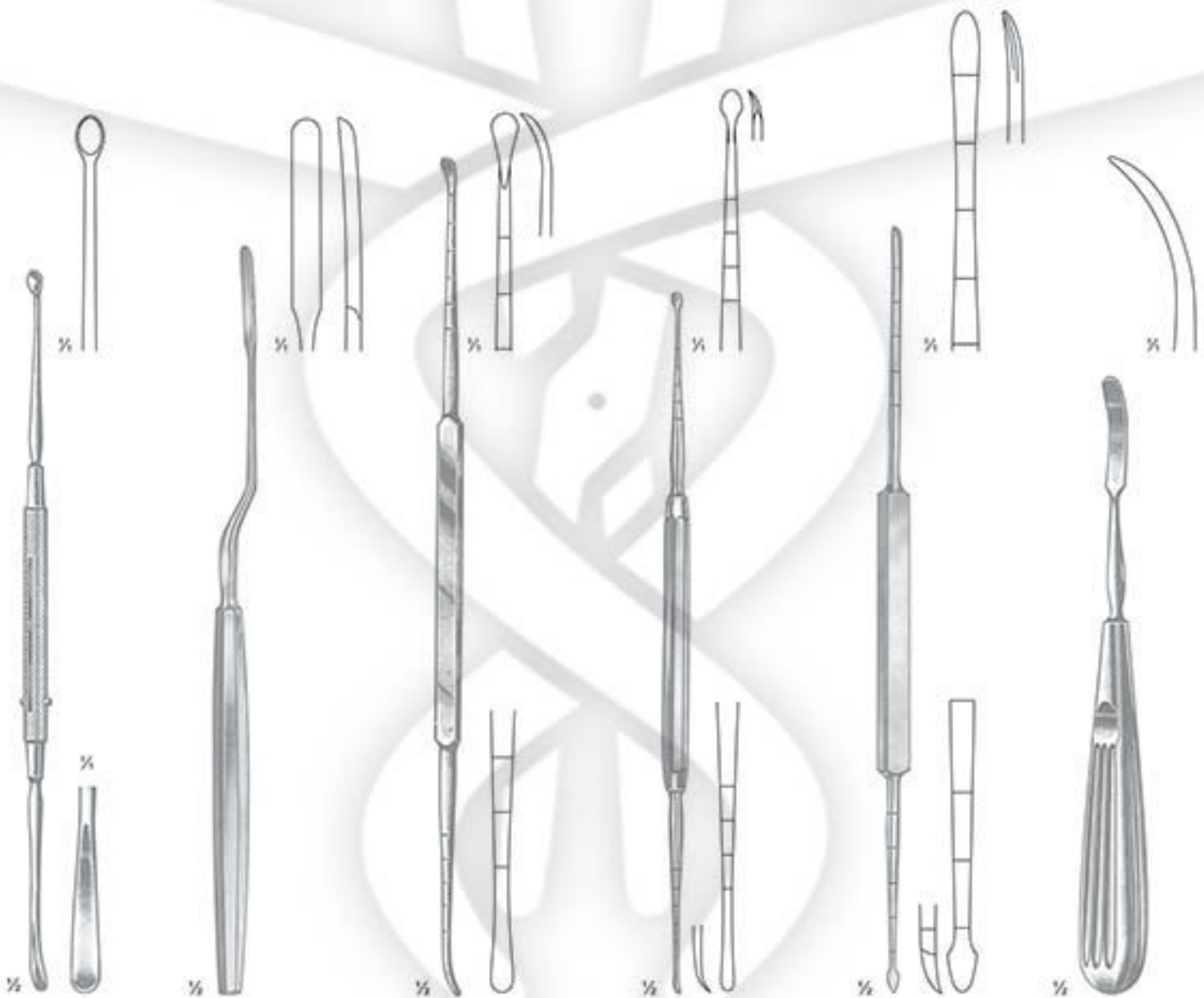

Carter
TI-290-2509
21.0 cm / 8 1/4"

Joseph-Masing
TI-290-2510
22.0 cm / 8 1/2"

Cottle
TI-290-2511
22.0 cm / 8 1/2"

Masing
TI-290-2512
21.0 cm / 8 1/4"

Cottle
TI-290-2513
21.0 cm / 8 1/4"

Joseph
TI-290-2514
16.0 cm / 6 1/4"

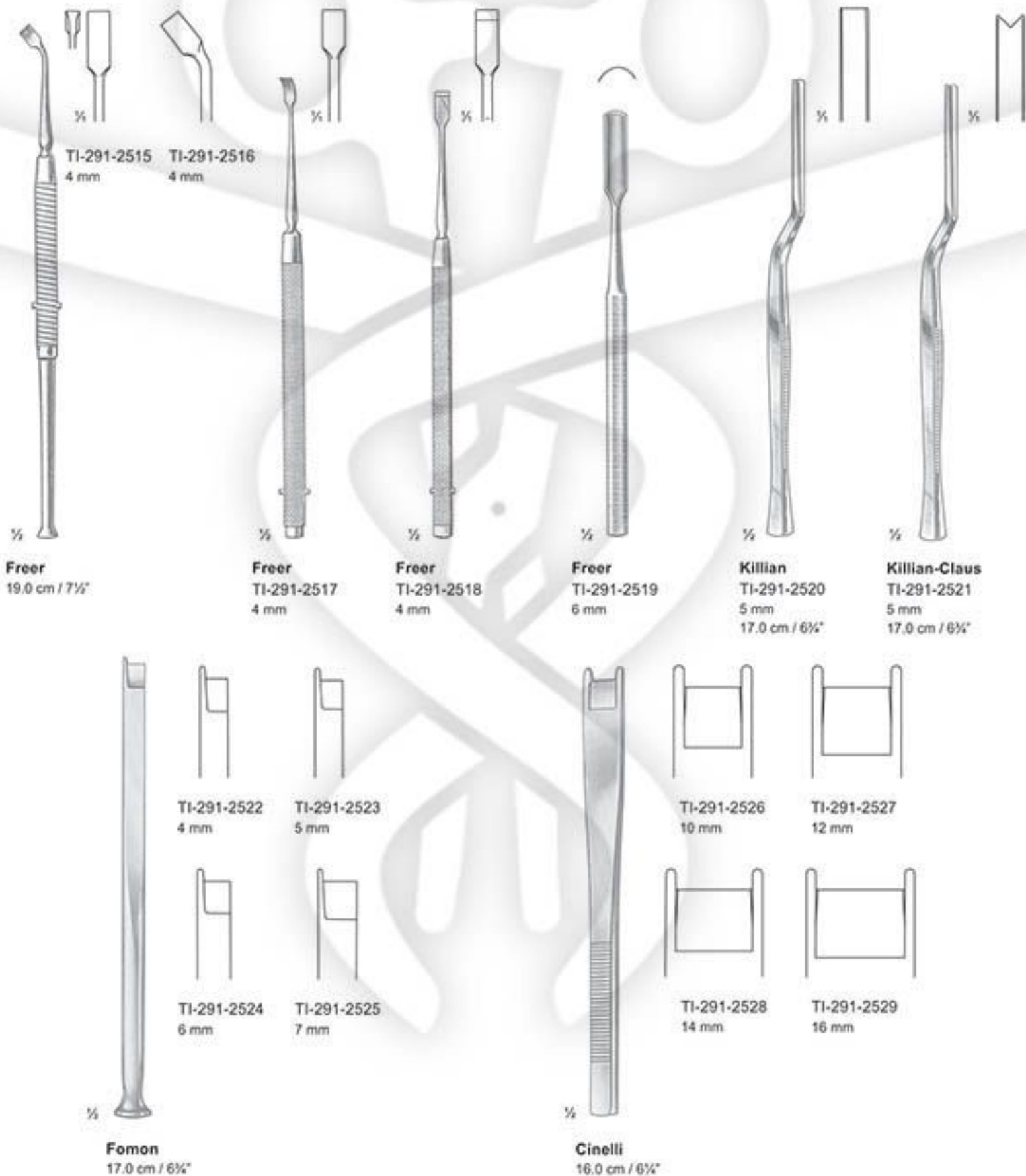



TI-292-2530
4 mm



TI-292-2531
7 mm



TI-292-2532
9 mm



TI-292-2533
12 mm

Cottle
18.0 cm / 7"



TI-292-2534

Cottle
18.0 cm / 7"



Cottle
18.0 cm / 7"



TI-292-2535
4 mm



TI-292-2536
7 mm



TI-292-2537
9 mm



TI-292-2538
12 mm



TI-292-2539
6 mm

Cottle
18.0 cm / 7"



TI-292-2540
16 mm

Cottle
18.0 cm / 7"



TI-292-2541
16 mm

Cottle
18.0 cm / 7"

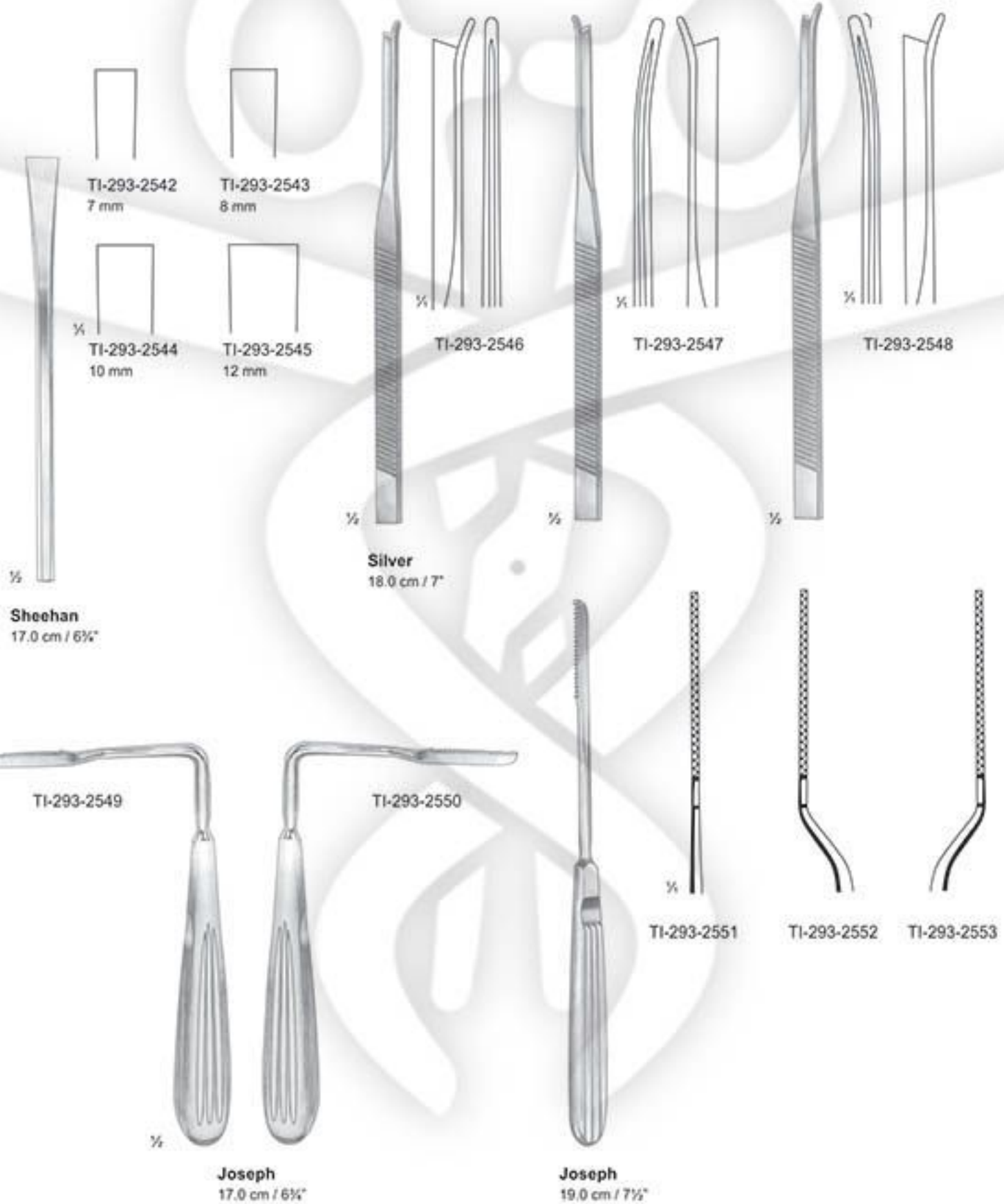

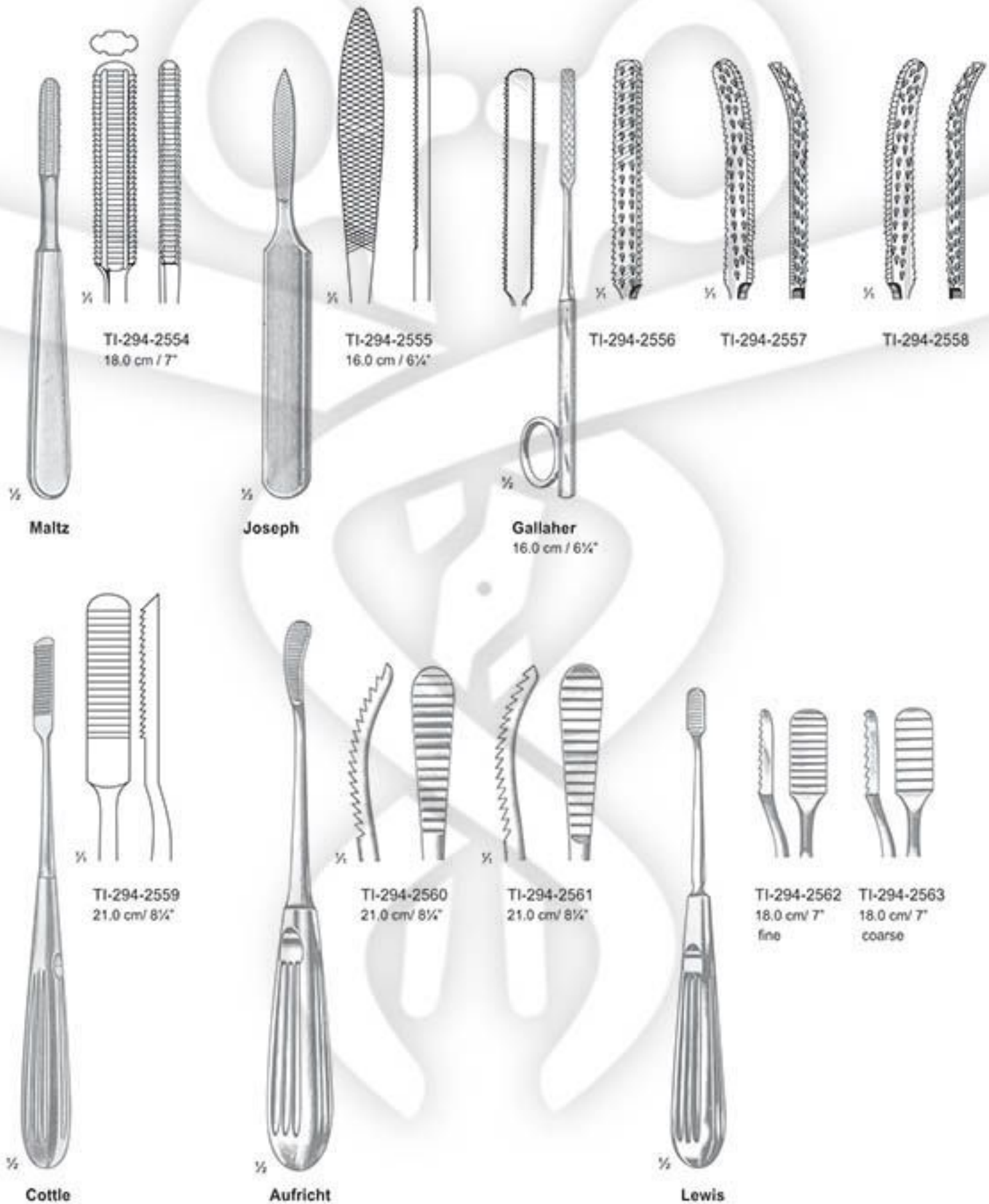

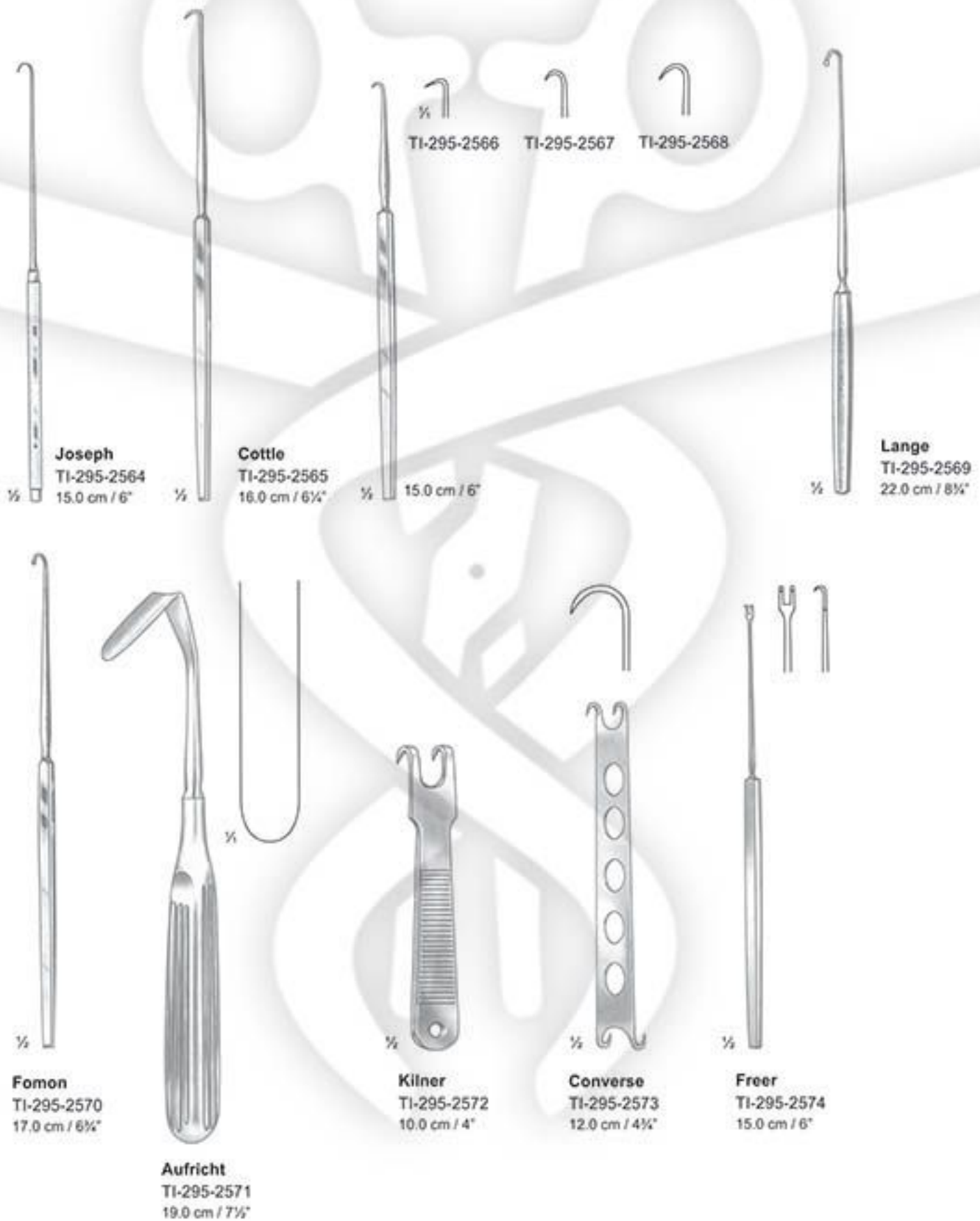

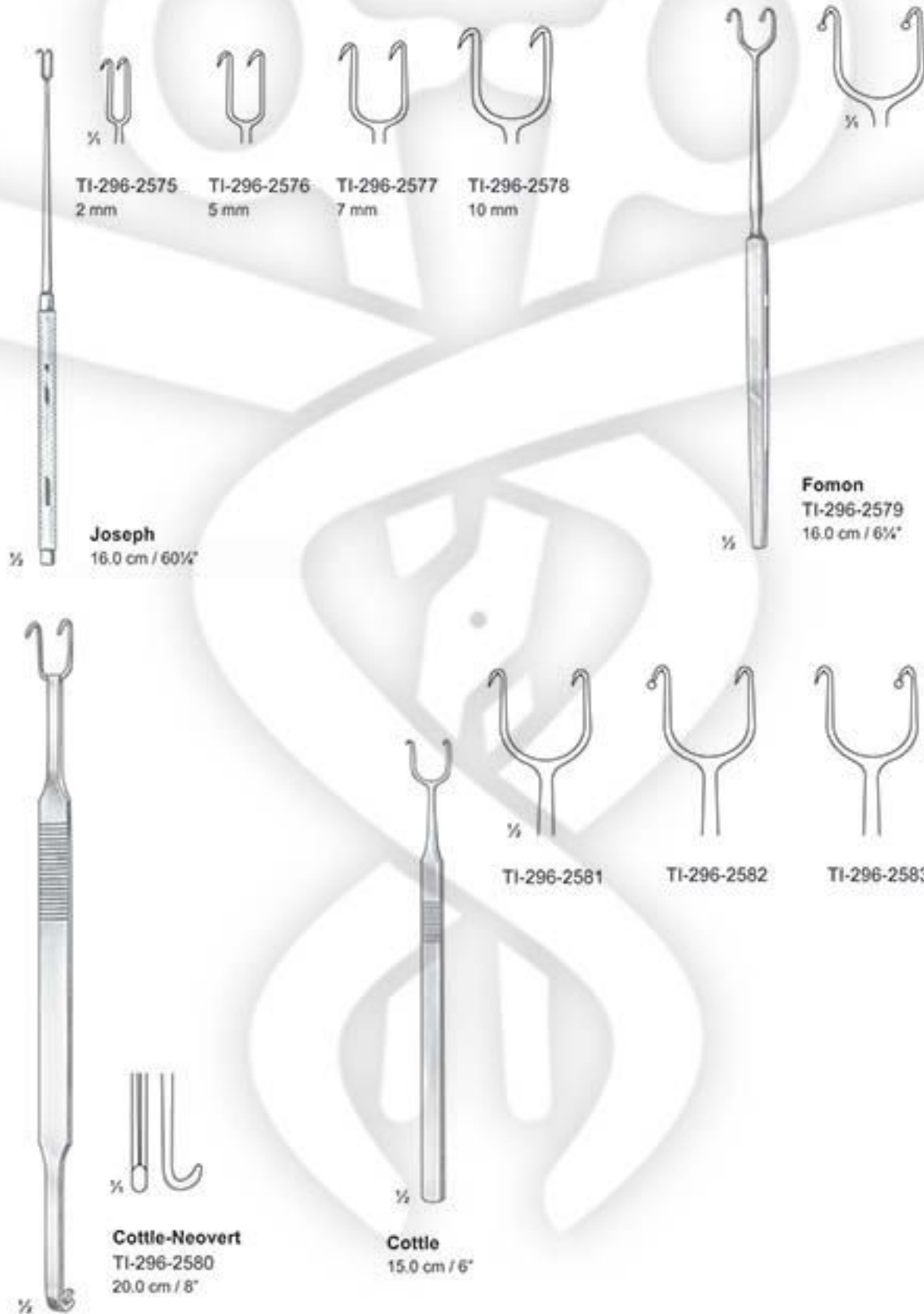



Cottle
TI-297-2584
14.0 cm / 5½"



Neivert
TI-297-2585
16.0 cm / 6¼"



Cottle
TI-297-2586
15.0 cm / 6"



Cottle
TI-297-2587
15.0 cm / 6"



Aufrecht
TI-297-2588
13.5 cm / 5½"



Yankauer (Septum Surure Needles)



TI-297-2589



TI-297-2590



TI-297-2591



TI-297-2592



TI-297-2593



TI-297-2594



TI-297-2595



TI-297-2596



TI-297-2597



Kressner
TI-298-2598
20.0 cm / 8"



Cottle-Walsham
23.0 cm / 9"

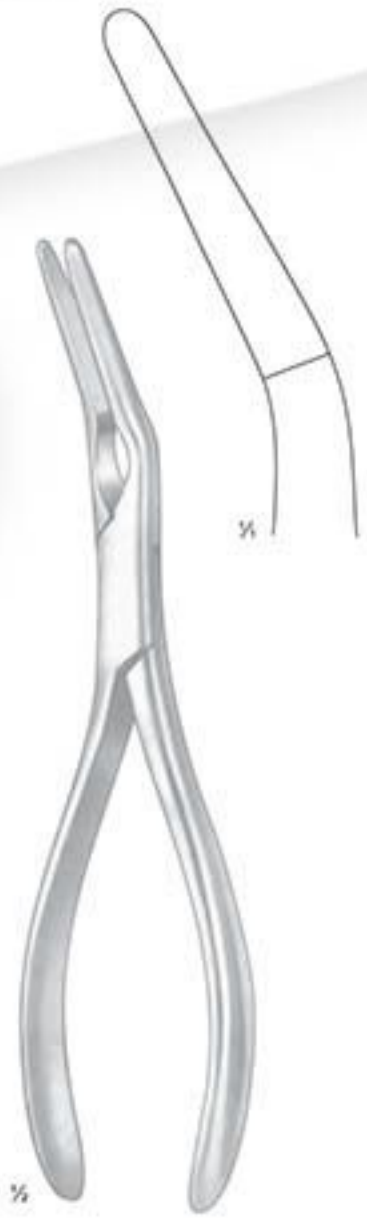

Asch
TI-298-2602
23.0 cm / 9"



Prapp
TI-299-2603
21.0 cm / 8 1/4"



Faulkner
TI-299-2604
21.0 cm / 8 1/4"



Coakley
17.0 cm / 6 3/4"



TI-299-2605



TI-299-2606



TI-299-2607



TI-299-2608



TI-299-2609



TI-299-2610



TI-299-2611



1/2



1/2

Beckmann
22.0 cm / 8 3/4"

TI-300-2612 - TI-300-2617



1/2

Beckmann
22.0 cm / 8 3/4"

TI-300-2618 - TI-300-2623



1/2

TI-300-2612
TI-300-2618



TI-300-2613
TI-300-2619



TI-300-2614
TI-300-2620



TI-300-2615
TI-300-2621



TI-300-2616
TI-300-2622



TI-300-2617
TI-300-2623



1/2

Beckmann
22.0 cm / 8 3/4"



1/2

TI-301-2624



TI-301-2625



TI-301-2626



TI-301-2627



TI-301-2628



1/2

St. Clair-Thomson
21.0 cm / 8 1/4"



1/2

TI-301-2629



TI-301-2630



TI-301-2631



TI-301-2632

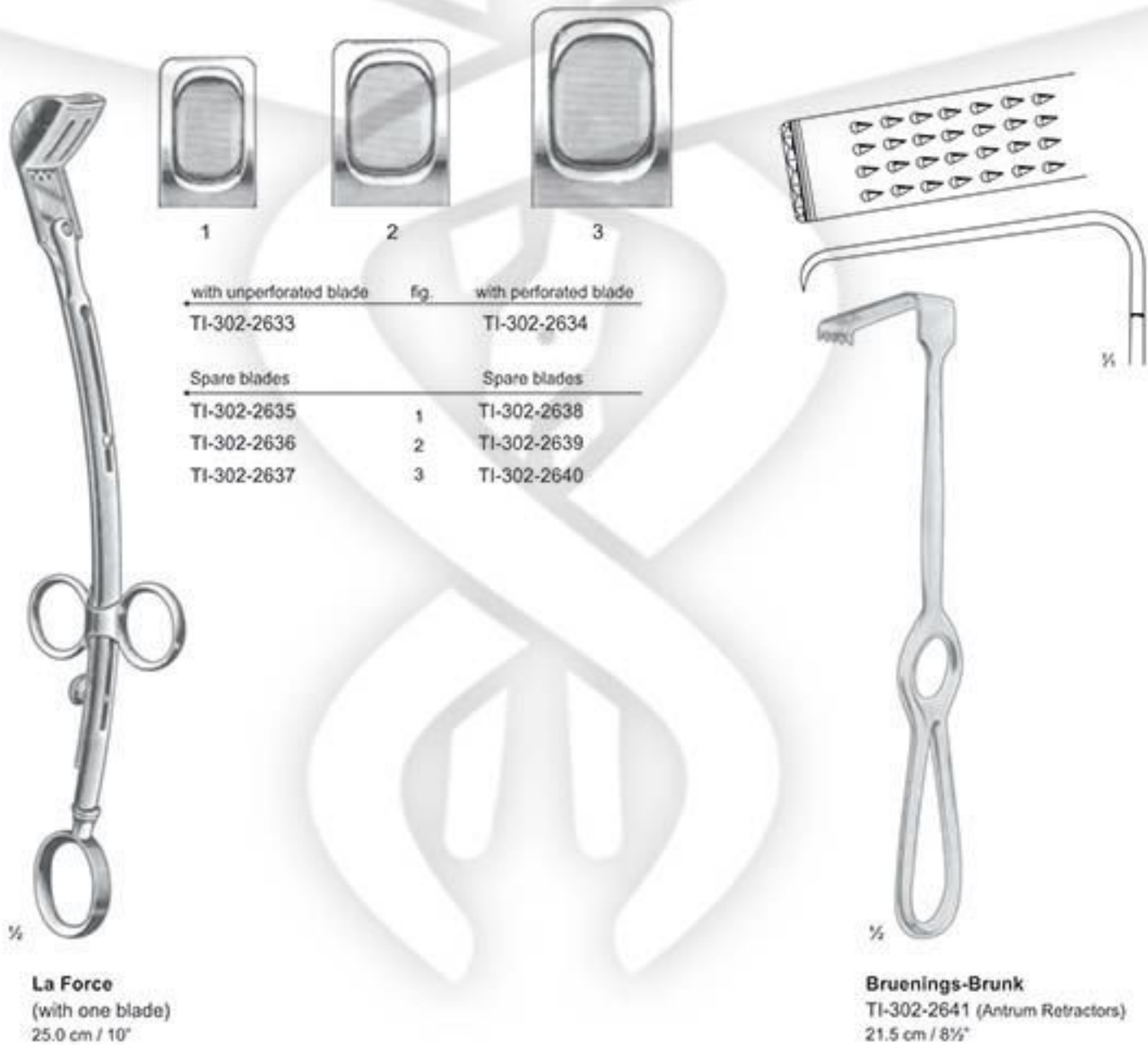

10

CARDIOVASCULAR INSTRUMENTS



TALC INDUSTRIES
ONE STOP FOR MEDICAL EQUIPMENT



TI-303-2642
23.0 cm / 9"



TI-303-2643
22.0 cm / 8 1/4"



TI-303-2644
17.0 cm / 6 3/4"



Gluck
TI-303-2645
22.0 cm / 8 1/4"

with eccentric
sliding blade



Stille
TI-303-2646
21.0 cm / 8 1/4"



Sauerbruch
TI-304-2647
26.0 cm / 10 1/4"



Giertz-Stille
TI-304-2648
27.0 cm / 10 1/2"



Sauerbruch-Frey
TI-304-2649
36.0 cm / 14"



Lebsche
TI-304-2650
25.0 cm / 10"



Brunner
32.0 cm / 12 1/2"

TI-304-2651
for the right hand

TI-304-2652
for the left hand



Lebsche
TI-304-2653
24.5 cm / 9 3/4"

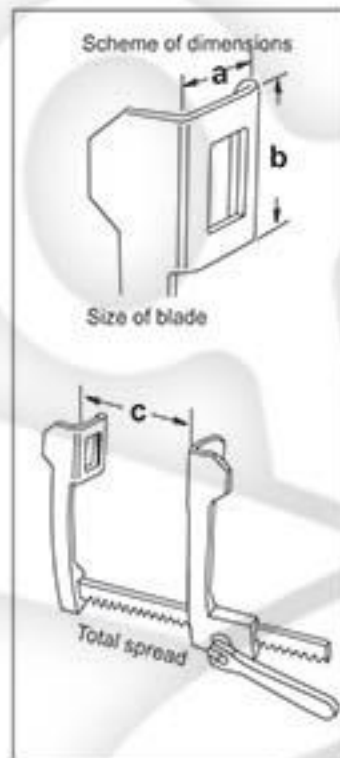

**Cooley
for newborns**

	a	b	c
TI-305-2654	12 mm	17 mm	75 mm



**Cooley
pediatric size**

	a	b	c
TI-305-2655	16 mm	30 mm	105 mm
TI-305-2656	21 mm	44 mm	150 mm



**Cooley
for adults**

	a	b	c
TI-305-2657	37 mm	49 mm	200 mm

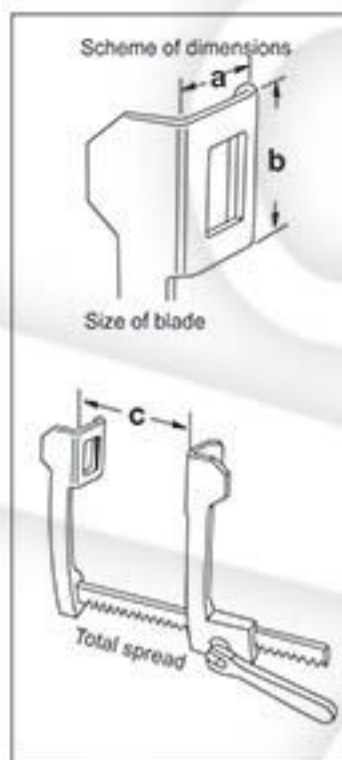

	a	b	c
TI-306-2658	15 mm	15 mm	75 mm



	a	b	c
TI-306-2659	31 mm	31 mm	100 mm



	a	b	c
TI-306-2660	38 mm	44 mm	135 mm
TI-306-2661	52 mm	62 mm	175 mm
TI-306-2662	85 mm	65 mm	175 mm

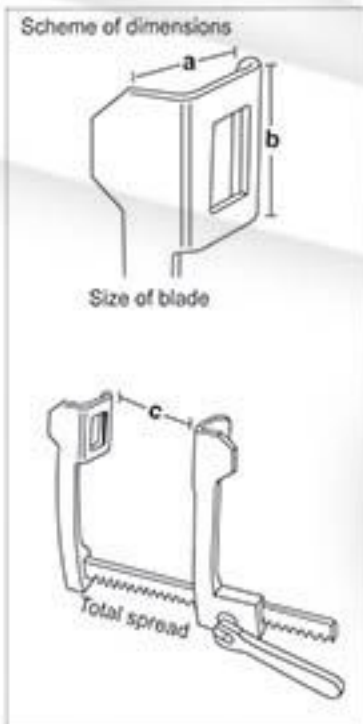

Finocchietto-Baby

	a	b	c
TI-307-2663	18 mm	20 mm	75 mm

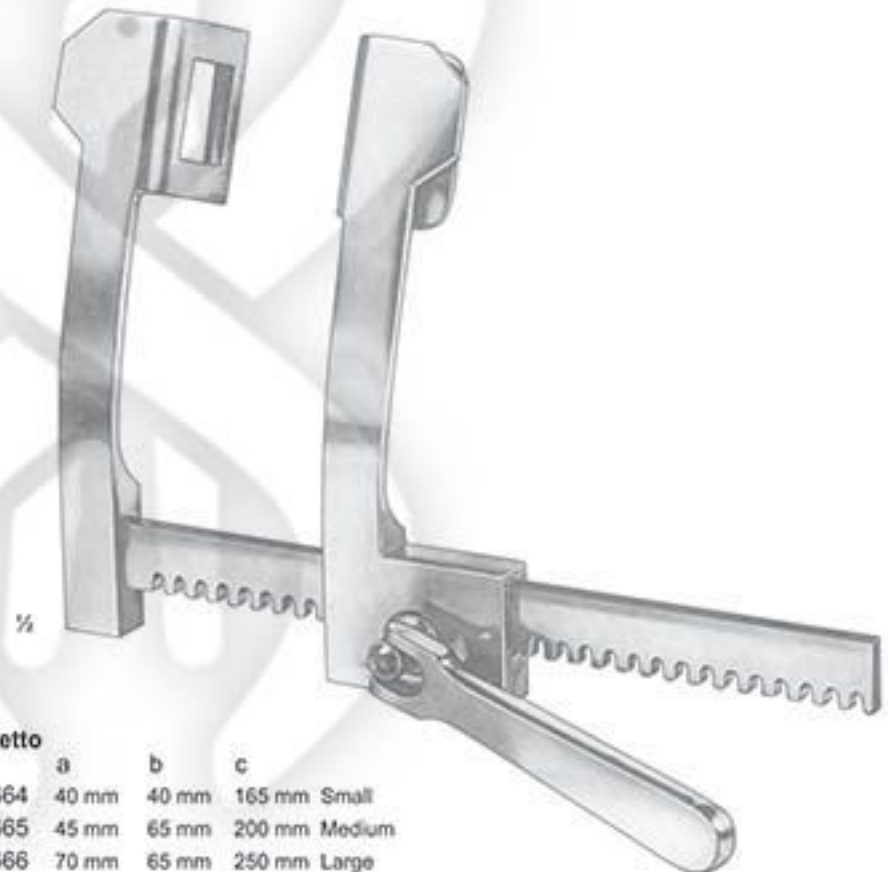

Finocchietto

	a	b	c	
TI-307-2664	40 mm	40 mm	165 mm	Small
TI-307-2665	45 mm	65 mm	200 mm	Medium
TI-307-2666	70 mm	65 mm	250 mm	Large

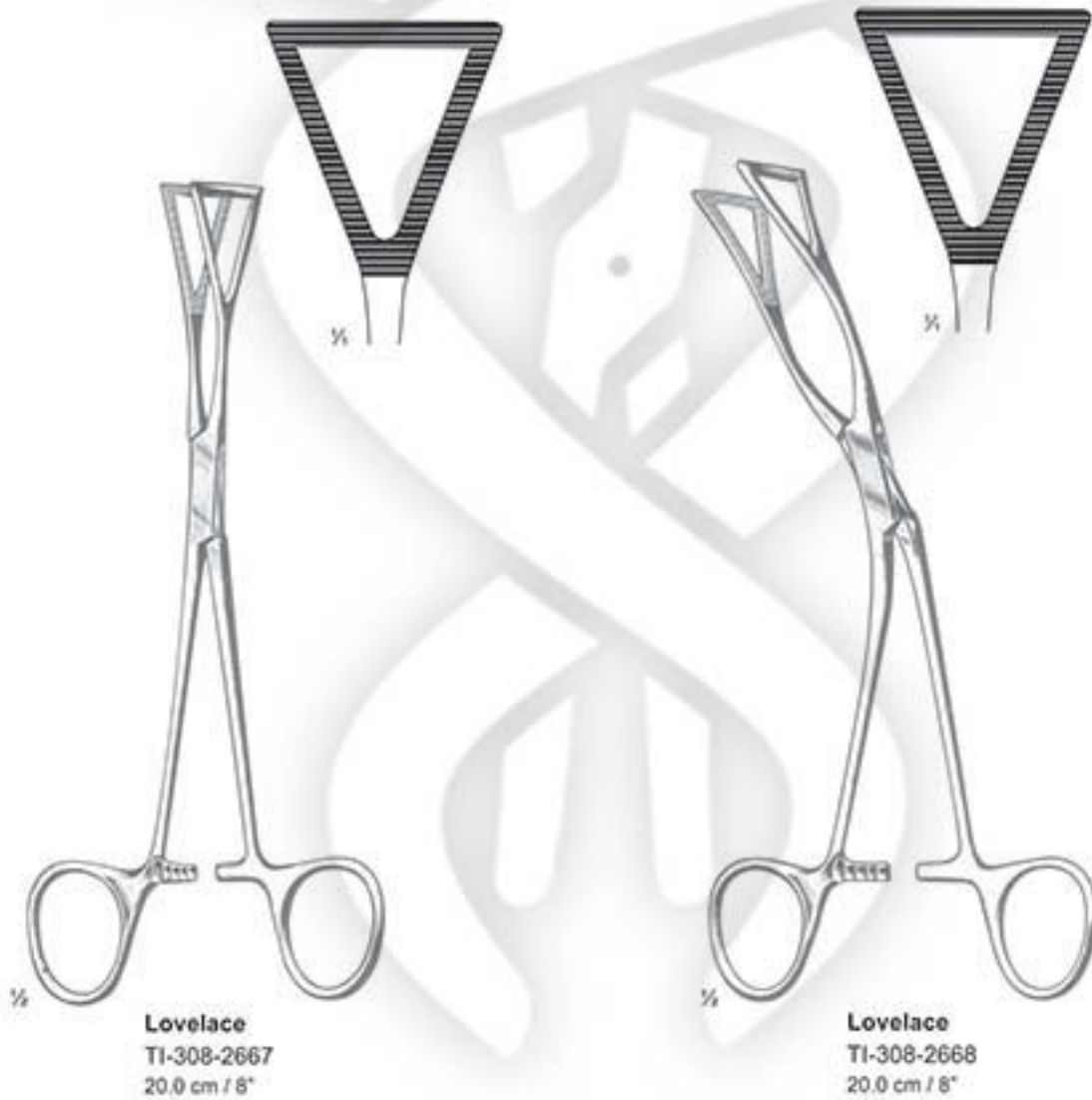



Dale
TI-309-2669
18.5 cm / 7 1/4"



Dale



TI-309-2670
17.0 cm / 6 3/4"



TI-309-2671
17.5 cm / 7"



TI-309-2672
18.5 cm / 7 1/4"

Peripheral vascular clamps

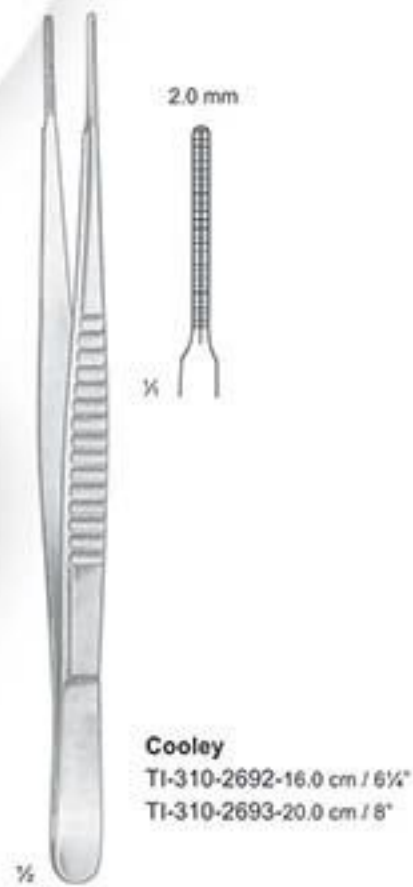
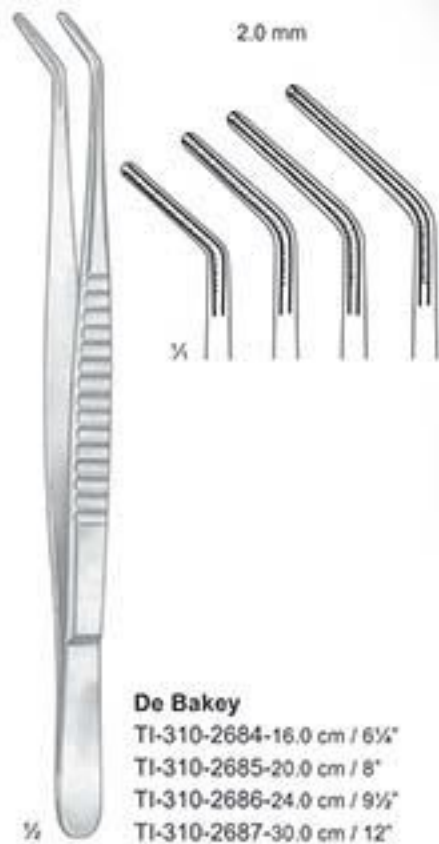
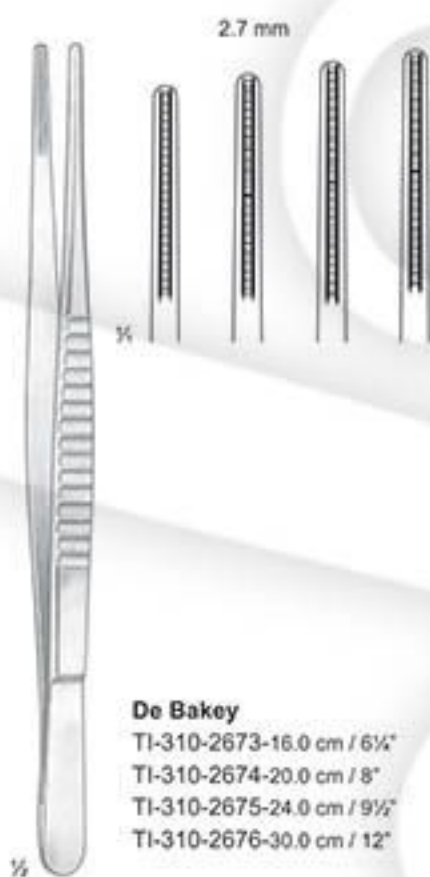



Bulldog



TI-311-2694
7.5 cm / 3"



TI-311-2695
8.5 cm / 3 1/2"



TI-311-2696
10.5 cm / 4 1/4"



TI-311-2697
12.0 cm / 4 3/4"



Bulldog



TI-311-2698
7.0 cm / 2 3/4"



TI-311-2699
8.0 cm / 3 1/4"



TI-311-2700
10.0 cm / 4"



TI-311-2701
11.5 cm / 4 1/2"



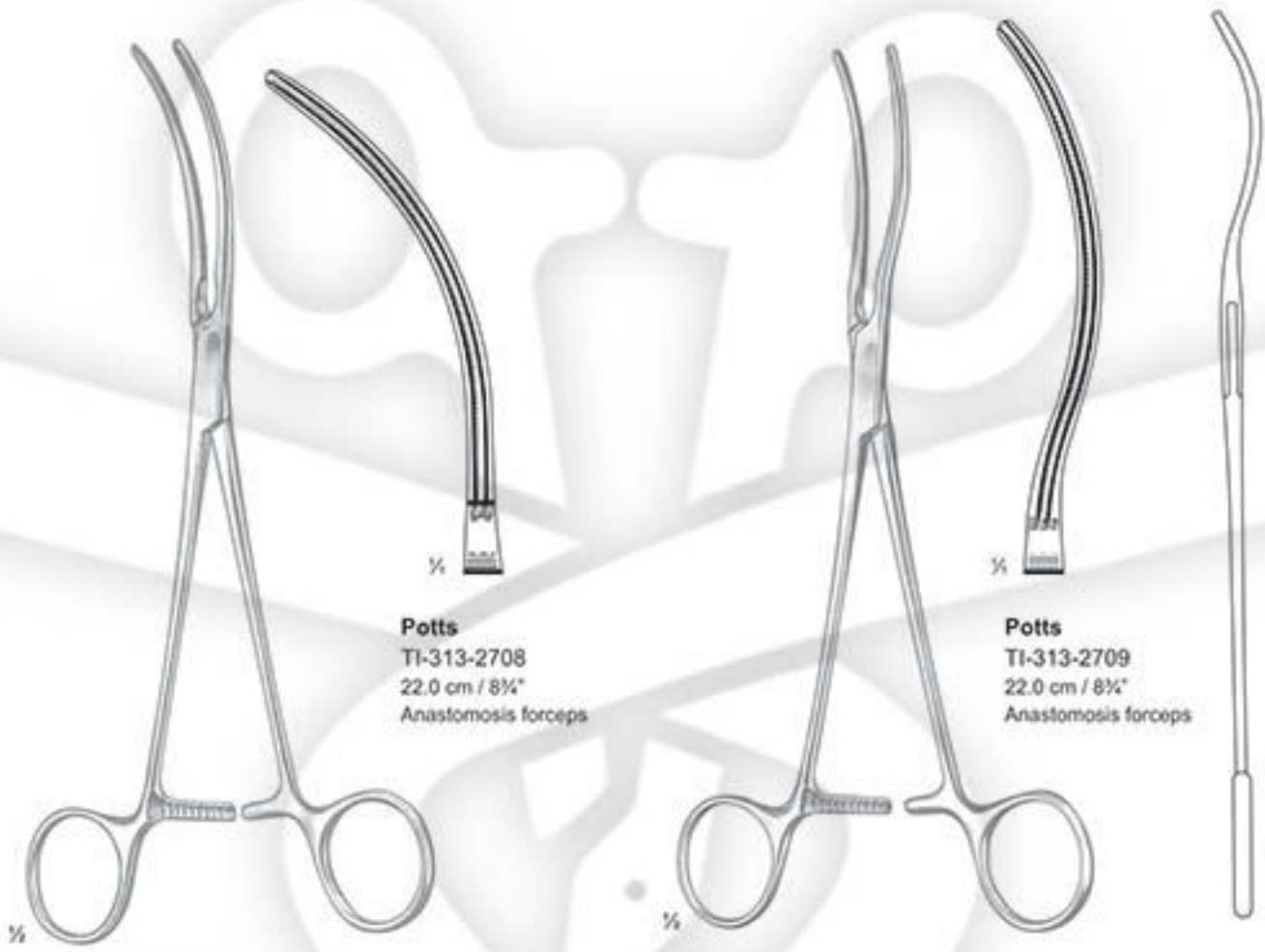

Potts
TI-313-2708
22.0 cm / 8 3/4"
Anastomosis forceps

Potts
TI-313-2709
22.0 cm / 8 3/4"
Anastomosis forceps



TI-313-2710
19.0 cm / 7 1/2"

TI-313-2711
23.0 cm / 9"

De Bakay

Dissecting and Ligature Forceps

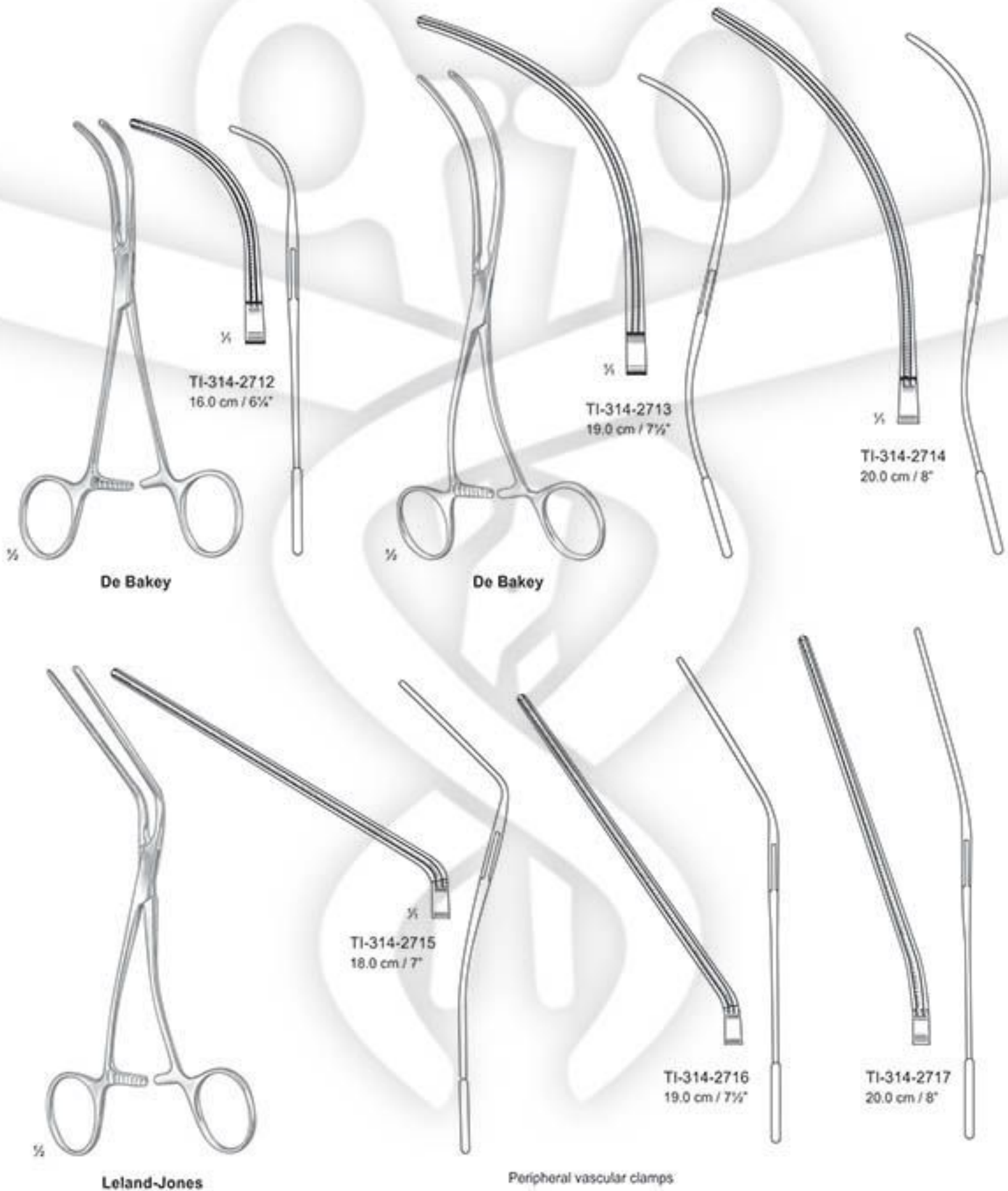



Bainbridge

TI-315-2718
15.0 cm / 6"



TI-315-2719
18.0 cm / 7"



Bainbridge

TI-315-2720
15.0 cm / 6"



TI-315-2721
18.0 cm / 7"



De Bakey

Renal artery clamp



TI-315-2722
20.0 cm / 8"



Aortic aneurysm clamps



TI-316-2723
26.0 cm / 10¼"



TI-316-2724
27.0 cm / 10½"



TI-316-2725
31.0 cm / 12¼"



TI-316-2726
33.0 cm / 13"





De Bakey
TI-317-2727
28.0 cm / 11"

Aortic aneurysm clamps

De Bakey
TI-317-2728
30.0 cm / 11 1/2"

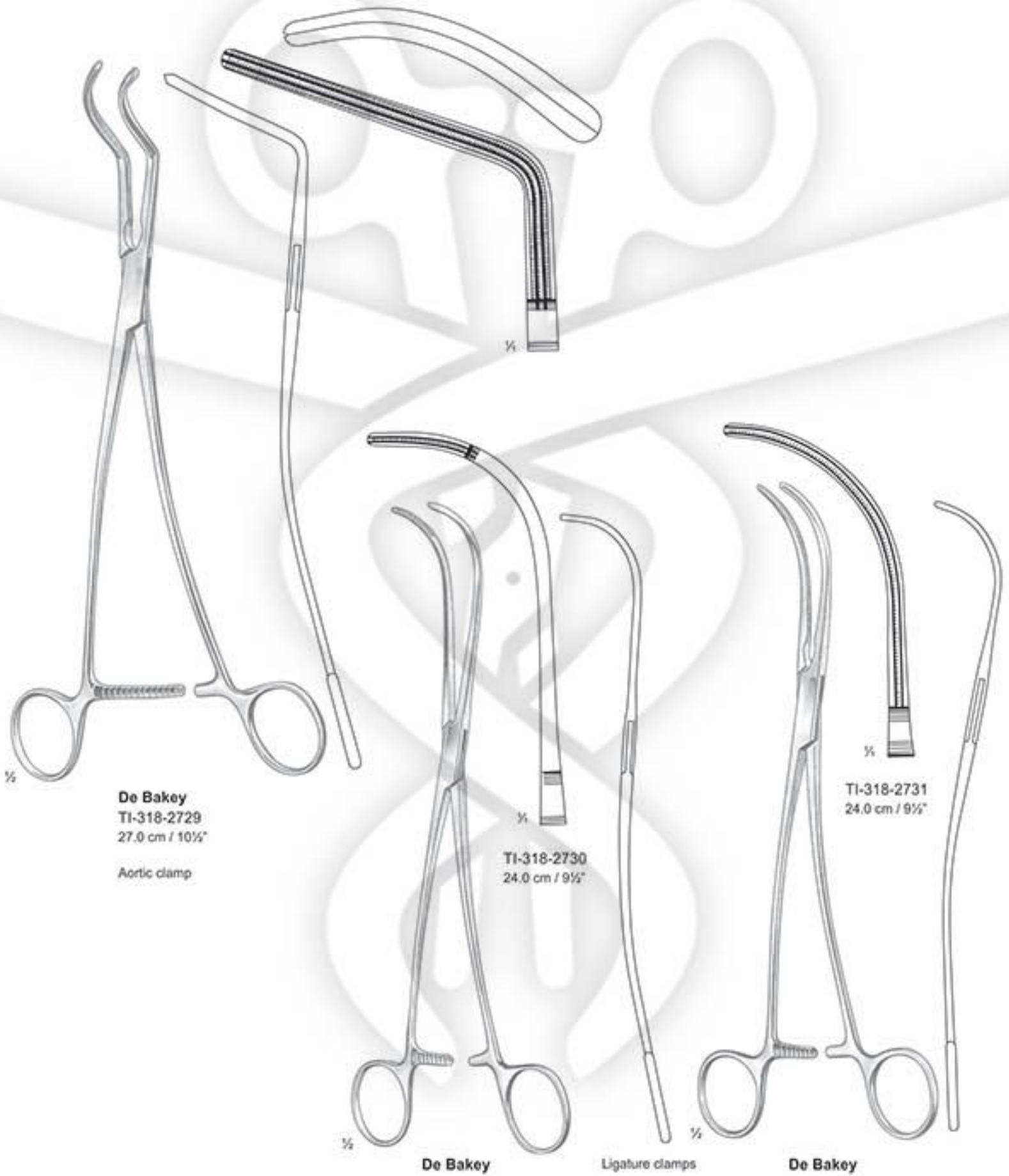



De Bakey
TI-319-2732
26.0 cm / 10 $\frac{1}{4}$ "
Aortic clamp

De Bakey
TI-319-2733
25.0 cm / 10"
Ligature Forceps

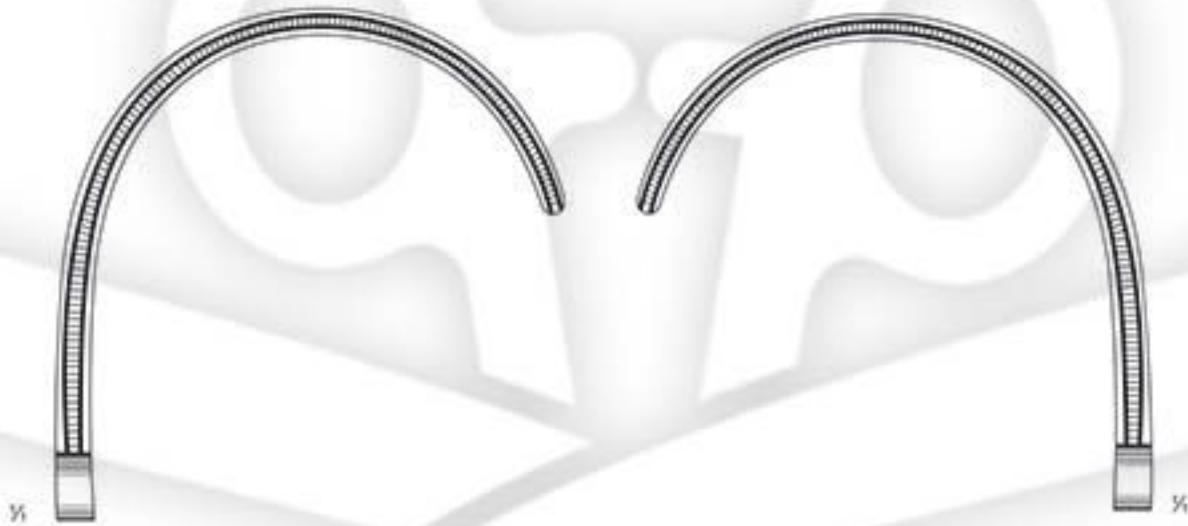

1/4
Weber
TI-320-2734
26.0 cm / 10 1/4"
left

Aortic clamps

1/4
Weber
TI-320-2735
26.0 cm / 10 1/4"
right

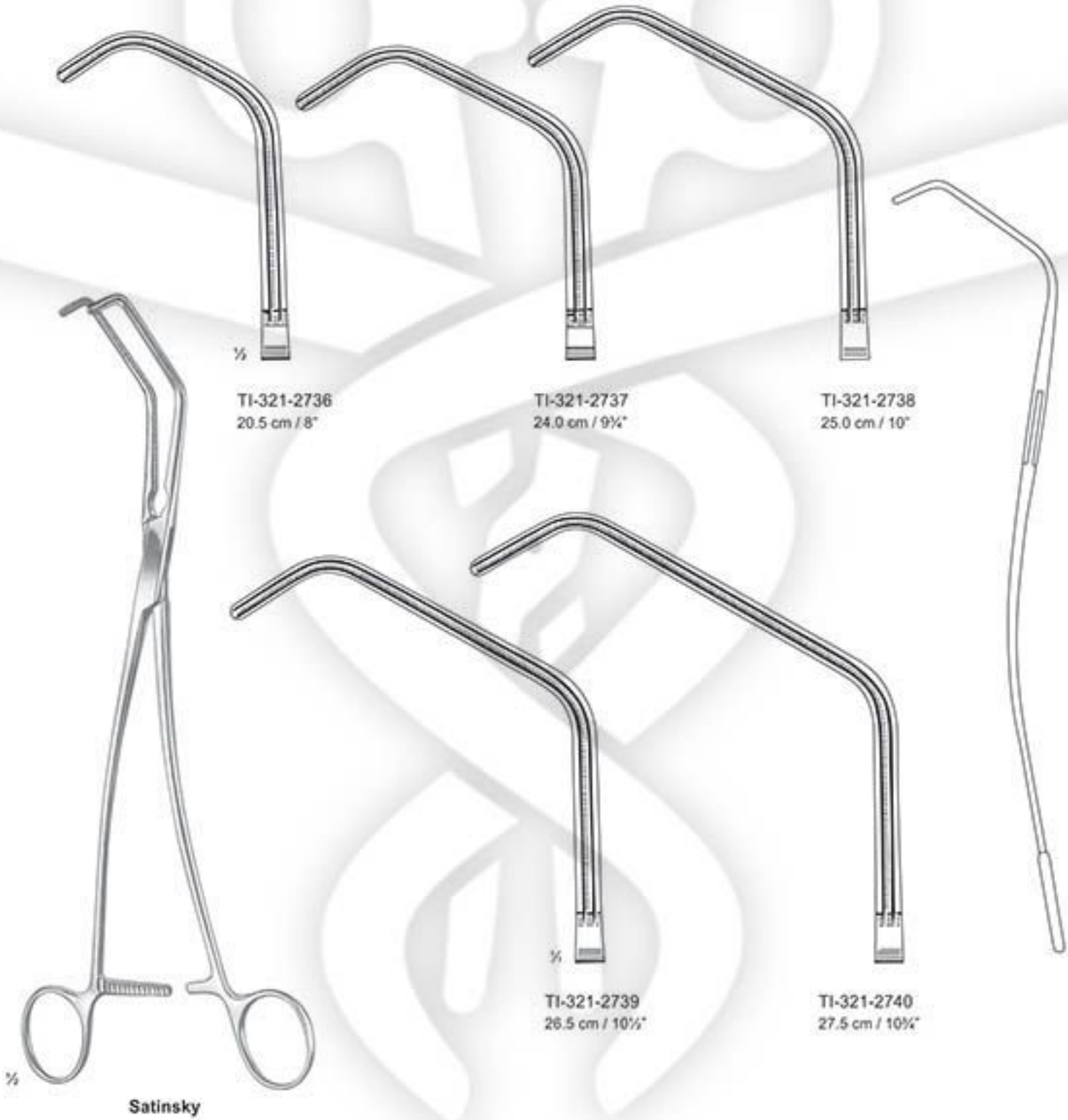



Harken

1/2

TI-322-2741
24.0 cm / 9 1/2"

Auricle clamps

1/2

TI-322-2742
24.0 cm / 9 1/2"

1/2

TI-322-2743
24.0 cm / 9 1/2"

1/2

TI-322-2744
24.0 cm / 9 1/2"

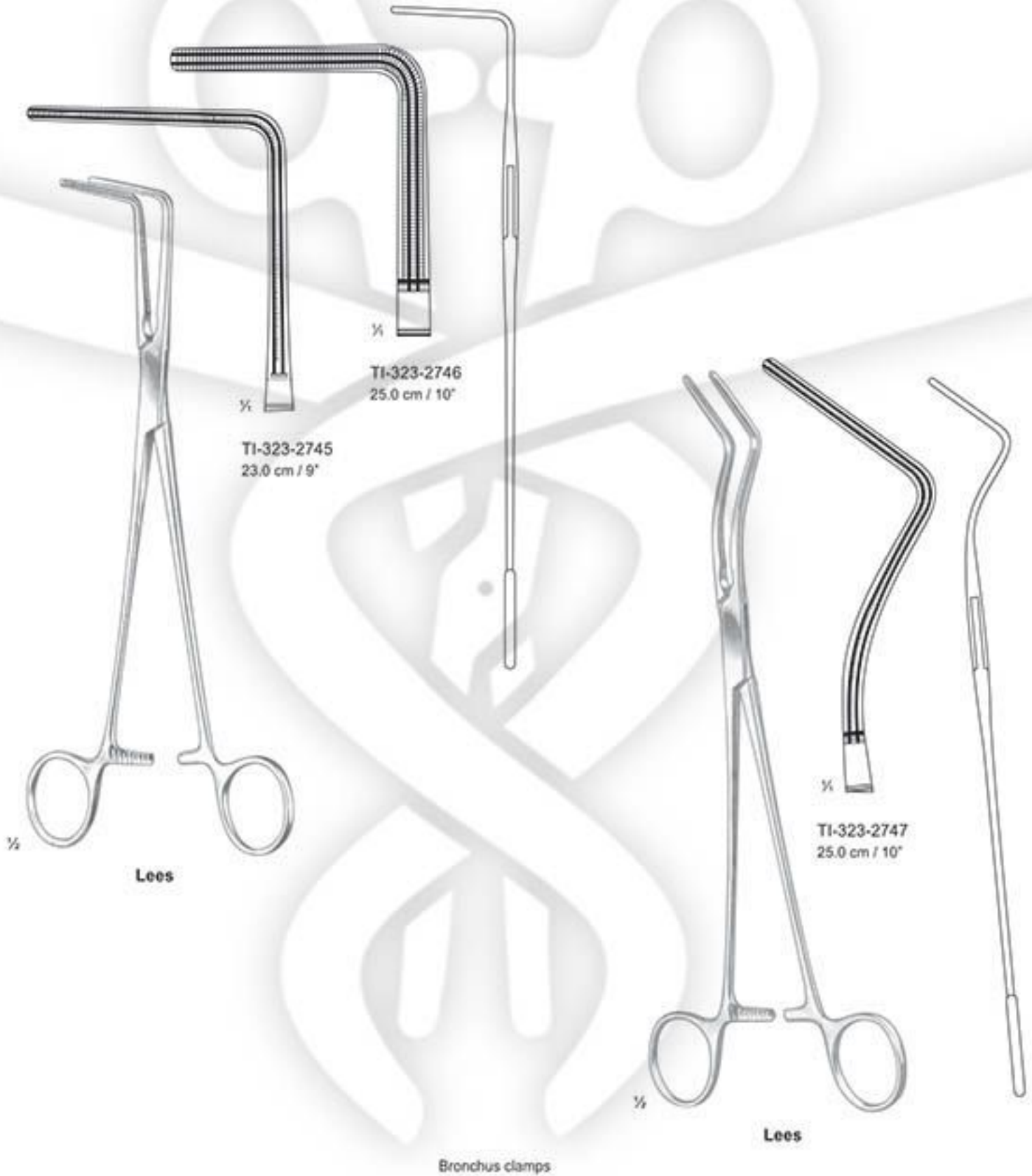



½

Lambert-Kay



½

TI-324-2748



TI-324-2749



½

De Bakey



½

TI-324-2750
17.0 cm / 6¾"

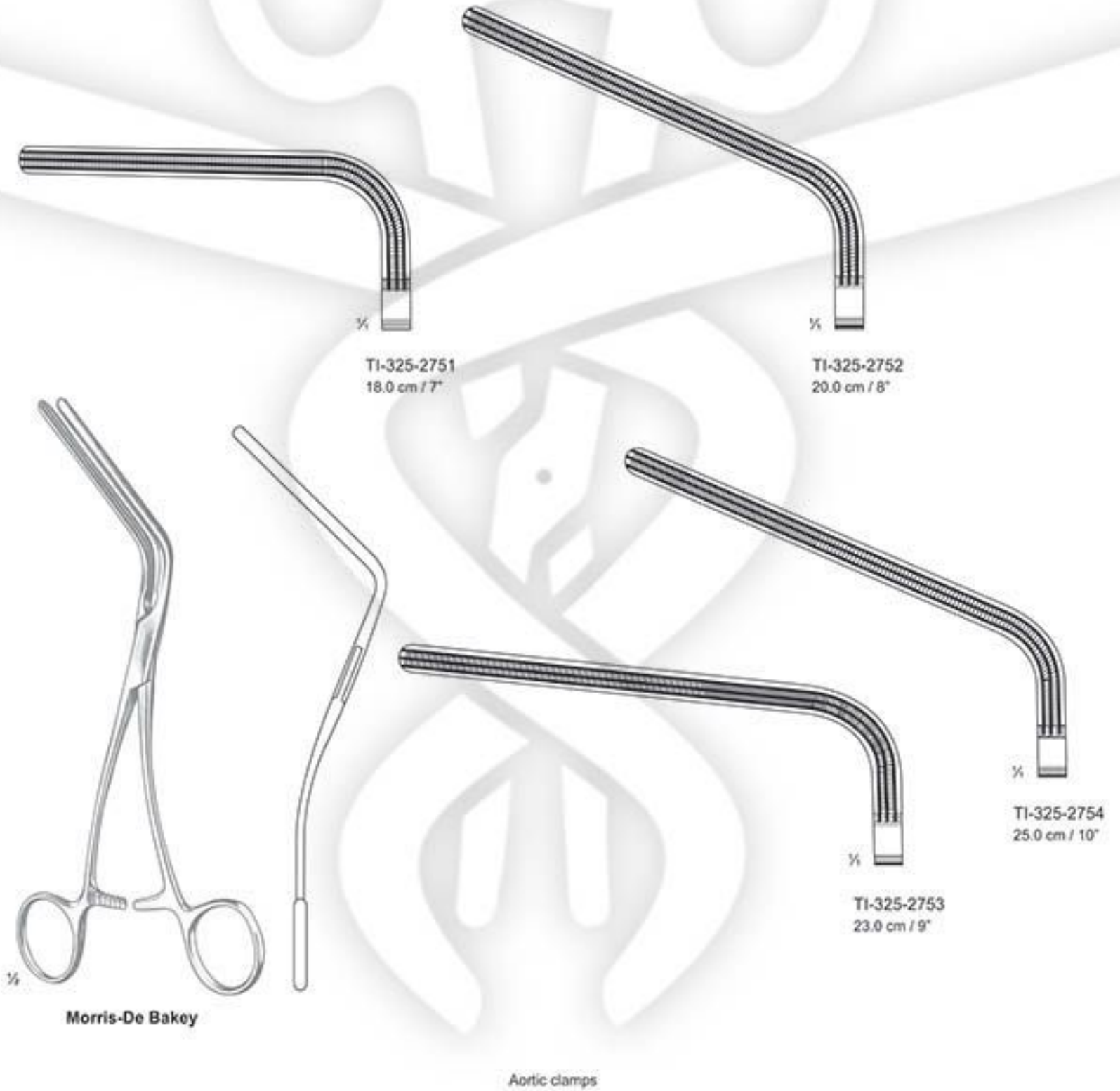



De Bakey-Bahnson



TI-326-2755
23.0 cm / 9"



TI-326-2756
24.0 cm / 9 1/2"



TI-326-2757
25.0 cm / 10"

Aortic aneurysm clamps/iliac artery



TI-327-2758
21.5 cm / 8½"



TI-327-2759
23.0 cm / 9"



TI-327-2760
27.0 cm / 10½"



TI-327-2761
31.5 cm / 12½"



Coarctation clamps



TI-327-2762
21.5 cm / 8½"



TI-327-2763
23.0 cm / 9"



TI-327-2764
27.0 cm / 10½"



TI-327-2765
31.5 cm / 12½"



De Bakey

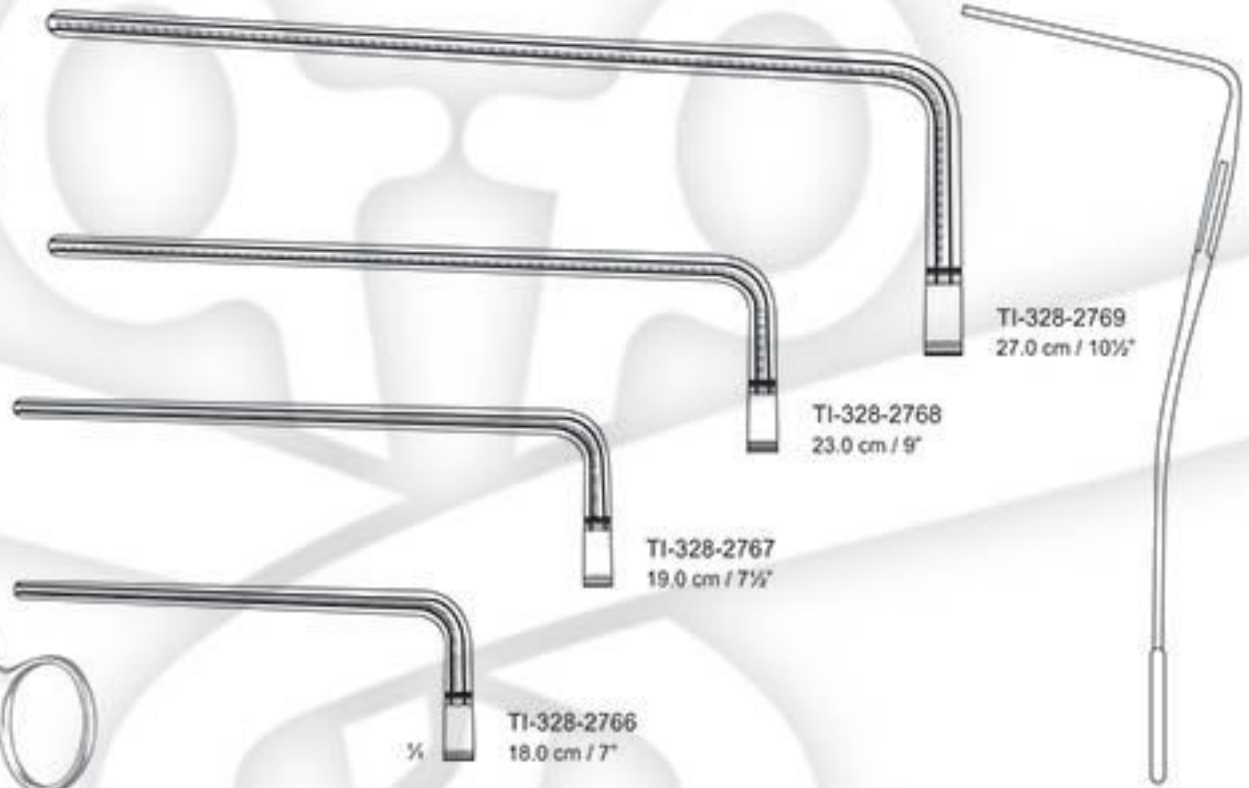

TI-328-2769
27.0 cm / 10½"

TI-328-2768
23.0 cm / 9"

TI-328-2767
19.0 cm / 7½"

TI-328-2766
18.0 cm / 7"



Multi purpose clamps



TI-328-2770
20.0 cm / 8"

TI-328-2771
21.0 cm / 8¼"

TI-328-2772
25.0 cm / 10"

TI-328-2773
29.0 cm / 11¼"



De Bakey-Pean



TI-329-2774
12.0 cm / 4 1/4"



TI-329-2775
14.0 cm / 5 1/2"



TI-329-2776
16.0 cm / 6 1/4"



TI-329-2777
18.0 cm / 7"



TI-329-2778
20.0 cm / 8"



De Bakey-Pean



TI-329-2779
12.0 cm / 4 1/4"



TI-329-2780
14.0 cm / 5 1/2"



TI-329-2781
16.0 cm / 6 1/4"



TI-329-2782
18.0 cm / 7"



TI-329-2783
20.0 cm / 8"



De Bakay
TI-330-2784
17.0 cm / 6 $\frac{3}{4}$ "



De Bakay
TI-330-2785
16.0 cm / 6 $\frac{1}{4}$ "



De Bakay
TI-330-2786
15.0 cm / 6"



De Bakay
TI-330-2787
15.0 cm / 6"



De Bakay
TI-330-2788
17.0 cm / 6 $\frac{3}{4}$ "

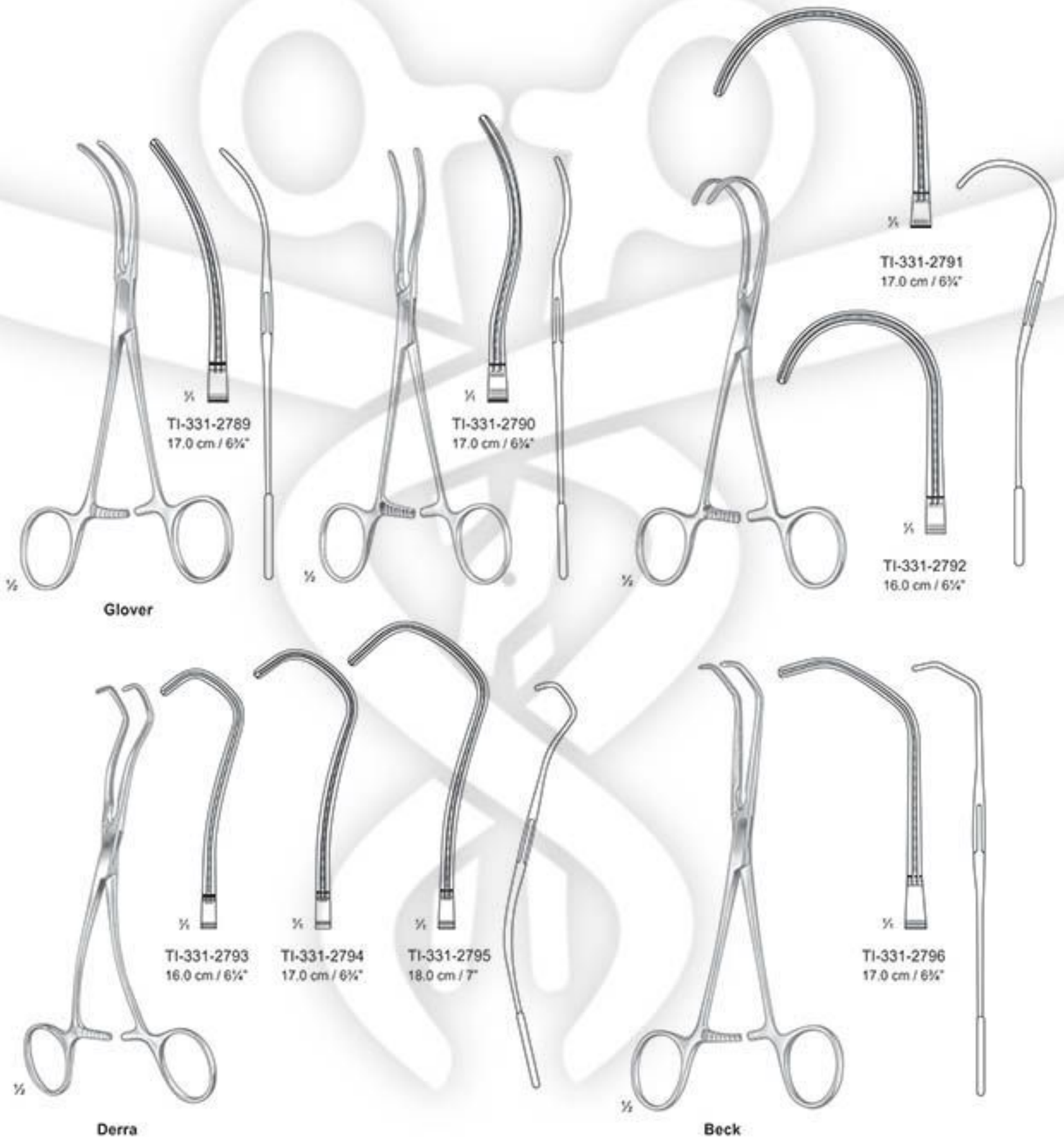



De Bakey
TI-332-2797
10.0 cm / 4"



De Bakey
TI-332-2798
11.0 cm / 4 1/4"



De Bakey
TI-332-2799
12.0 cm / 4 1/2"



De Bakey
TI-332-2800
12.0 cm / 4 3/4"



De Bakey
TI-332-2801
13.0 cm / 5 1/4"

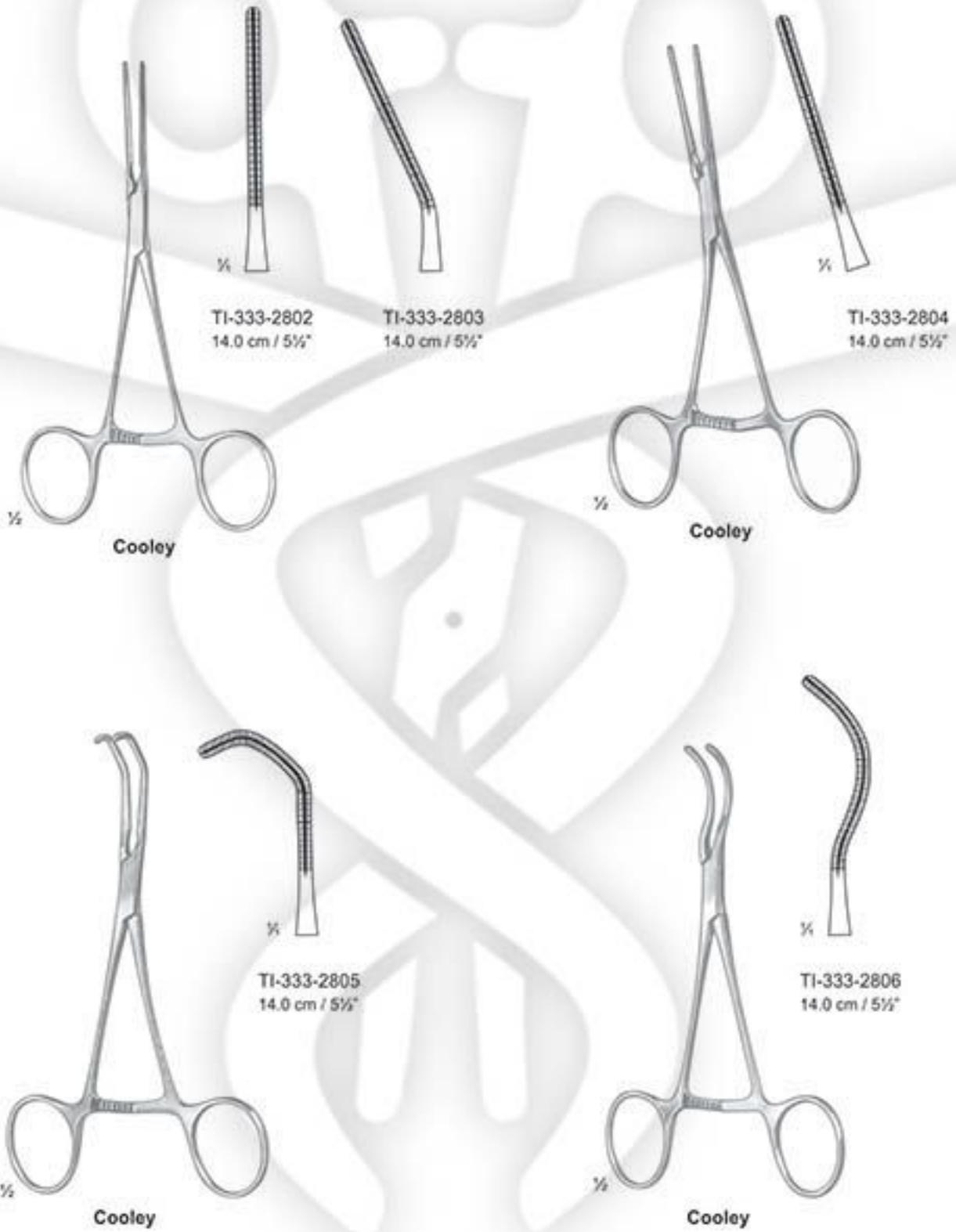

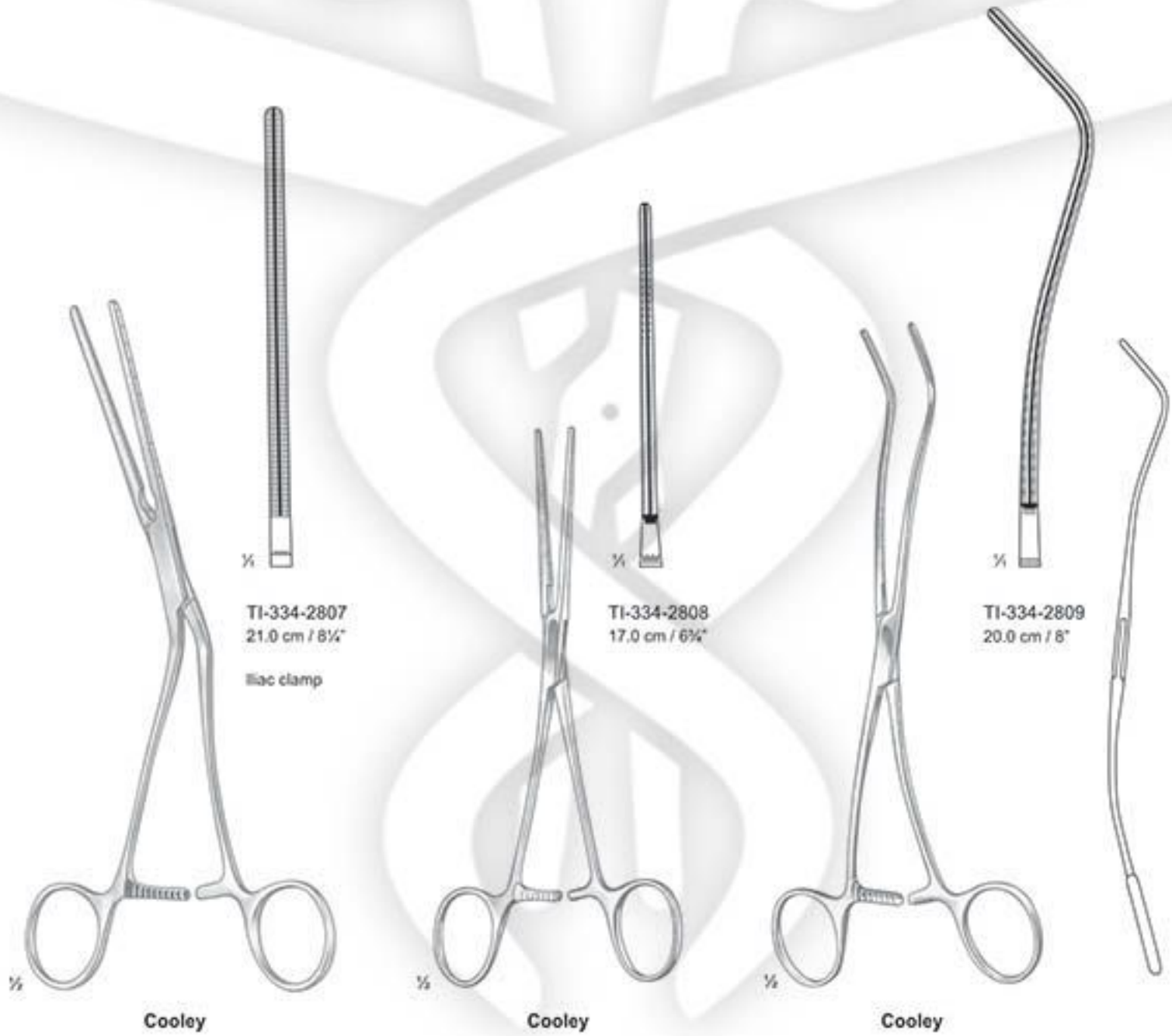



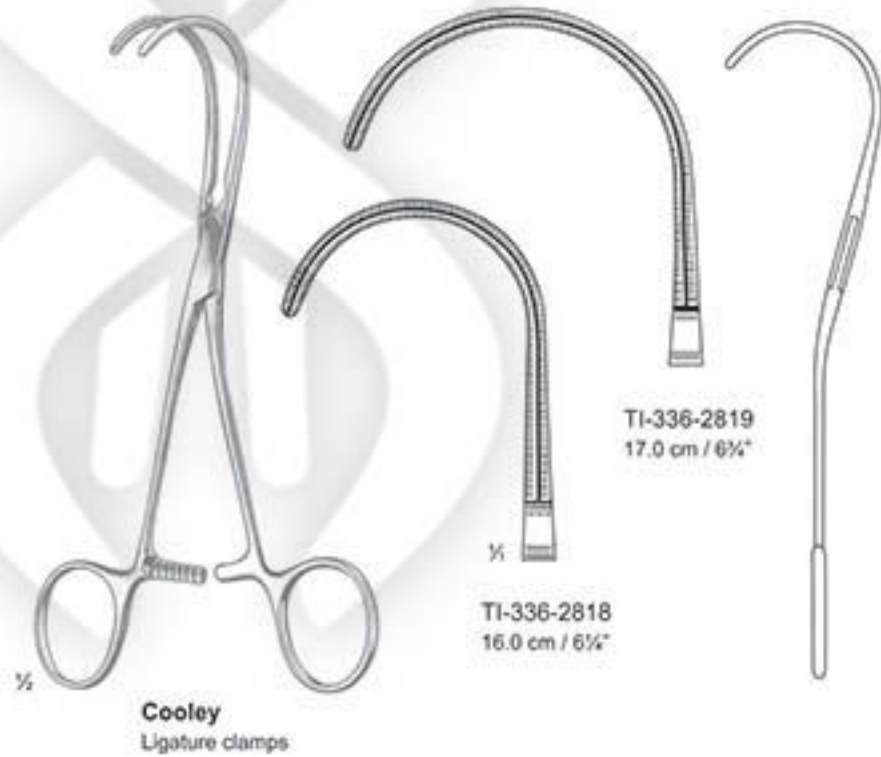



Olivecrona

TI-337-2820- 30.0 cm / 12"
 TI-337-2821- 40.0 cm / 16"
 TI-337-2822- 50.0 cm / 20"
 TI-337-2823- 60.0 cm / 24"
 TI-337-2824- 70.0 cm / 28"



TI-337-2825



Martel
 TI-337-2826
 33.0 cm / 13"



INTESTINE STOMACH RECTUM INSTRUMENTS





Allis-Baby
 TI-338-2827
 12.0 cm / 4 3/4"
 4 x 5 teeth



Allis Tissue

4 : 5
 1/2 (S)
 TI-338-2828
 15.0 cm / 6"

5 : 6
 (S)
 TI-338-2829
 15.0 cm / 6"
 TI-338-2830
 19.0 cm / 7 1/2"
 TI-338-2831
 25.0 cm / 10"



Allis-Atrauma



TI-338-2832
 16.0 cm / 6 1/4"



TI-338-2833
 20.0 cm / 8"



TI-338-2834
 25.0 cm / 10"



TI-338-2835
 30.0 cm / 12"



Allis-Adair
TI-339-2836
15.0 cm / 6"
10 x 11 teeth



Boys-Allis
TI-339-2837
15.0 cm / 6"



Lockwood-Allis
TI-339-2838- 16.0 cm / 6 1/4"
TI-339-2839- 20.0 cm / 8"



Judd-Allis
TI-339-2840- 15.0 cm / 6"
TI-339-2841- 19.0 cm / 7 1/2"



Thomas-Allis
TI-339-2842
20.0 cm / 8"



Allis
TI-339-2843
20.0 cm / 8"



Lockwood
TI-339-2844
20.0 cm / 8"

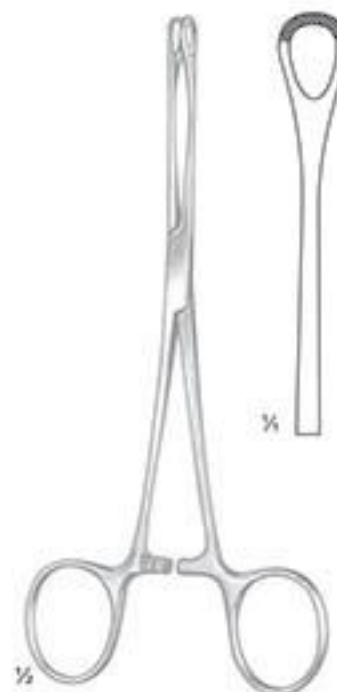

Williams
TI-339-2845
16.0 cm / 6 1/4"



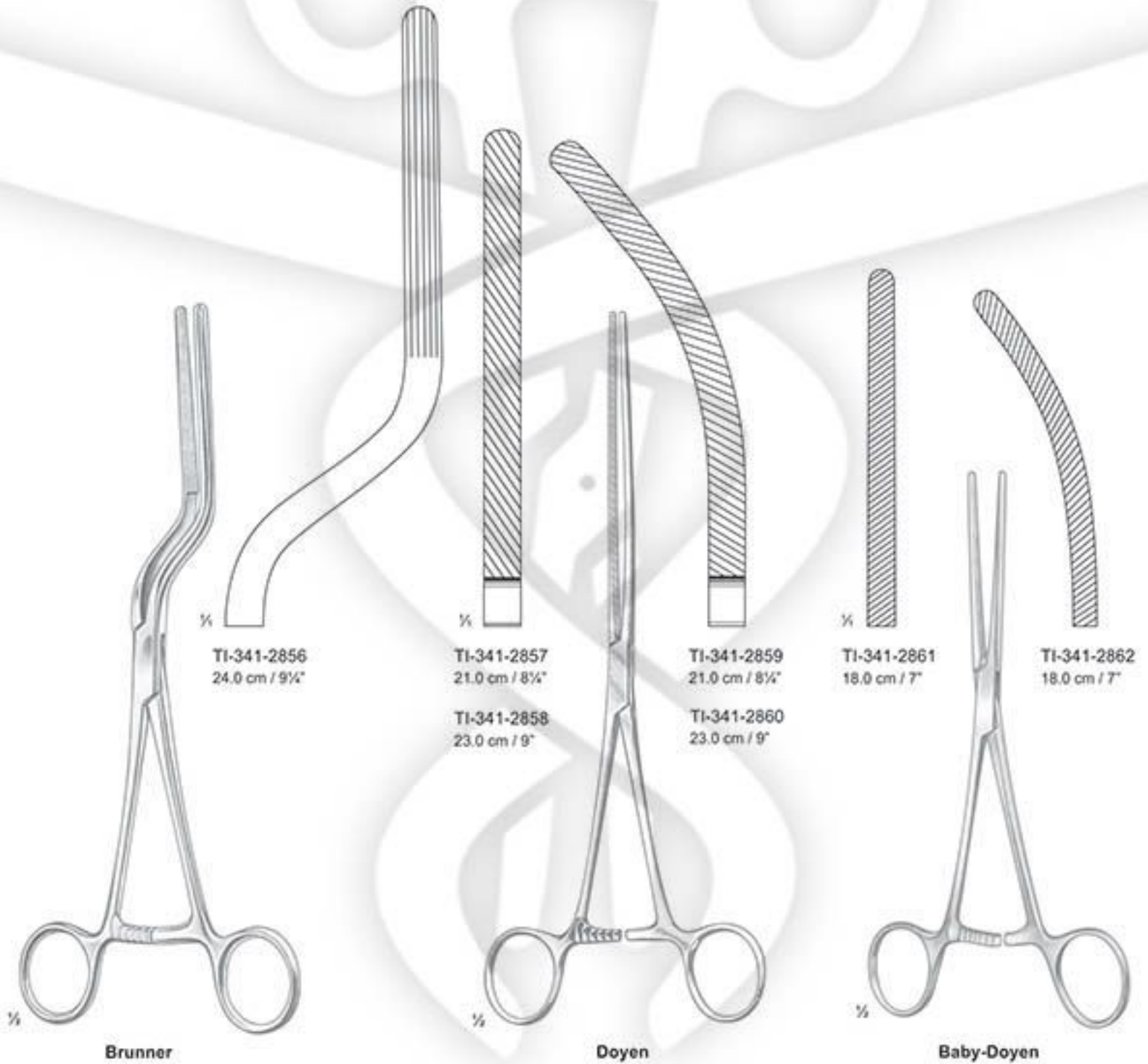

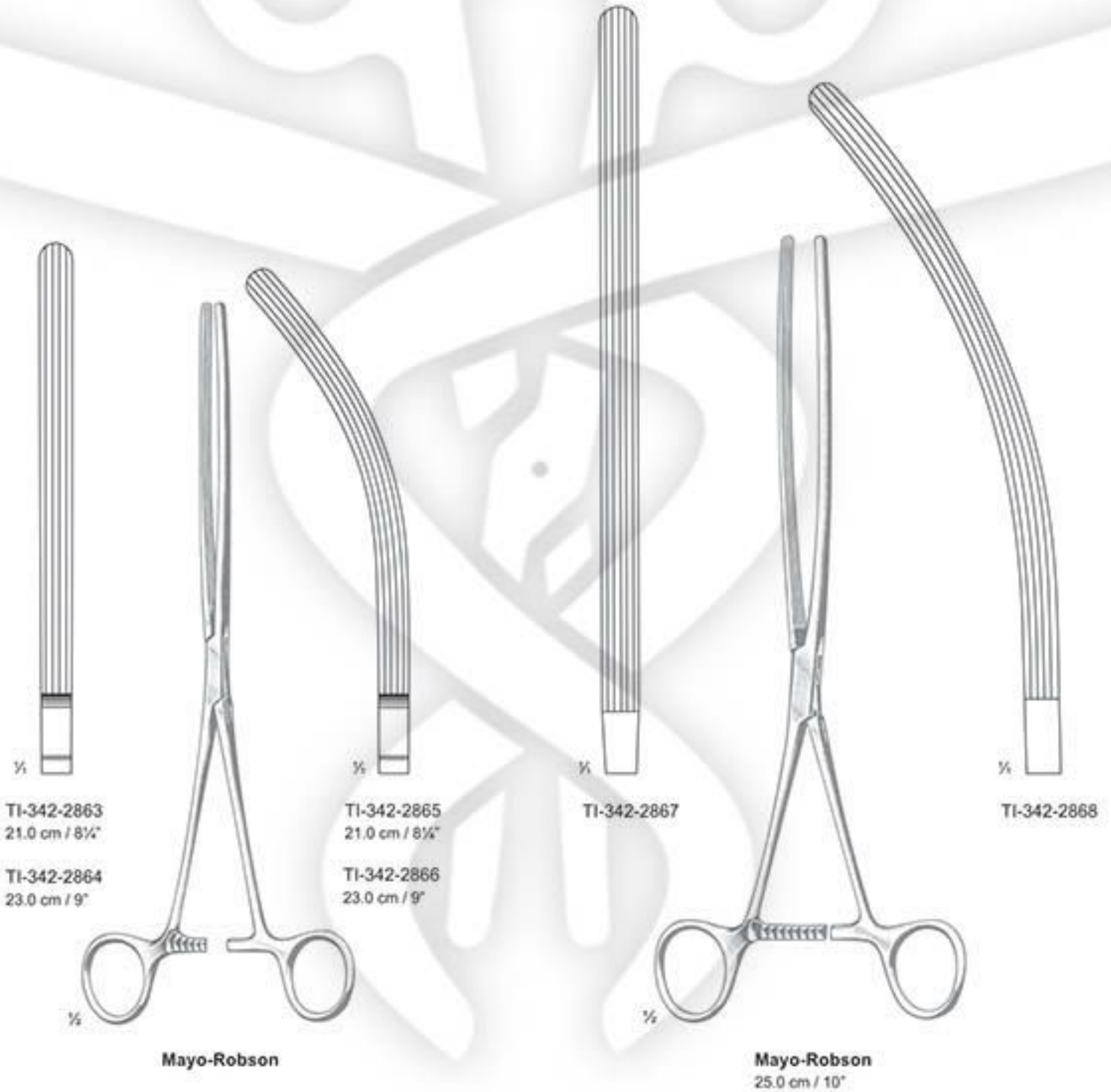

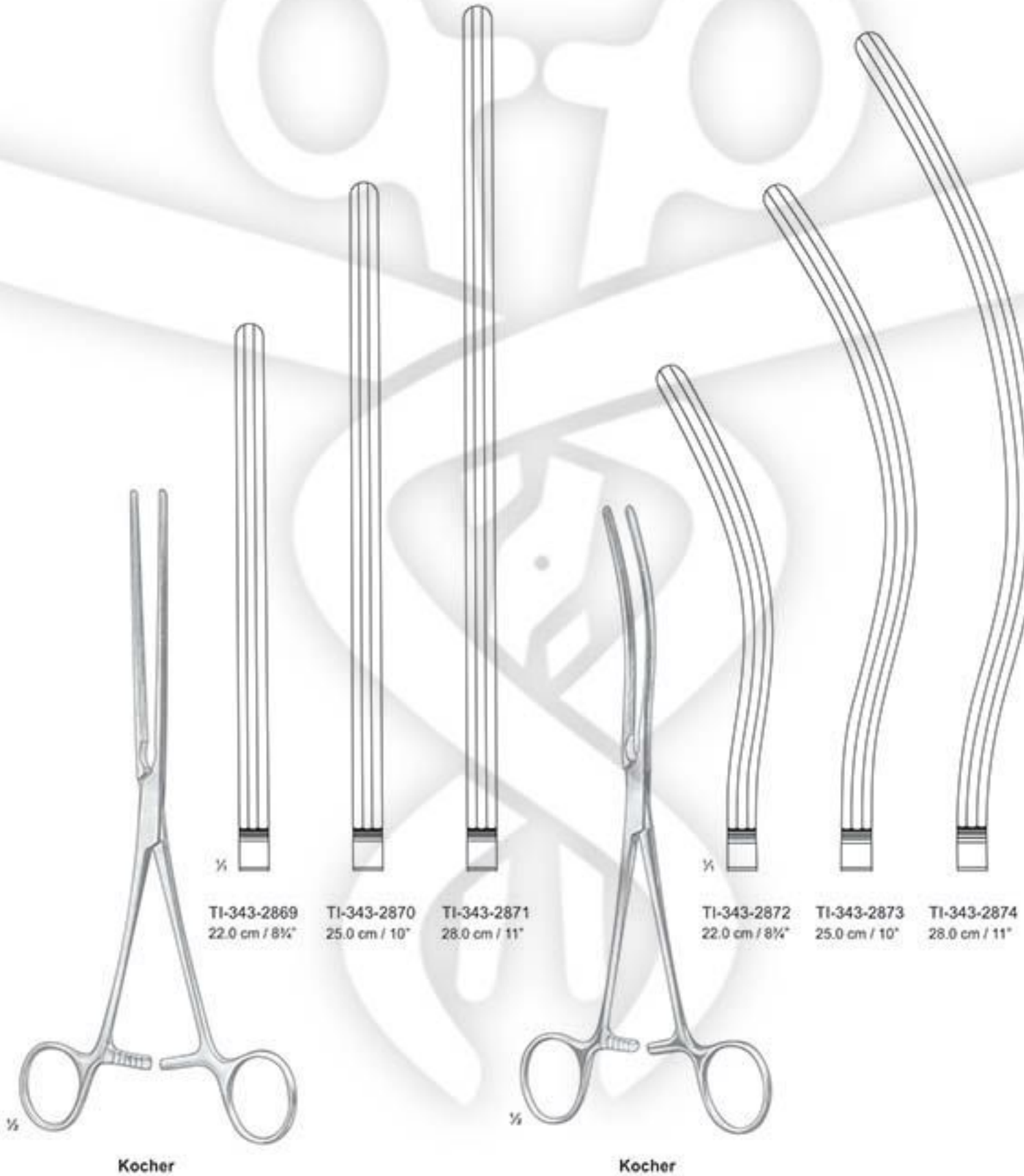

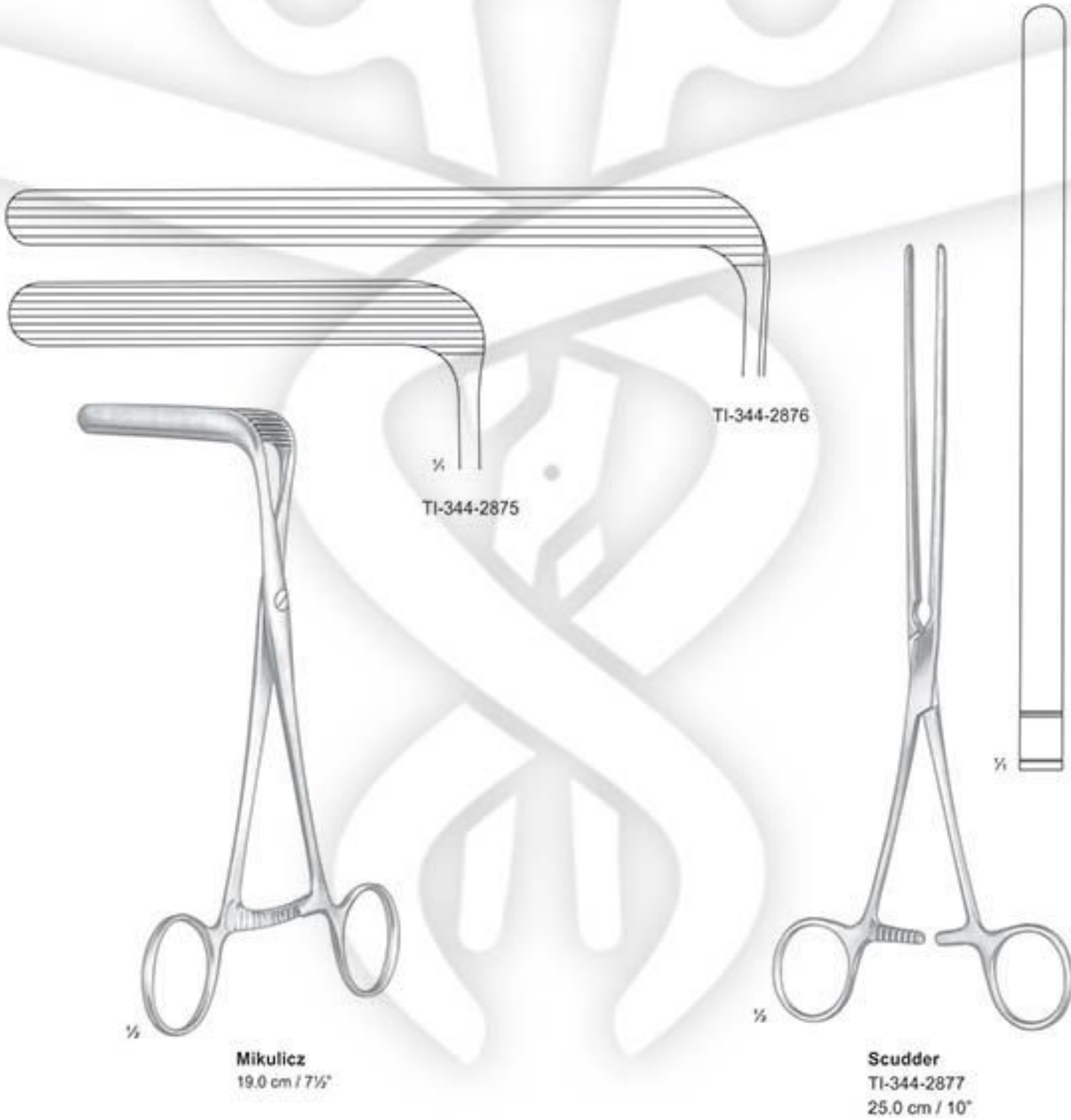

Mikulicz
19.0 cm / 7 1/2"

Scudder
TI-344-2877
25.0 cm / 10"

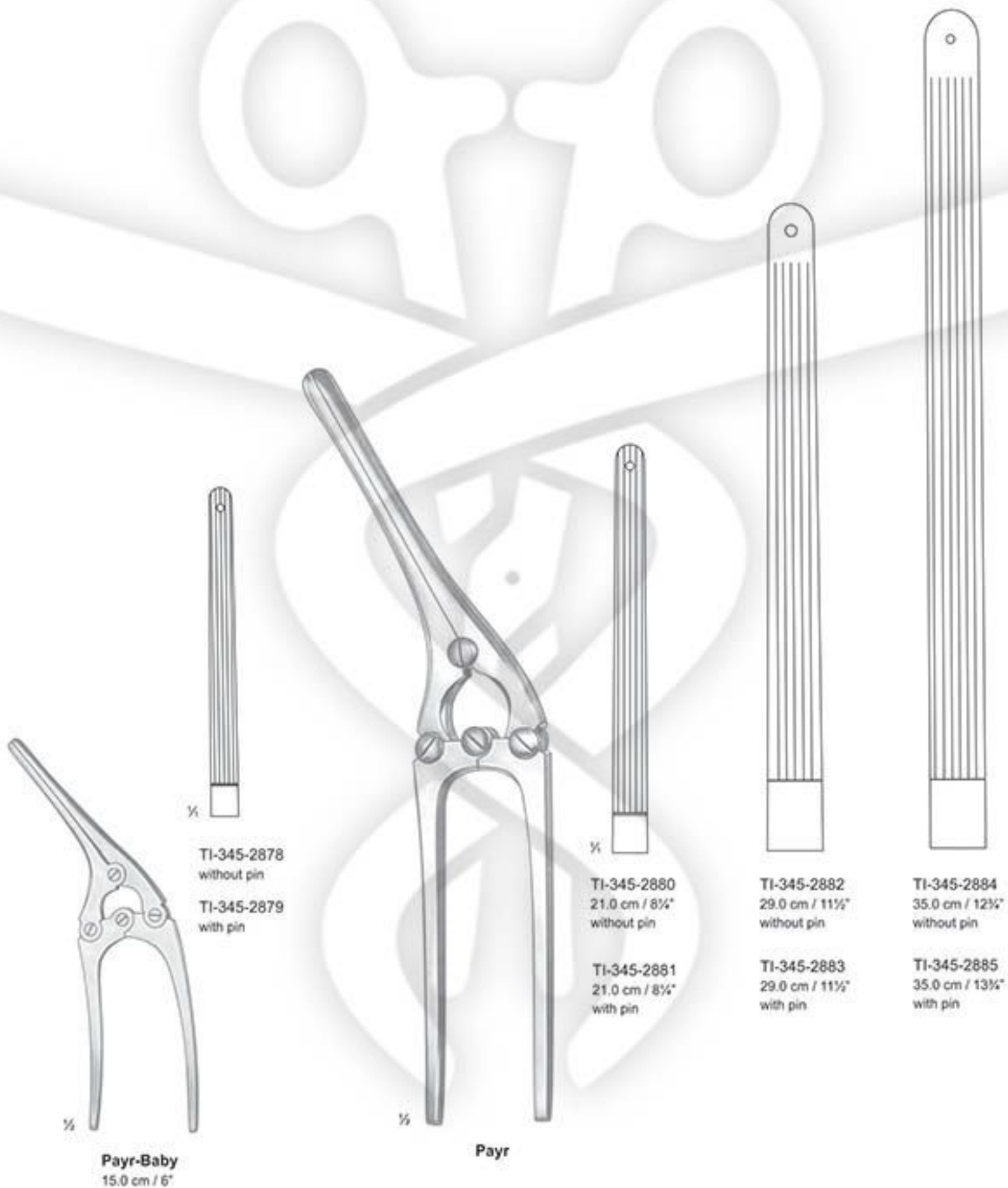



TI-346-2886
16.0 cm / 6¼"



TI-346-2887
18.0 cm / 7"



TI-346-2888
21.0 cm / 8¼"



TI-346-2889
23.0 cm / 9"



TI-346-2890
16.0 cm / 6¼"



TI-346-2891
18.0 cm / 7"



TI-346-2892
21.0 cm / 8¼"



TI-346-2893
23.0 cm / 9"



with interchangeable fiber optic light carrier.



Ives-Fansler
TI-348-2898
22 mm ø



Ives-Fansler
TI-348-2899
22 mm ø



Hirschmann
TI-348-2900 - 16 mm ø x 65mm
TI-348-2901 - 19 mm ø x 65mm
TI-348-2902 - 22 mm ø x 65mm



Kelly
TI-348-2903 - 21 mm ø x 50mm
TI-348-2904 - 27 mm ø x 50mm



Kelly
TI-348-2905 - 22 mm ø x 50mm
TI-348-2906 - 22 mm ø x 100mm
TI-348-2907 - 22 mm ø x 140mm



Newman
TI-348-2908 - 16 mm ø x 63mm
TI-348-2909 - 19 mm ø x 63mm
TI-348-2910 - 23 mm ø x 63mm

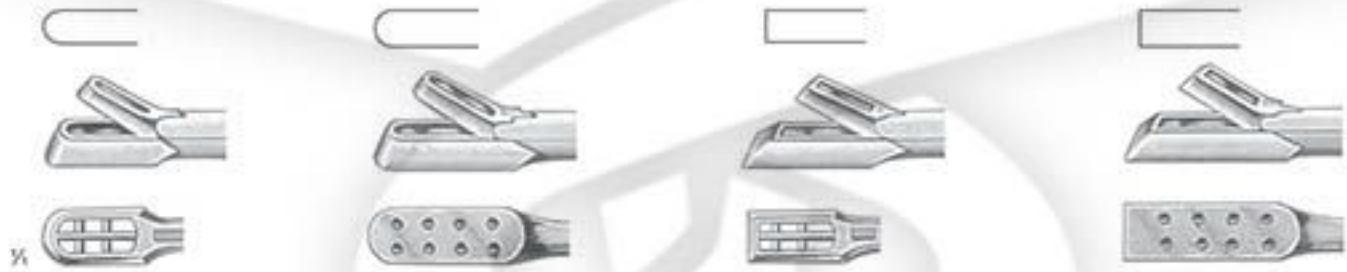
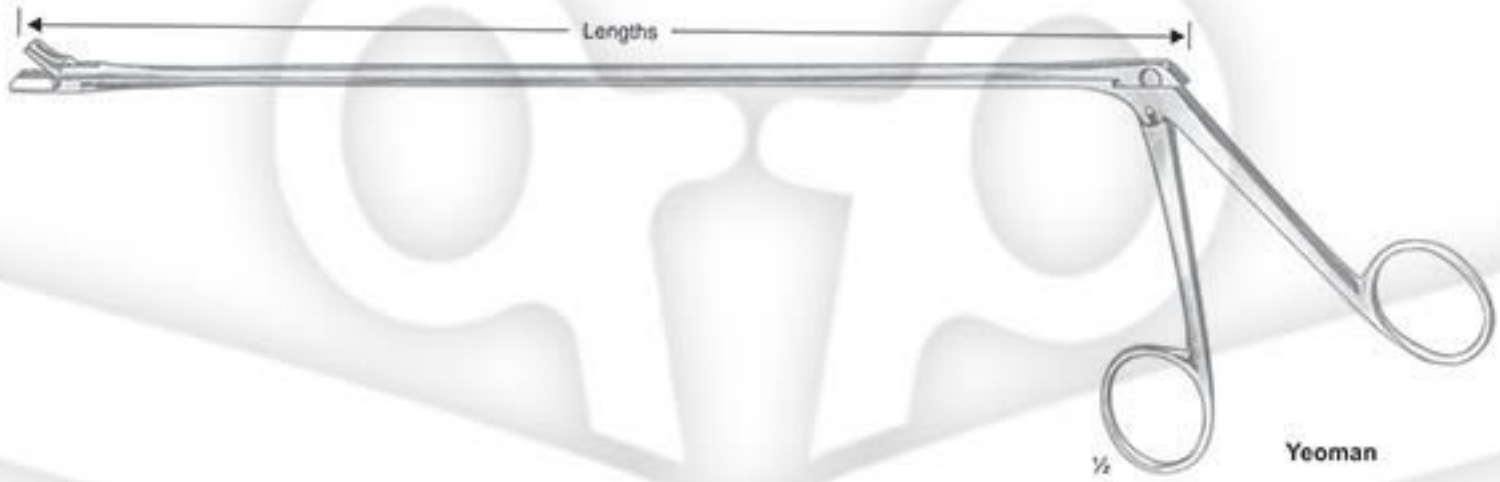

TI-349-2911 - 28.0 cm / 11"
 TI-349-2912 - 35.0 cm / 13 3/4"
 TI-349-2913 - 42.0 cm / 16 1/2"

TI-349-2914 - 28.0 cm / 11"
 TI-349-2915 - 35.0 cm / 13 3/4"
 TI-349-2916 - 42.0 cm / 16 1/2"

TI-349-2917 - 28.0 cm / 11"
 TI-349-2918 - 35.0 cm / 13 3/4"
 TI-349-2919 - 42.0 cm / 16 1/2"

TI-349-2920 - 28.0 cm / 11"
 TI-349-2921 - 35.0 cm / 13 3/4"
 TI-349-2922 - 42.0 cm / 16 1/2"

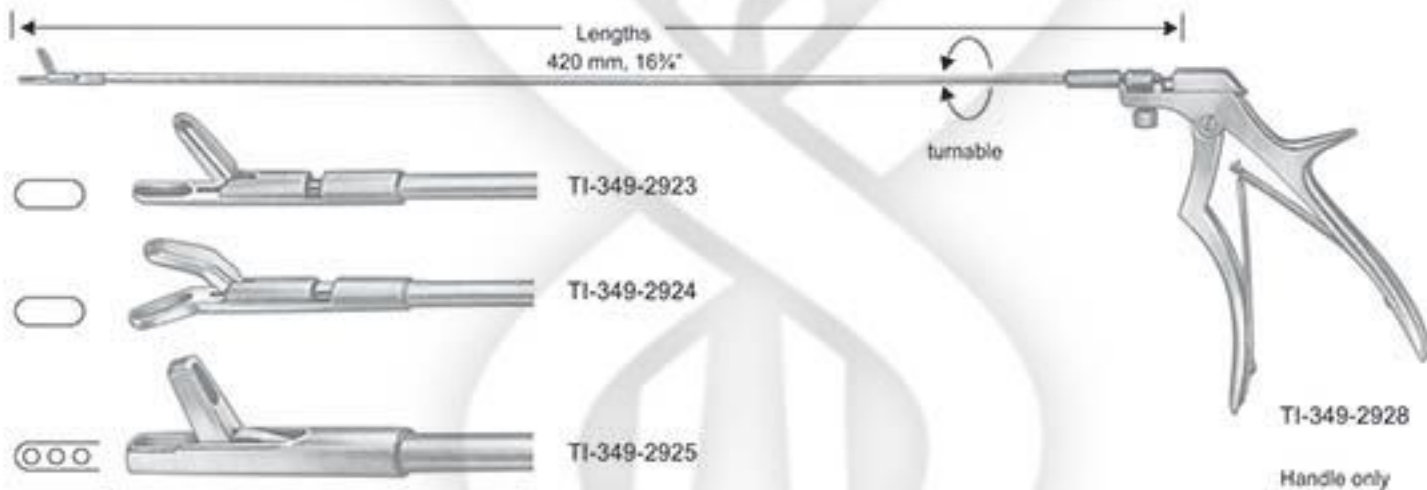

-  TI-349-2923
-  TI-349-2924
-  TI-349-2925
-  TI-349-2926
-  TI-349-2927

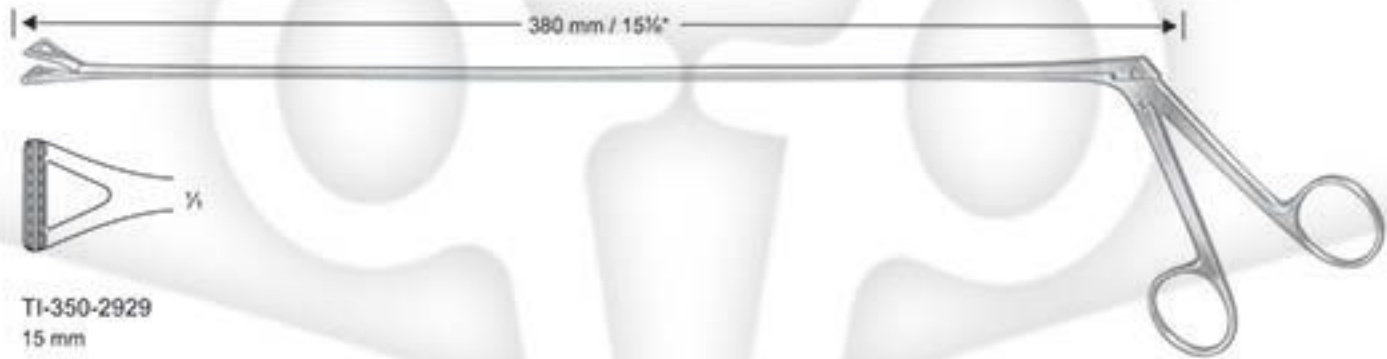

TI-350-2929
15 mm



Luer
TI-350-2930
 24.5 cm / 9 3/4"

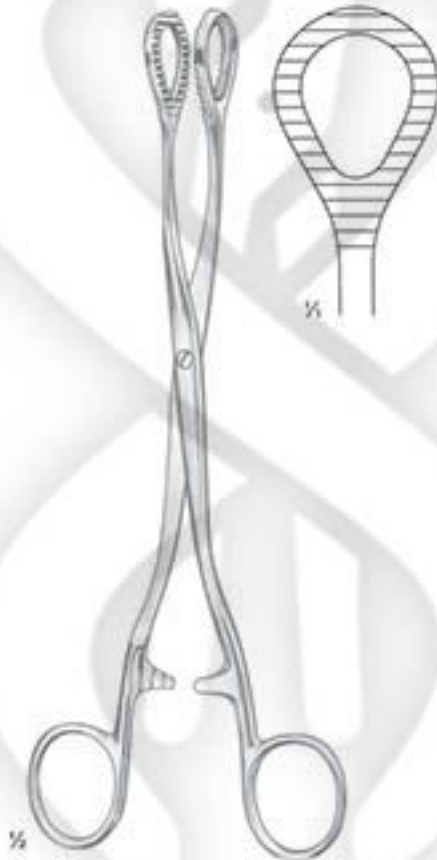

Heywood-Smith
TI-350-2931
 20.0 cm / 8"



Heywood-Smith
TI-350-2932
 21.0 cm / 8 1/4"

12

LIVER, GALL BLADDER
KIDNEY
INSTRUMENTS



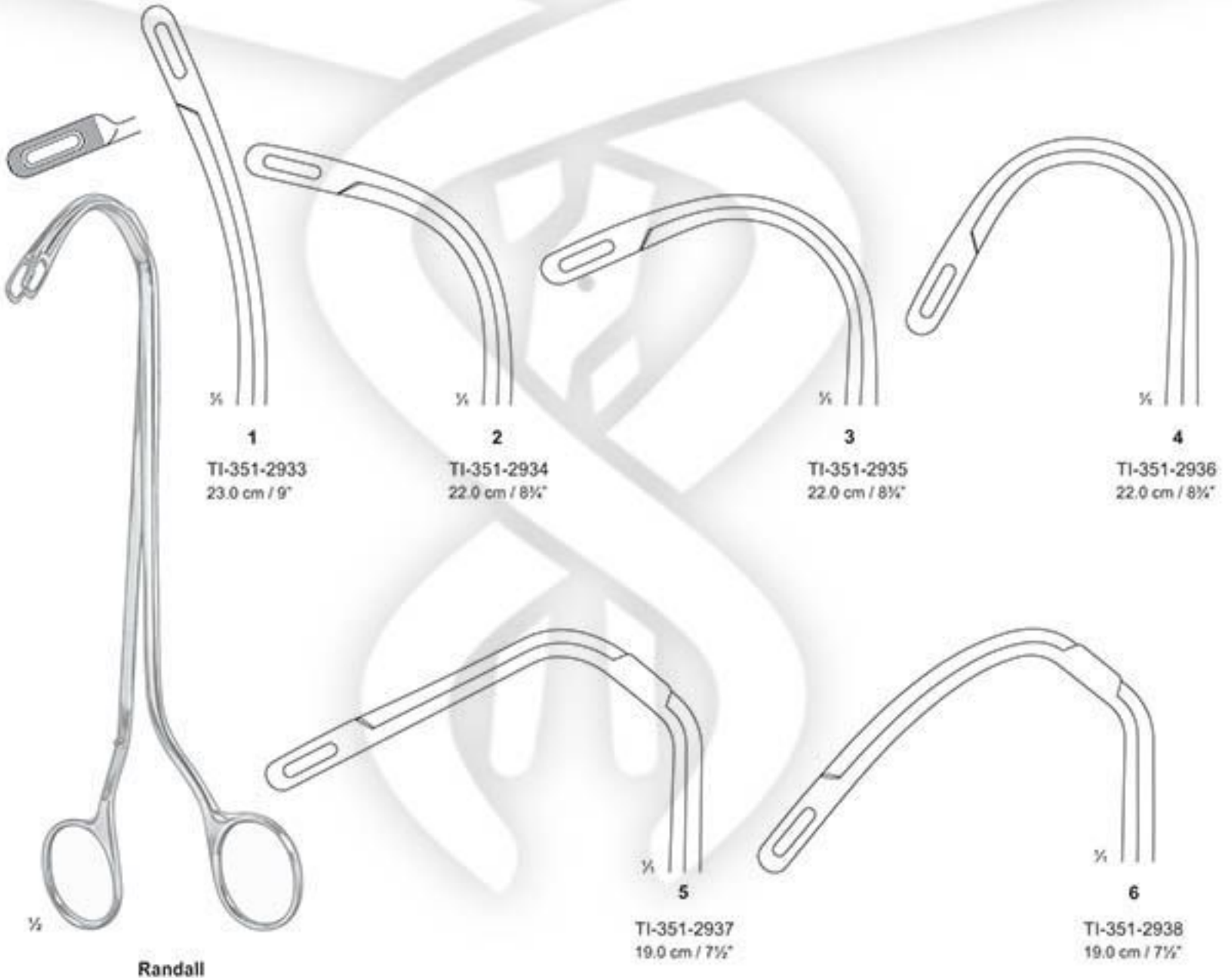

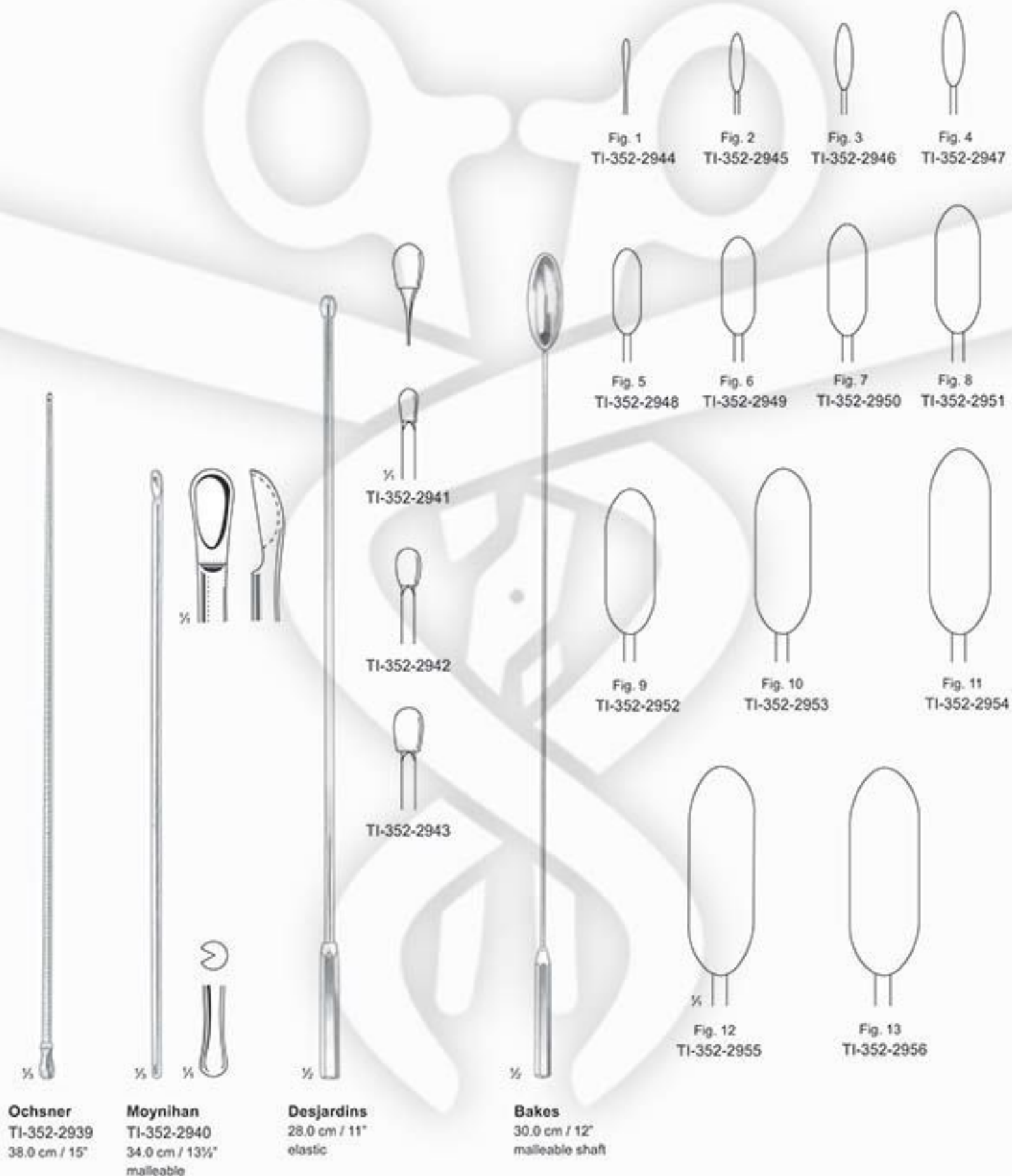

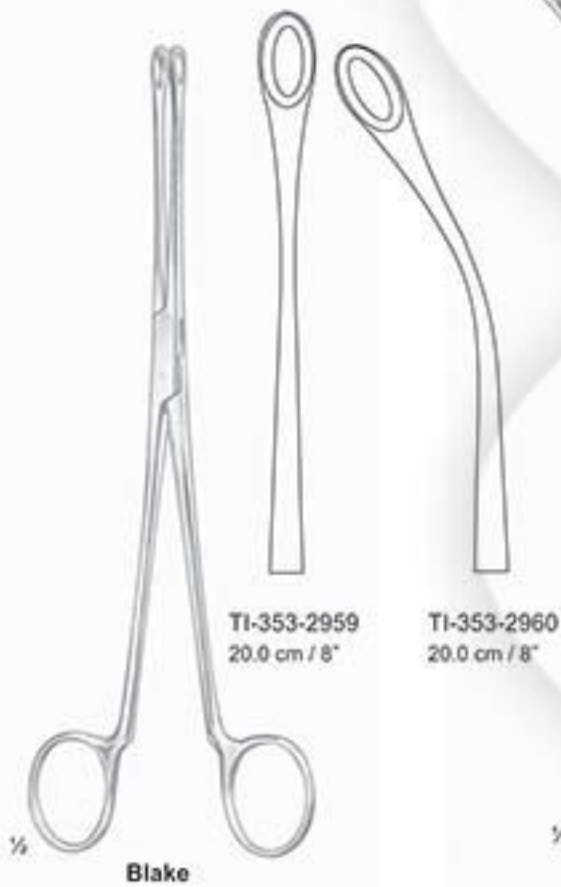

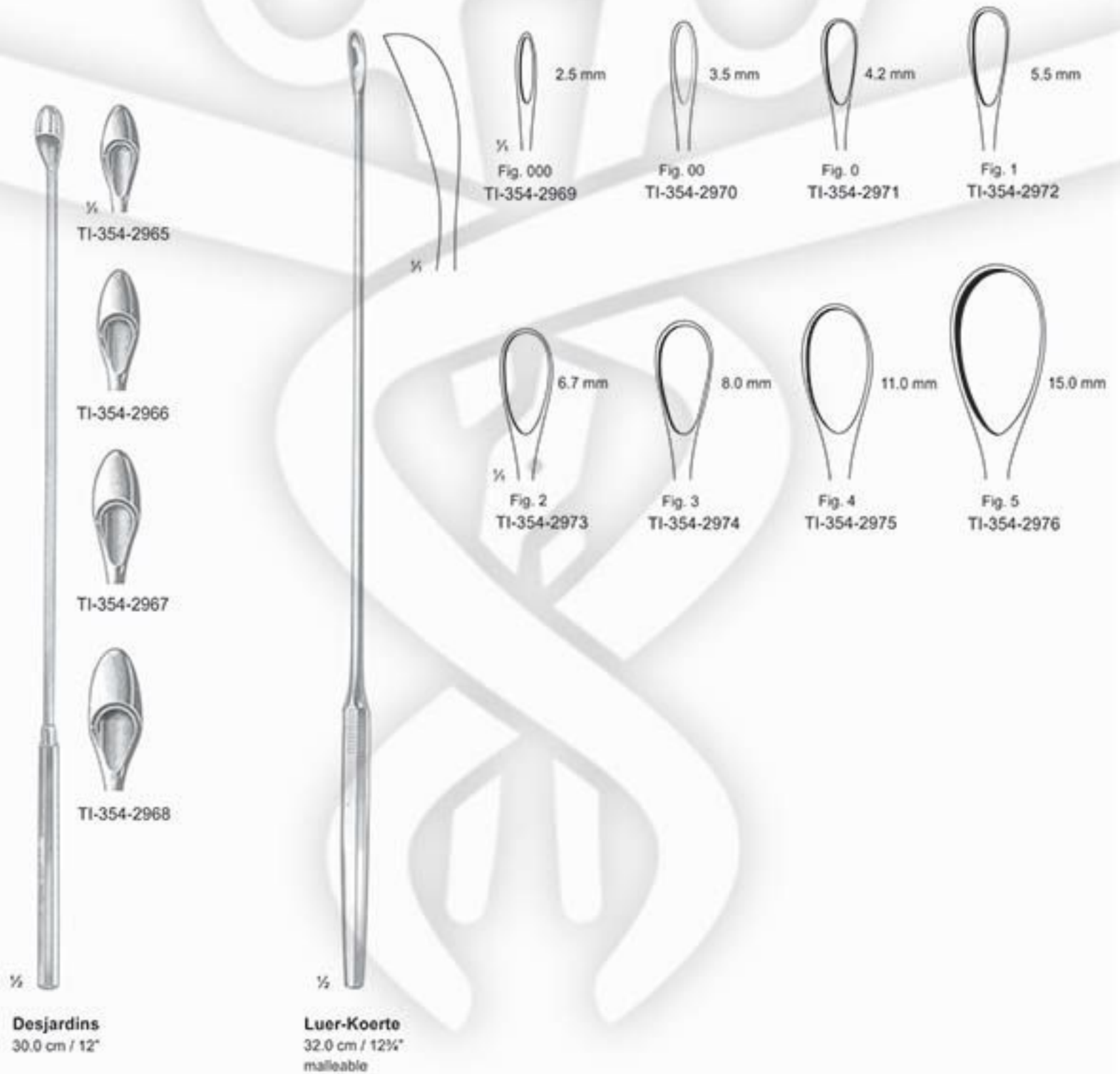



Moore
TI-355-2977
28.0 cm / 11"



Mayo
TI-355-2978
28.0 cm / 11"



TI-355-2979
34.0 cm / 12 1/2"



Fergusson



TI-355-2980
21.5 cm / 8 1/2"

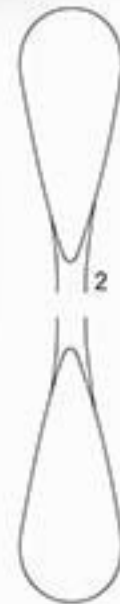

TI-355-2981
22.0 cm / 8 3/4"

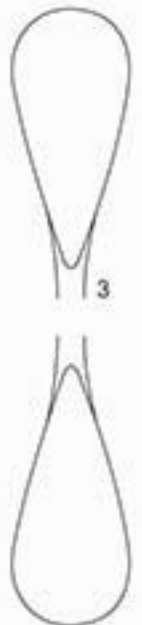

TI-355-2982
23.5 cm / 9 1/4"

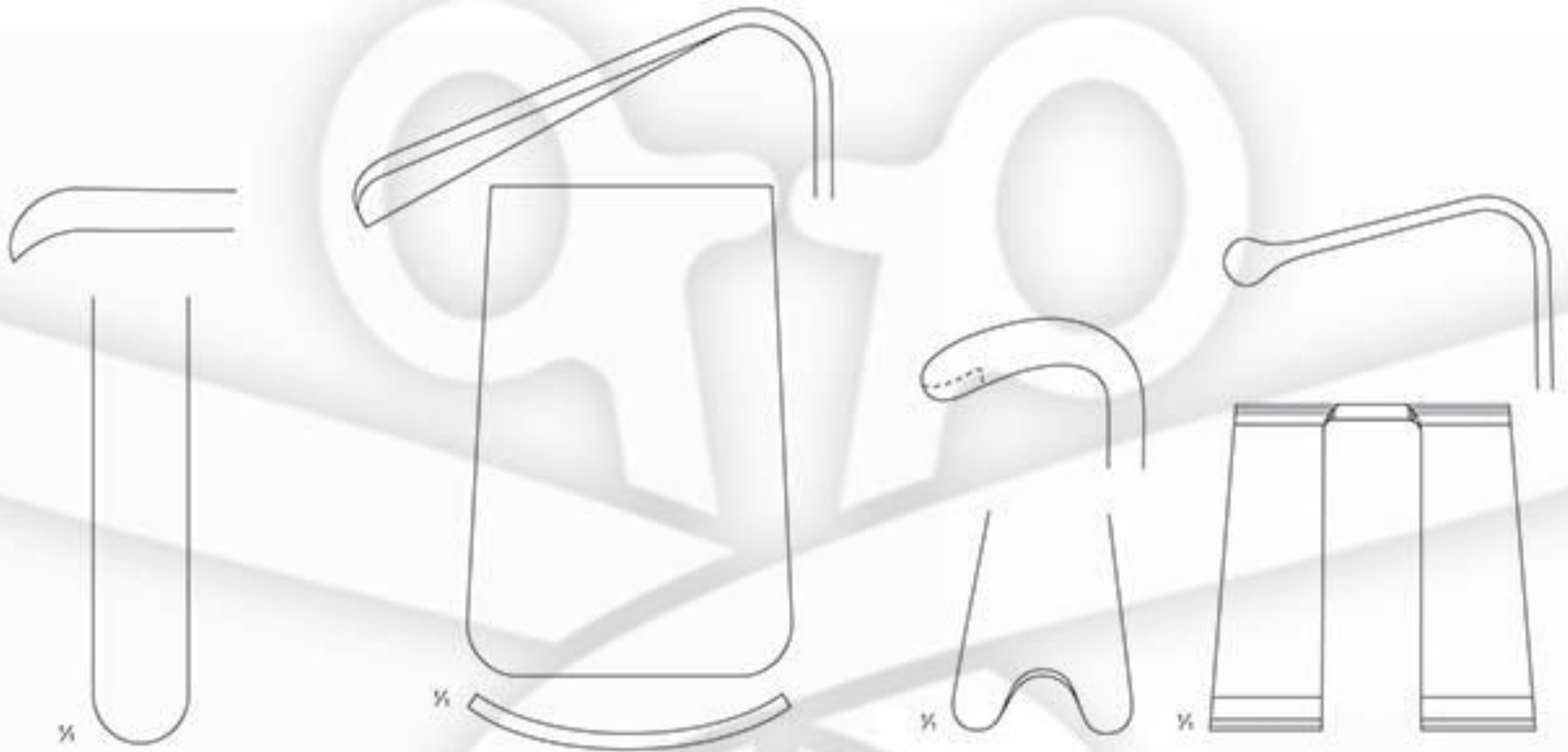

Young
TI-356-2983
21.0 cm / 8 1/4"



Young
TI-356-2984
22.0 cm / 8 3/4"



Young
TI-356-2985
21.0 cm / 8 1/4"



Young
TI-356-2986
22.0 cm / 8 3/4"

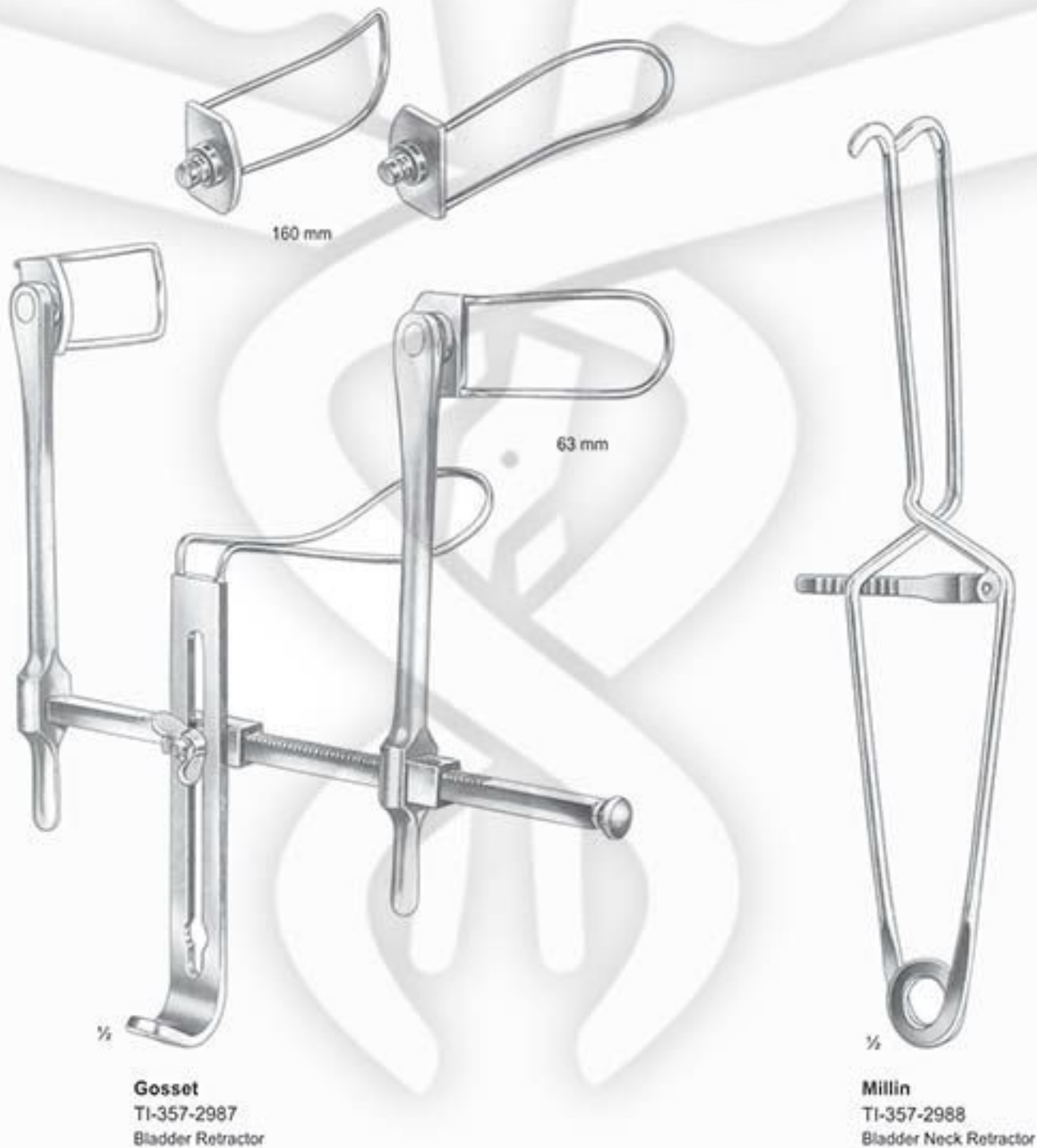

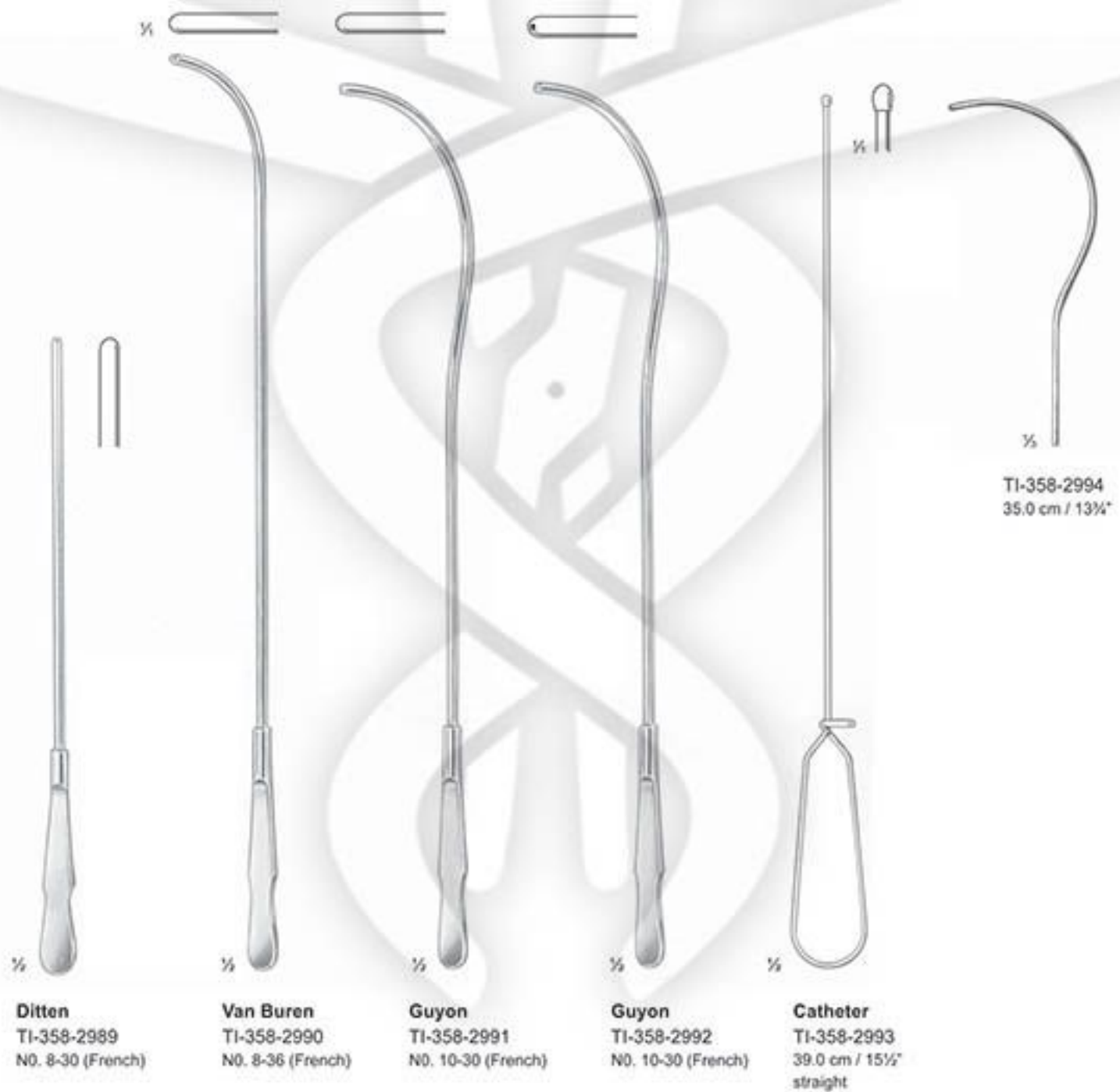

Ditten
TI-358-2989
NO. 8-30 (French)

Van Buren
TI-358-2990
NO. 8-36 (French)

Guyon
TI-358-2991
NO. 10-30 (French)

Guyon
TI-358-2992
NO. 10-30 (French)

Catheter
TI-358-2993
39.0 cm / 15 1/2\"/>

TI-358-2994
35.0 cm / 13 3/4\"/>

13

RECTAL & GENTO-URINARY INSTRUMENTS





Fansler Operating Speculum
TI-359-2995
slotted tube, 2 $\frac{1}{2}$ " long x 1 $\frac{1}{4}$ "
diameter (6cm x 3.2cm)

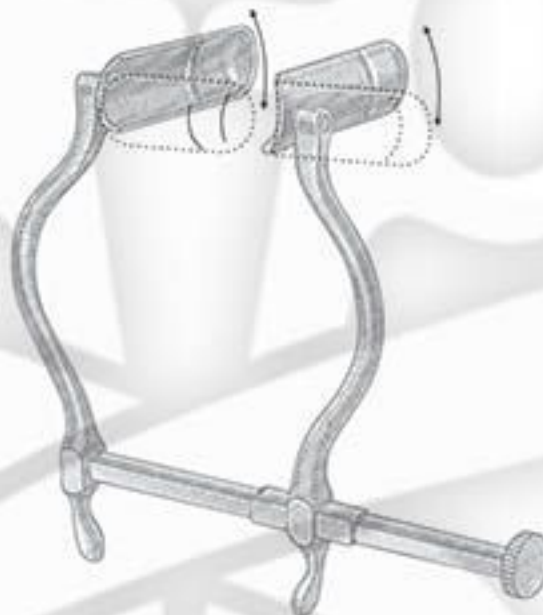

Smith Anal Retractor
TI-359-2996
maximum opening 10.2 cm / 4"
swivel blades 2 $\frac{1}{4}$ " deep x $\frac{3}{8}$ "
wide (7cm x 2.2cm)



Barr Anal Retractor
TI-359-2997
20.0cm/8", self-retaining
blades 2 $\frac{1}{4}$ " deep x $\frac{3}{8}$ "
wide (7cm x 2.2cm)



Pratt Rectal Speculum
TI-359-2998
blades 3 $\frac{1}{2}$ " deep x 1" wide (8.9cm x 2.5cm)
diameter at opening 1 $\frac{1}{4}$ " (4.4cm)



Bodenhammer Rectal Speculum
TI-359-2999
blades 3 $\frac{1}{2}$ " deep x $\frac{3}{4}$ " wide (8.9cm x 1.9cm)
diameter at opening $\frac{3}{8}$ " (2.2cm)



Sims Rectal Speculum
TI-359-3000
blades 3 $\frac{1}{2}$ " deep x $\frac{3}{8}$ " wide (8.9cm x 2.2cm)
diameter at opening $\frac{5}{8}$ " (1.6cm), fenestrated



Fansler (Ives) Rectal Speculum
TI-360-3001
3 $\frac{1}{4}$ " long x 1" diameter (8.3cm x 2.5cm)



Hirschman Anoscopes
TI-360-3007
Small- 2 $\frac{1}{2}$ " long x $\frac{1}{8}$ " diameter (6.4cm x 1.4cm)
TI-360-3008
Medium- 2 $\frac{3}{4}$ " long x $\frac{1}{4}$ " diameter (7cm x 1.7cm)
TI-360-3009
Large- 3 $\frac{1}{2}$ " long x $\frac{1}{2}$ " diameter (8.9cm x 2.2cm)



Chelsea-Eaton Anal Speculum
TI-360-3002
Small- 2 $\frac{1}{2}$ " long x $\frac{1}{8}$ " diameter (6.4cm x 2.2cm)
TI-360-3003
Large- 2 $\frac{1}{2}$ " long x 1 $\frac{1}{8}$ " diameter (6.4cm x 3.1cm)



Brinkerhoff Rectal Specula
TI-360-3010
Small: 3 $\frac{1}{2}$ " long x 1" diameter (8.9cm x 2.5cm), tapering to $\frac{1}{2}$ " (1.3 cm)
TI-360-3011
Medium: 4" long x 1" diameter (10.2cm x 2.5cm), tapering to $\frac{3}{4}$ " (1.6cm)
TI-360-3012
Large: 4 $\frac{1}{2}$ " long x 1 $\frac{1}{2}$ " diameter (12.1cm x 3.2cm), tapering to $\frac{3}{4}$ " (1.9cm)



Kelly Proctoscopes $\frac{1}{8}$ " diameter (2.2cm)
TI-360-3004- Small: long (5.1cm / 2")
TI-360-3005- Medium: long (10.2cm / 4")
TI-360-3006- Large: long (14.0cm / 5 $\frac{1}{2}$ ")



Kelly Sphincteroscope
TI-360-3013
diameter (5.1cm x 2.5cm), tapering to $\frac{1}{8}$ " (2.1cm)

**Hill-Ferguson Rectal Retractors**

TI-361-3014- Small: 2½" x ¾" wide (6.4cm x 2.2cm) blade

TI-361-3015- Large: 3" x 1⅞" wide (7.6cm x 3cm) blade

TI-361-3016- Large: 3" x 1⅞" wide (7.6cm x 3.6cm) blade

**Sawyer Rectal Retractors**

TI-361-3017- Small: 2½" x ¾" wide (6.4cm x 2.2cm) blade

TI-361-3018- Medium: 3" x ⅝" wide (7.6cm x 2.9cm) blade

TI-361-3019- Large: 3½" x 1⅞" wide (8.9cm x 3.8cm) blade

14

TRACHEOTOMY INSTRUMENTS



TALC INDUSTRIES
ONE STOP FOR MEDICAL EQUIPMENT





Laborde
TI-362-3020
14.0 cm / 5 1/2"

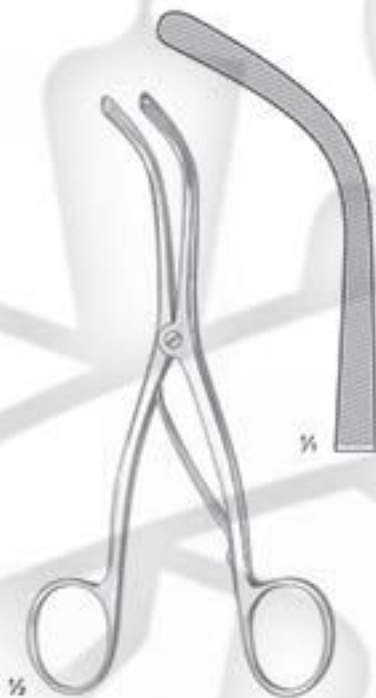

Trousseau
TI-362-3021
14.0 cm / 5 1/2"



Bose
TI-362-3022
7.0 cm / 2 1/2"

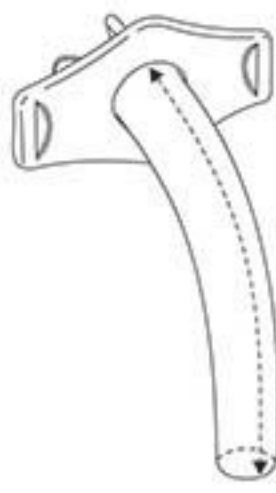

Jackson-Trachea Tubes

International Scale	TI-362-3023	TI-362-3024	TI-362-3025	TI-362-3026	TI-362-3027	TI-362-3028	TI-362-3029	TI-362-3030	TI-362-3031	TI-362-3032
Figure	0	1	2	3	4	5	6	7	8	9
Diameter	4	5	6	7	8	9	10	11	12	13mm
Length of outer tube	45	50	55	60	65	70	75	80	85	90 mm

Length
from shield along outer curvature to end of tube

Diameter (ø)
at the end of the outer tube in millimeters

15

GYNECOLOGY INSTRUMENTS





1/2
Metal Specula, tubular shape



1/2
Fergusson
TI-363-3033 - 25 mm ø
TI-363-3034 - 30 mm ø
TI-363-3035 - 35 mm ø



1/2
Collin
TI-363-3036
55 x 10 mm



1/2
Cusco
TI-363-3037 - 75 x 32 mm
TI-363-3038 - 85 x 35 mm
TI-363-3039 - 100 x 35 mm
Vaginal Specula with lateral ratchet, with folding handles.

1/2
TI-363-3040 - 85 x 35 mm
with interchangeable fiber optic light carrier
fiber optic light carrier



1/2
Cusco
TI-363-3041
75 x 17 mm
conical shape, virgin size

Cusco

- TI-364-3042 - 80 x 22 mm
- TI-364-3043 - 100 x 25 mm
- TI-364-3044 - 105 x 27 mm

Swiss pattern, narrow, with lateral ratchet, with folding handles



Cusco

- TI-364-3045 - 75 x 32 mm
- TI-364-3046 - 85 x 35 mm
- TI-364-3047 - 100 x 37 mm

with ratchet at the folding handles



Collin
TI-364-3048
65 x 20 mm

Collin

- TI-364-3049 - 85 x 30 mm
- TI-364-3050 - 100 x 35 mm
- TI-364-3051 - 110 x 40 mm
- TI-364-3052 - 100 x 35 mm

Detachable
with interchangeable fibere optic light carrier

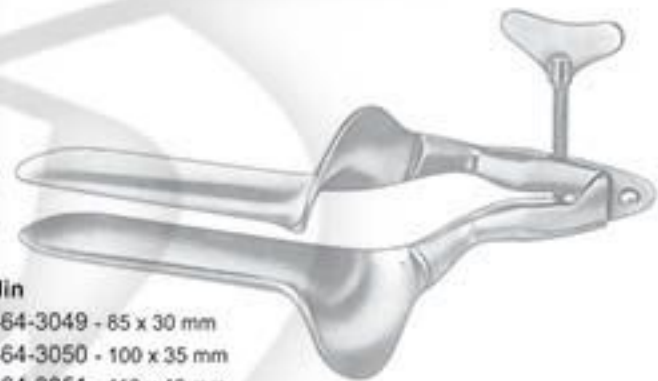

Collin-Lanau
TI-364-3053
100 x 35 mm

Trelat

- TI-364-3054 - 85 x 33 mm
- TI-364-3055 - 95 x 35 mm
- TI-364-3056 - 115 x 43 mm

detachable, with folding handles

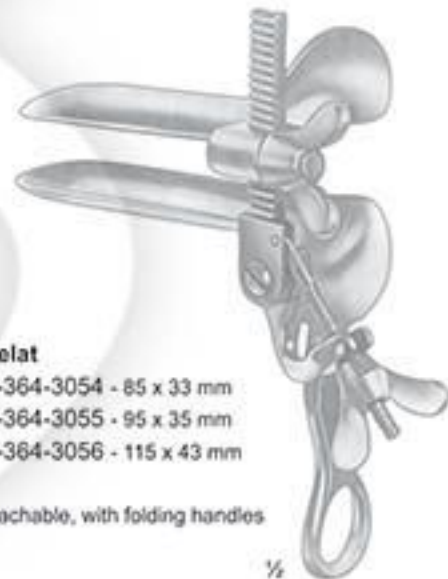

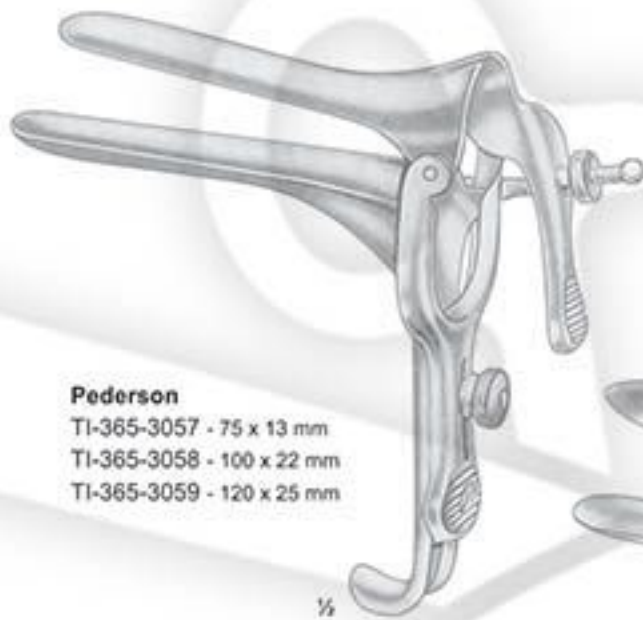

Pederson
TI-365-3057 - 75 x 13 mm
TI-365-3058 - 100 x 22 mm
TI-365-3059 - 120 x 25 mm



Graves
TI-365-3060 - 75 x 20 mm
TI-365-3061 - 95 x 35 mm
TI-365-3062 - 115 x 35 mm

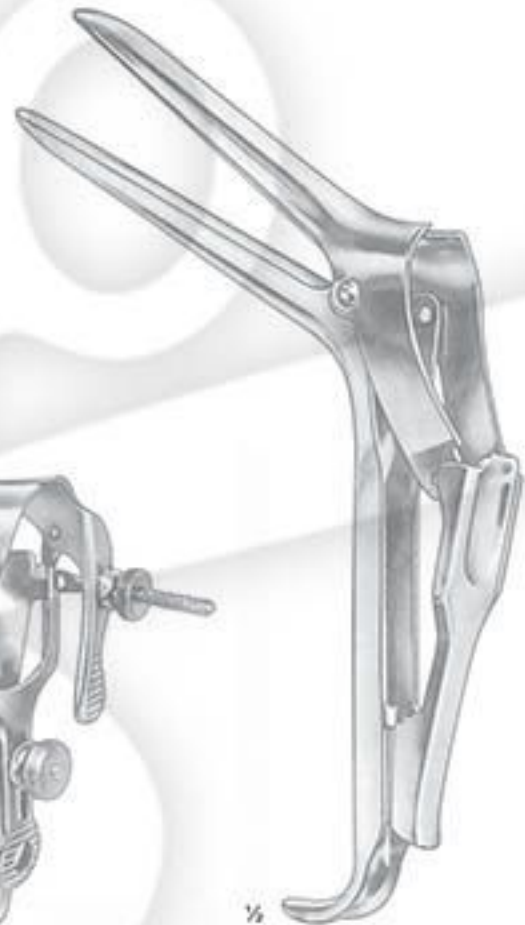

Semm
TI-365-3063 - 100 x 17/20 mm
TI-365-3064 - 100 x 25/30 mm



Kristeller Specula
Fig.1 TI-365-3065 - 70 x 27 mm
Fig.2 TI-365-3066 - 80 x 30 mm
Fig.3 TI-365-3067 - 90 x 36 mm



Kristeller Retractors
Fig.1 TI-365-3068 - 75 x 23 mm
Fig.2 TI-365-3069 - 85 x 26 mm
Fig.3 TI-365-3070 - 100 x 32 mm



Kristeller
set of 1 speculum
and 1 retractor each
Fig.1 TI-365-3071
Fig.2 TI-365-3072
Fig.3 TI-365-3073

Sims

- TI-366-3074 - 65 x 25 mm
- 70 x 30 mm
- 70 x 30 mm
- TI-366-3075 - 70 x 35 mm
- 85 x 35 mm
- TI-366-3076 - 90 x 40 mm

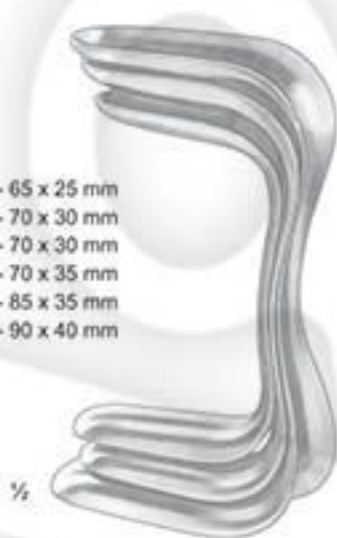

Jackson

- TI-366-3077 - 75 x 35 mm
- TI-366-3078 - 90 x 35 mm
- TI-366-3079 - 100 x 35 mm
- TI-366-3080 - 75 x 40 mm
- TI-366-3081 - 90 x 40 mm
- TI-366-3082 - 100 x 40 mm



with conically shaped blades, virgin sizes



1/2

Kristeller Specula

- TI-366-3083 - 105 x 18 mm
- TI-366-3084 - 105 x 21 mm



1/2

Kristeller Retractors

- TI-366-3085 - 110 x 14 mm
- TI-366-3086 - 110 x 17 mm



1/2

Kristeller

- Set of 1 Speculum and 1 Retractors
- TI-366-3087
- TI-366-3088

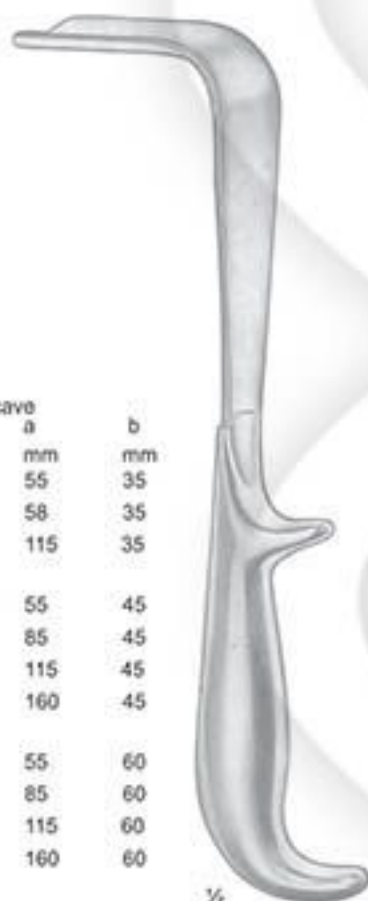
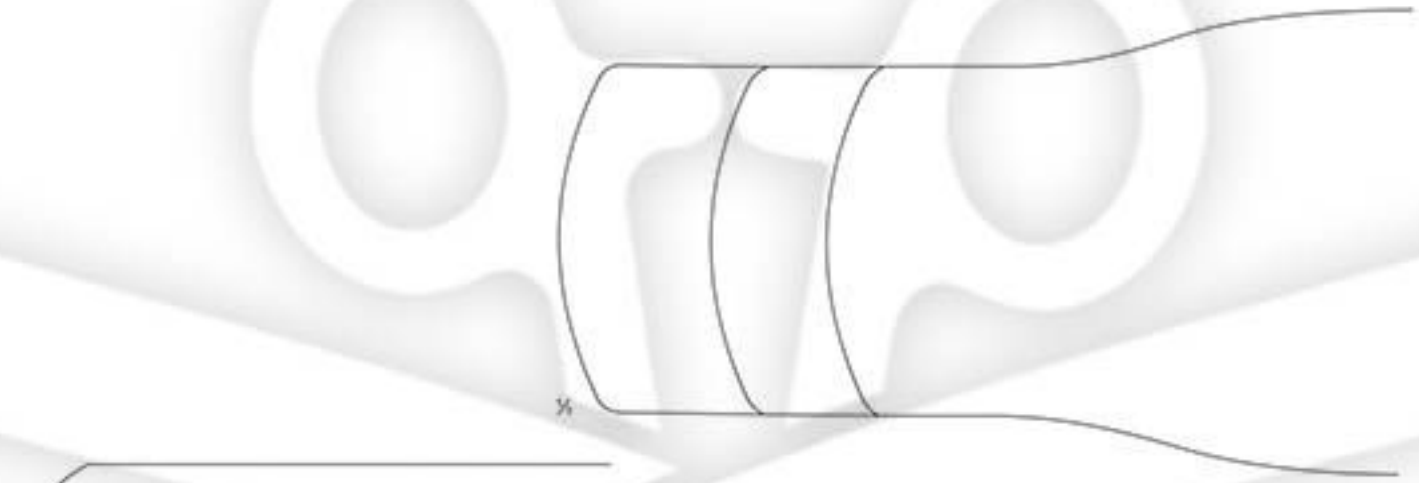

Doyen



1/4

Doyen

Fig.		slightly-concave a mm	b mm
1	TI-367-3089	55	35
2	TI-367-3090	58	35
3	TI-367-3091	115	35
1	TI-367-3092	55	45
2	TI-367-3093	85	45
3	TI-367-3094	115	45
4	TI-367-3095	160	45
1	TI-367-3096	55	60
2	TI-367-3097	85	60
3	TI-367-3098	115	60
4	TI-367-3099	160	60

Fig.		a mm	b mm
1	TI-367-3100	75	45
2	TI-367-3101	90	45
3	TI-367-3102	110	45



Samuel
TI-368-3103
complete, with removable weight and
metal strainer with perforated
bottom for retaining specimen

Samuel
TI-368-3104
metal strainer with
perforated bottom only

Auvard
TI-368-3105
complete, with removable weight

70 x 30 mm



1/2

Doyen Vaginal Speculum
TI-369-3106
24.0 cm / 9 1/2"



1/2

O'Sullivan-O'Connor
TI-369-3107

Vaginal Speculum, for examination and operative work, self-retaining, with adjustable frame, Lokite ratchet, 2 mobile lateral blades and interchangeable blades fig. 1-3.

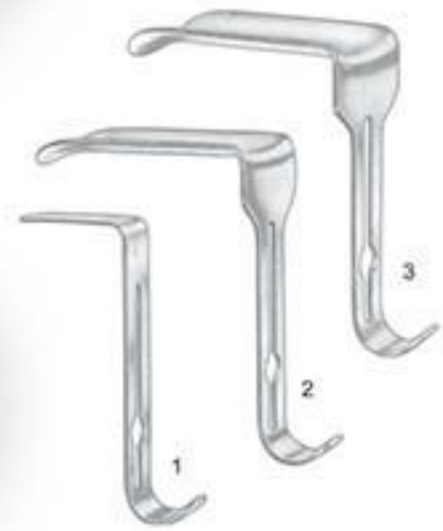

Fig. 1 = 45 x 17 mm
Fig. 2 = 90 x 37 mm
Fig. 3 = 90 x 45 mm



Friedman
TI-370-3108
10.0 cm / 4"

Retractor, self-retaining, for perineorhaphy



Kogan
TI-370-3109
24.0 cm / 9½"

without ratchet



Kogan
TI-370-3110
24.0 cm / 9½"

with scale-ratchet and fixing screws



½

Pieces per set

14	4.0-17.0	TI-371-3111
26	1.0-26.0	TI-371-3112



TI-372-3113
set of 14 dilators
(4.0-17.0 mm ø), in metal case with hinged lid

TI-372-3114
set of 26 dilators
(1.0-26.0 mm ø), in metal case with hinged lid



1/2



1/2

TI-372-3115
set of 8 Dilator
(3.0/4.0 - 17.0/18.0 mm ø)

TI-372-3116
set of 13 Dilator
(1.0-2.0-25.0/26.0 mm ø)



TI-373-3117
set of 8 dilators
(3.0/4.0-17.0/18.0 mm),
in boilable canvas roll

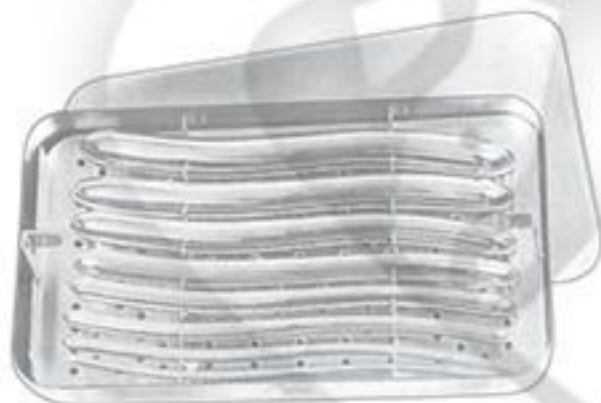

TI-373-3118
set of 8 dilators
(3.0/4.0-17.0/18.0 mm ø,
in metal case with hinged lid



TI-373-3119
set of 13 dilators
(1.0/2.0-25.0/26.0 mm ø,
in metal case with hinged lid



malleable

malleable

Sims
 TI-374-3120
 32.0 cm / 12½"

Special Model
 TI-374-3121
 32.0 cm / 12½"

Strong pattern

Staude-Moore
 TI-374-3122
 17.0 cm / 6¾"

Barrett
 TI-374-3123
 18.0 cm / 7"

Pozzi
 TI-374-3124
 25.5 cm / 10¼"



Schroeder
TI-375-3125
25.0 cm / 10"



Braun
TI-375-3126
25.0 cm / 10"



Duplay
TI-375-3127
28.0 cm / 11"

Amniotome for the amnion bladder



1/2

Beacham
TI-376-3128
26.0 cm / 10 1/4"



1/2

Skene
TI-376-3129
24.0 cm / 9 1/4"

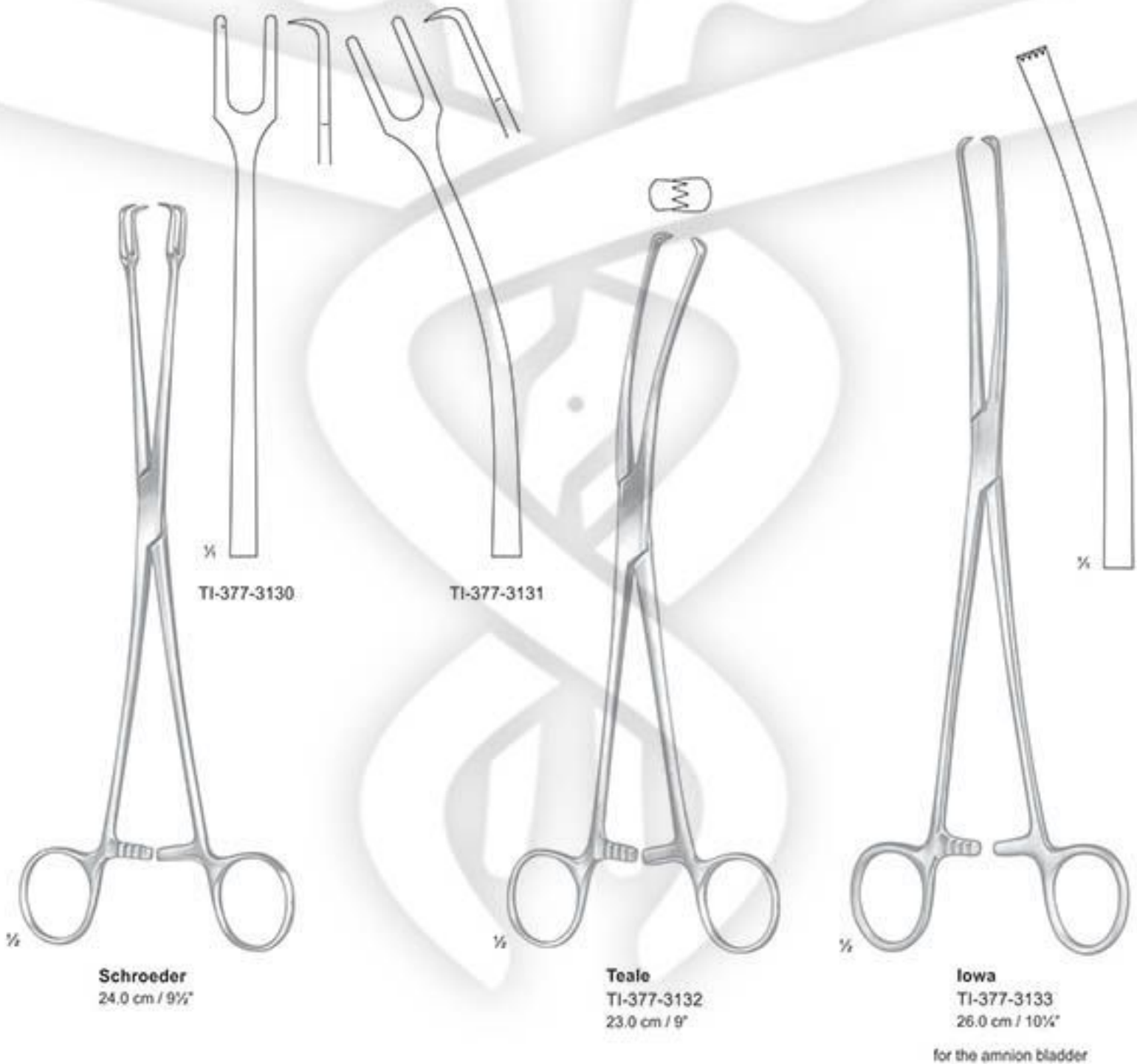



Museux
24.0 cm / 9 1/2"

- | | | | |
|---|--|--|--|
|  |  |  |  |
| | 6 mm | 8 mm | 10 mm |
| | TI-378-3134 | TI-378-3135 | TI-378-3136 |



Museux
24.0 cm / 9 1/2"
curved sideways

- | | | |
|---|--|--|
|  |  |  |
| | 6 mm | 8 mm |
| | TI-378-3137 | TI-378-3138 |





TI-380-3141
26.0 cm / 10 $\frac{1}{4}$ "



Braun
TI-380-3142
16.0 cm / 6 $\frac{1}{4}$ "



Czerny
TI-380-3143
21.0 cm / 8 $\frac{1}{4}$ "



Kelly
TI-381-3144
32.0 cm / 12½"

Noto
TI-381-3145
27.0 cm / 10½"

Doyen
TI-381-3146
20.0 cm / 8"



Doyen
TI-382-3147
17.0 cm / 6 3/4"



Doyen
TI-382-3148
17.0 cm / 6 3/4"

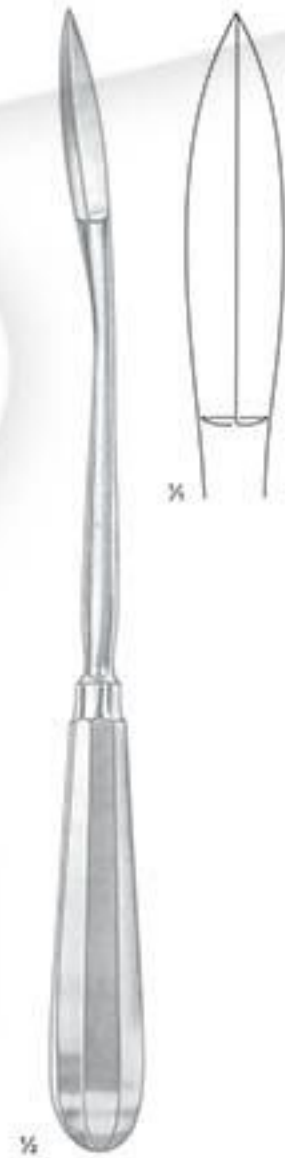

Segond
TI-382-3149



Dartingues
TI-383-3150
27.0 cm / 10½"

Somer
TI-383-3151
23.0 cm / 9"

Collin
TI-383-3152
25.0 cm / 10"

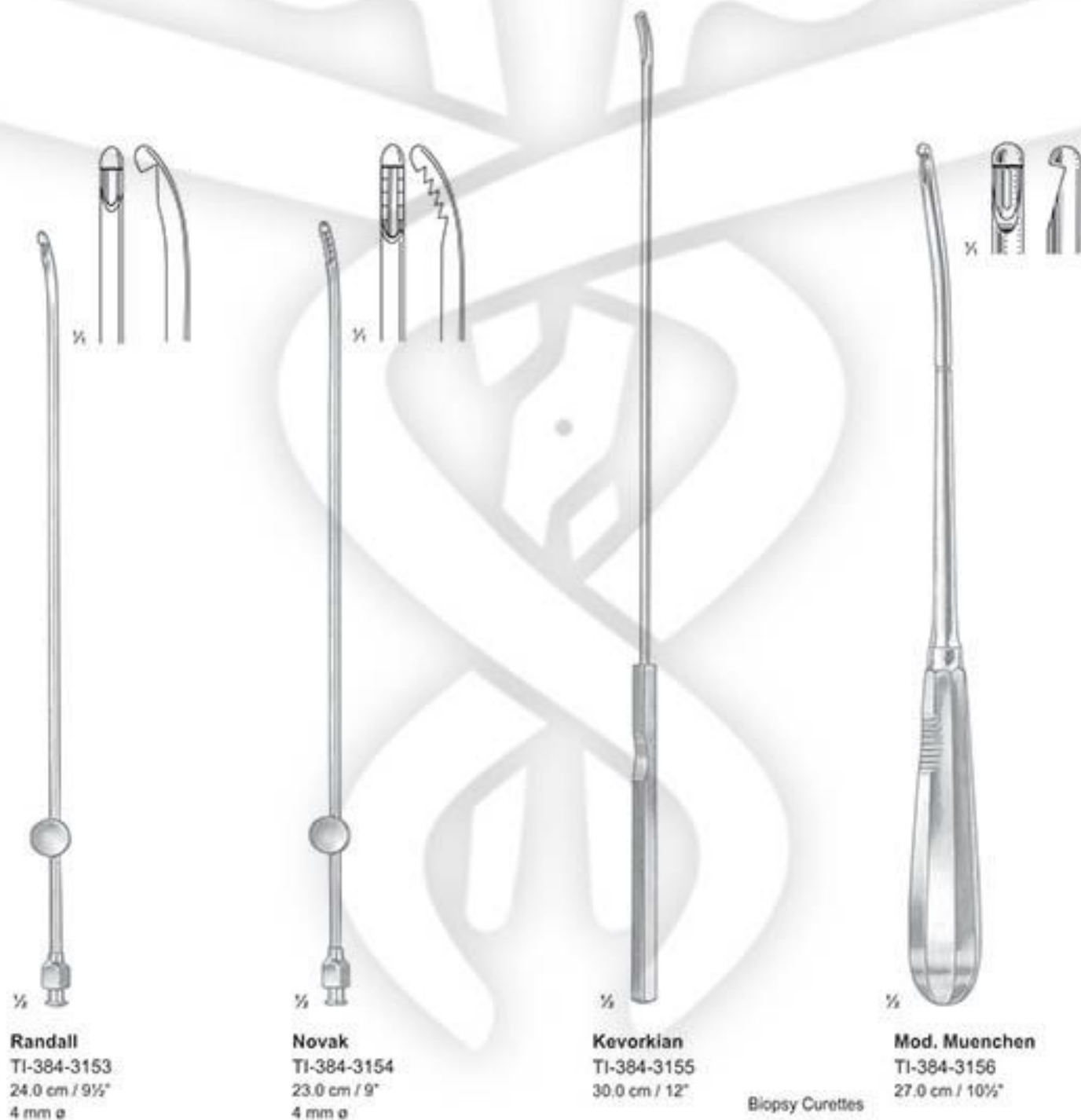

Randall
TI-384-3153
24.0 cm / 9½"
4 mm ø

Novak
TI-384-3154
23.0 cm / 9"
4 mm ø

Kevorkian
TI-384-3155
30.0 cm / 12"

Mod. Muenchen
TI-384-3156
27.0 cm / 10½"

Biopsy Curettes

Endometrial Suction Biopsy Curettes

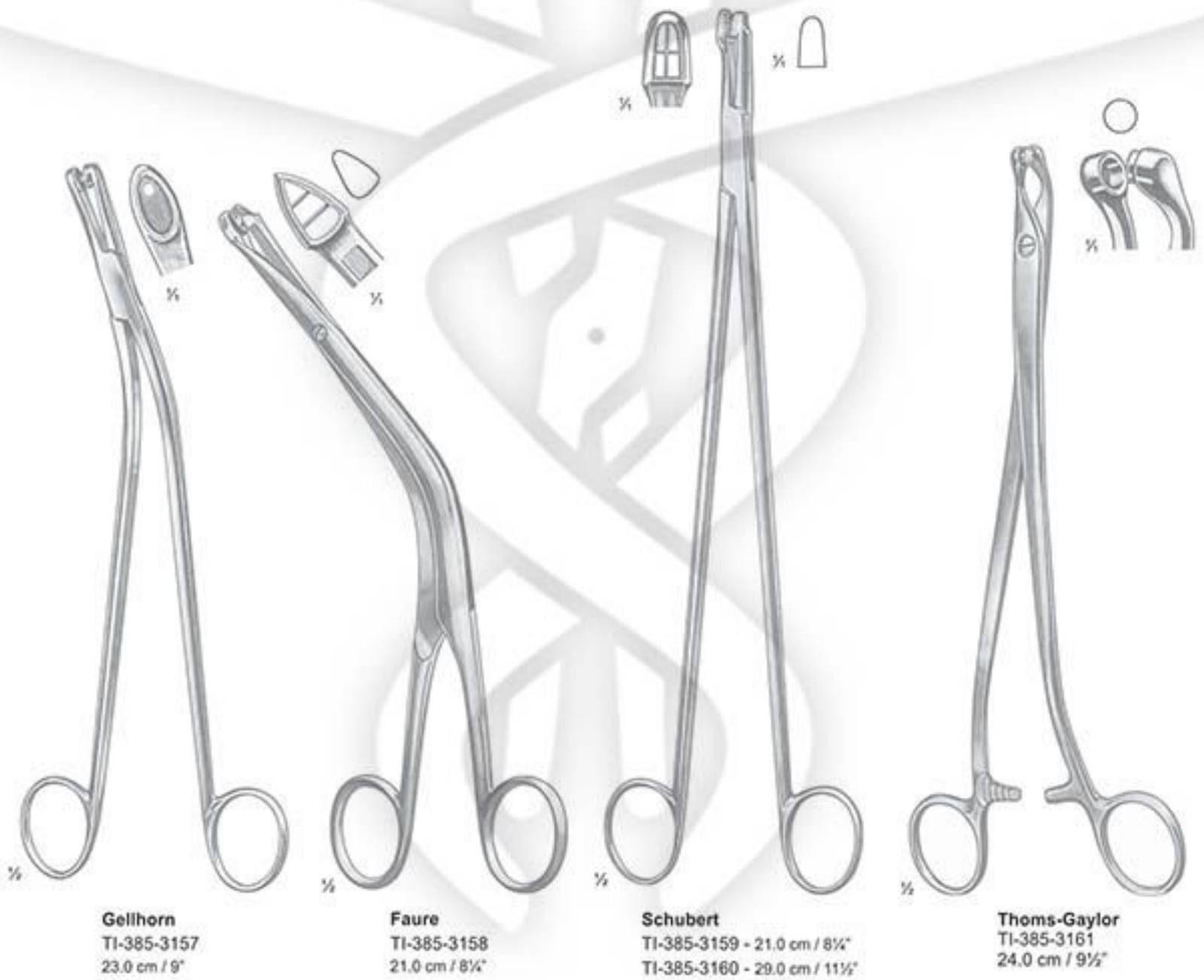

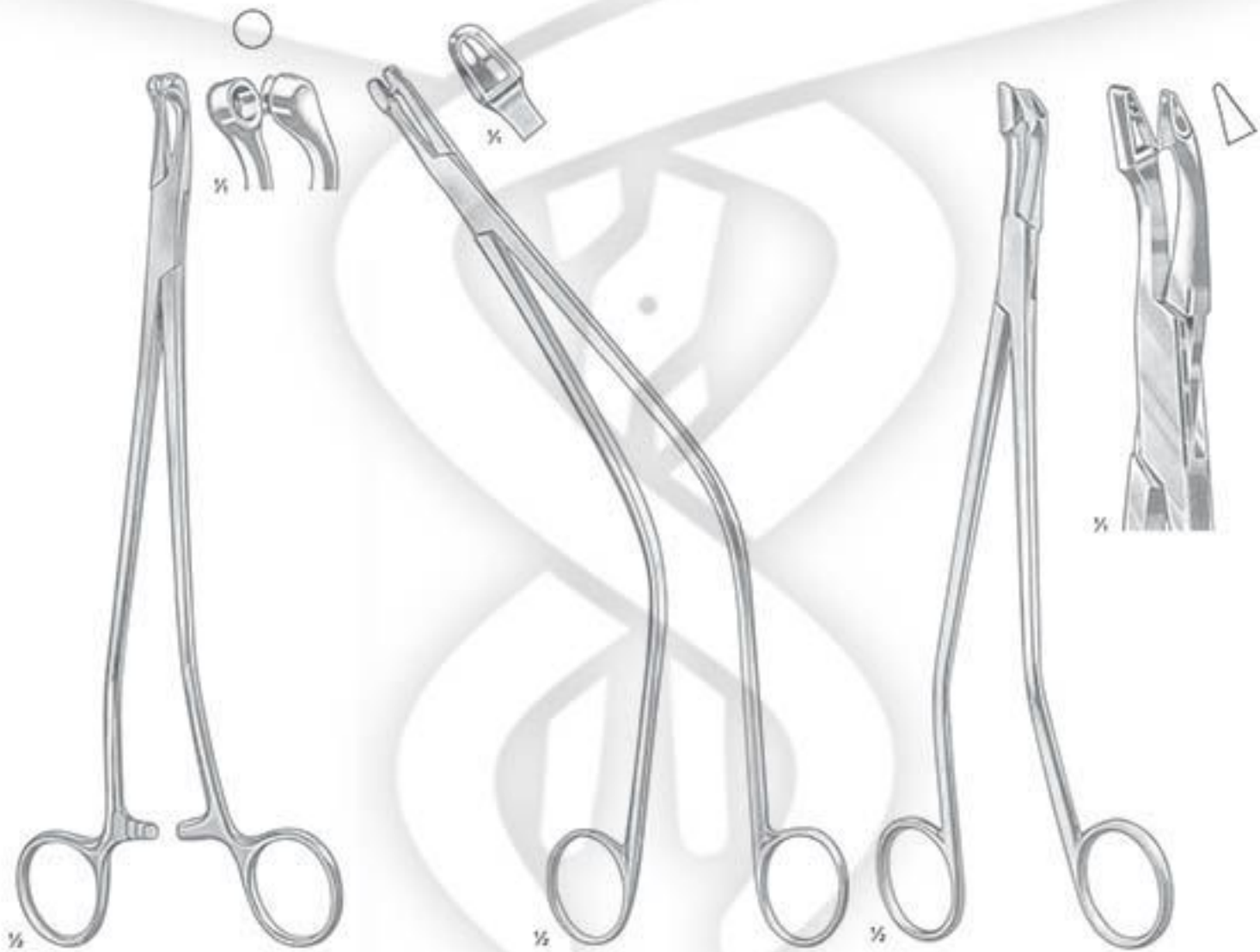

Thoms-Gaylor
TI-386-3162 - 22.0 cm / 8½"
TI-386-3163 - 24.0 cm / 9½"

Schubert
TI-386-3164
26.0 cm / 10¼"

Van Doren
TI-386-3165
24.0 cm / 9½"

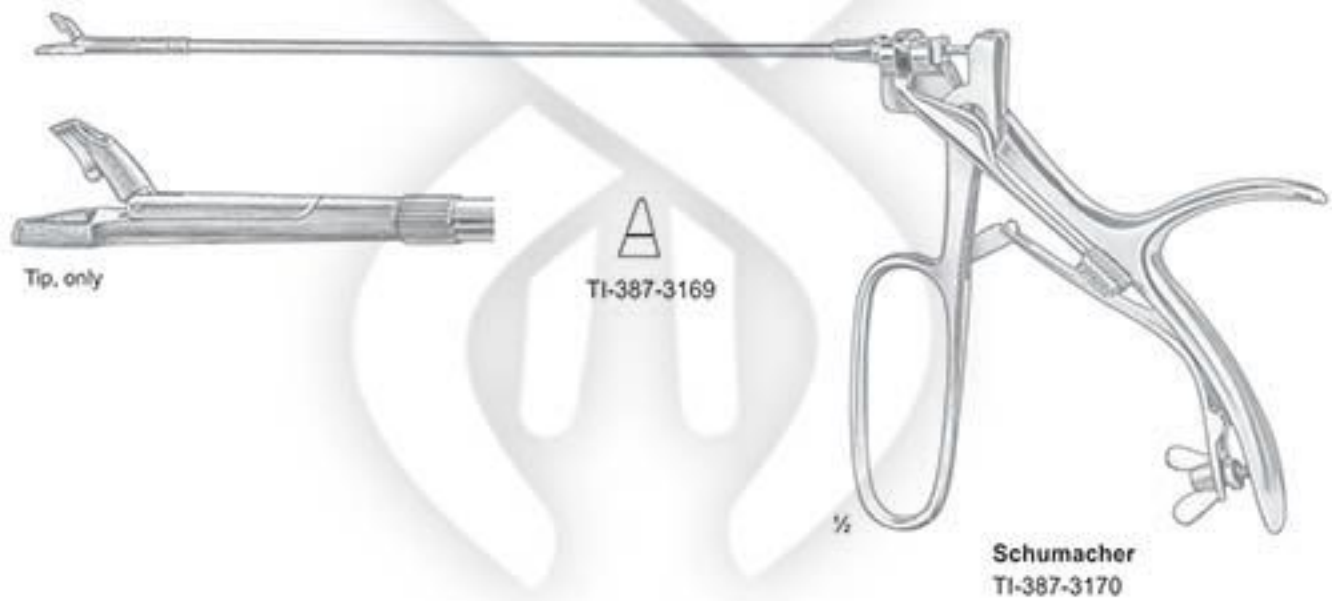
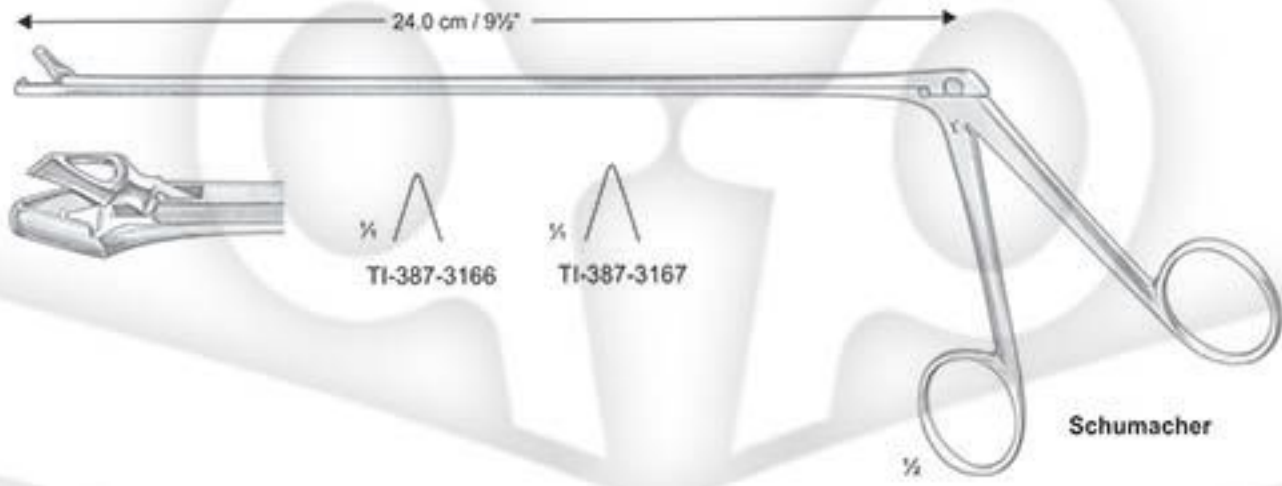

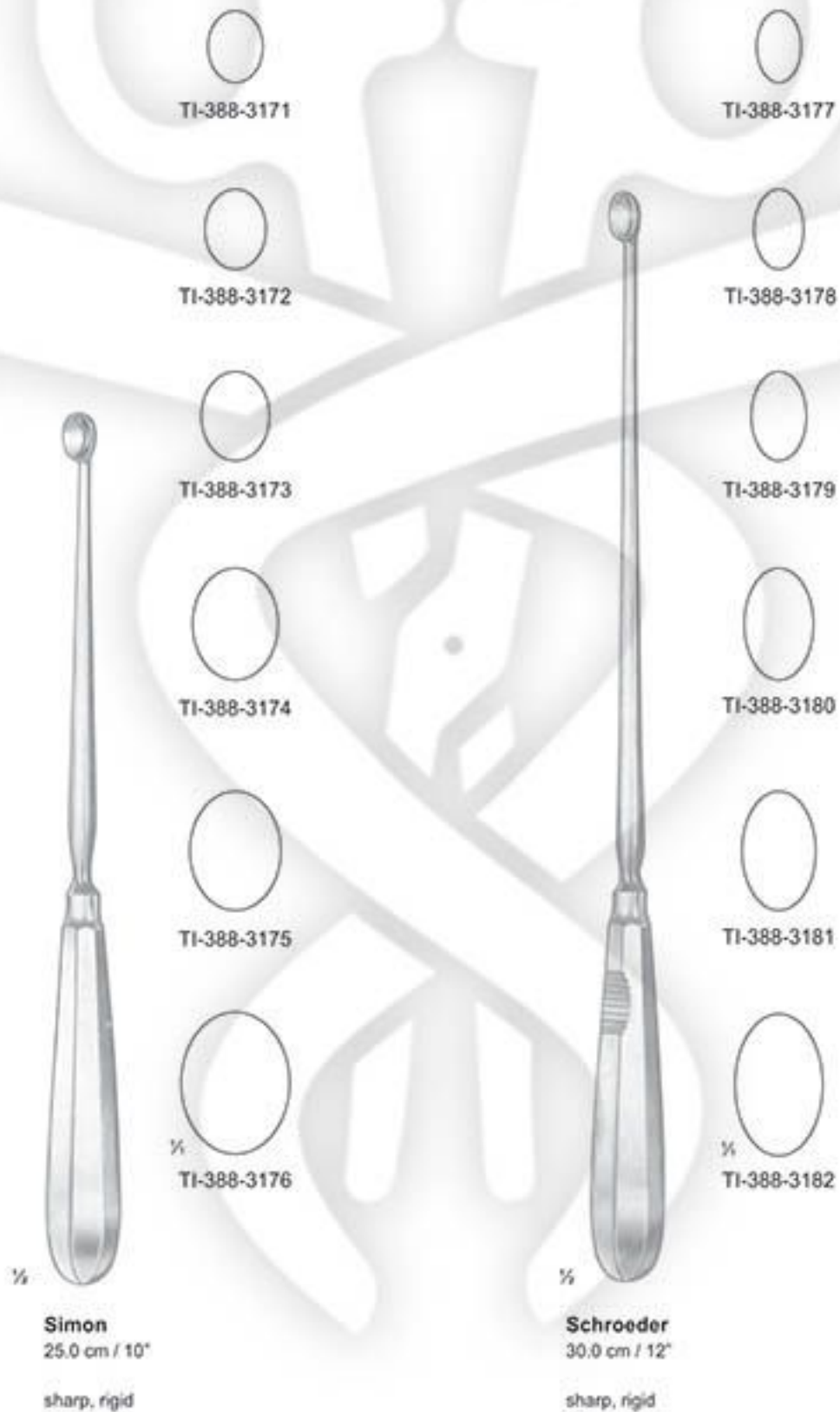



Recamier-Sims-Bumm
TI-389-3183
31.0 cm / 12½"
Fig. 00-16
rigid

Recamier-Sims-Bumm
TI-389-3184
31.0 cm / 12½"
Fig. 00-16
malleable

Recamier-Sims-Bumm
TI-389-3185
31.0 cm / 12½"
Fig. 00-16
rigid

Recamier-Sims-Bumm
TI-389-3186
31.0 cm / 12½"
Fig. 00-16
rigid



Sharp Curettes
(Recamier Handle)



Malleable Curettes
(grooved shaft)



Rigid Curettes
(plain shaft)



Blunt Curettes
(Sims Handle)

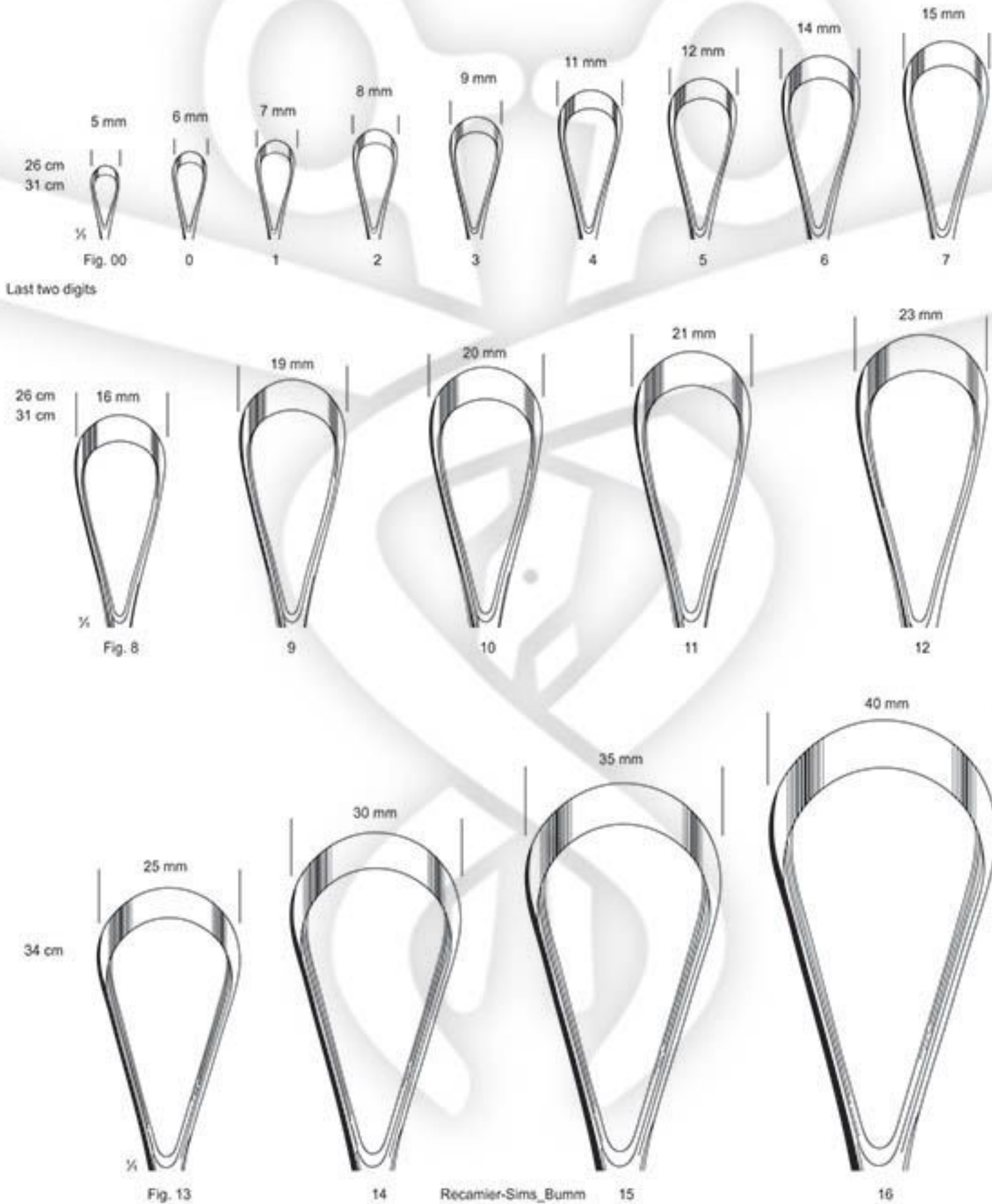



Special Model
TI-391-3187
34.0 cm / 13 1/2"
cm/inch scale

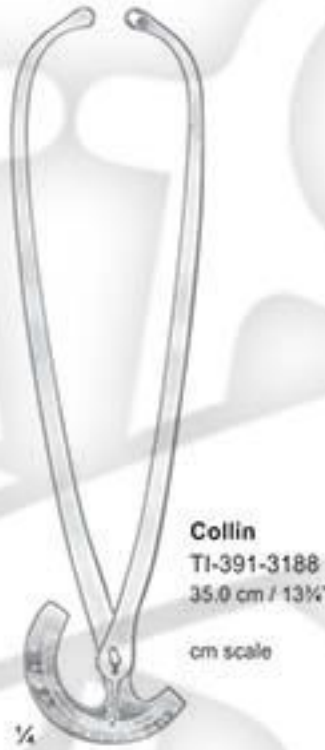

Collin
TI-391-3188
35.0 cm / 13 3/4"
cm scale



Breisky
TI-391-3189
33.0 cm / 13"
cm/inch scale



Naegele
TI-391-3190 - 36.0 cm / 14"
TI-391-3191 - 40.0 cm / 16"



Simpson
TI-391-3192
30.0 cm / 12"



Simpson-Braun
TI-391-3193
36.0 cm / 14"



Simpson-Luikart
TI-391-3194
36.0 cm / 14"



De Lee
TI-392-3195
36.0 cm / 12"

¼



De Lee
TI-392-3196-36.0 cm / 14"
TI-392-3197-39.0 cm / 15½"

¼



Elliot
TI-392-3198
32.0 cm / 12½"
TI-392-3199
38.0 cm / 15"

¼



Mc Lean
TI-392-3200
36.0 cm / 14"

¼



Kielland
TI-392-3201
41.0 cm / 16"

¼



Kielland-Luikart
TI-392-3202
40.0 cm / 15½"

¼



Piper
TI-392-3203
44.0 cm / 17½"

¼



Green-Armytage
TI-393-3204
21.0 cm / 8 1/4"



Sellheim
TI-393-3205
28.0 cm / 11"

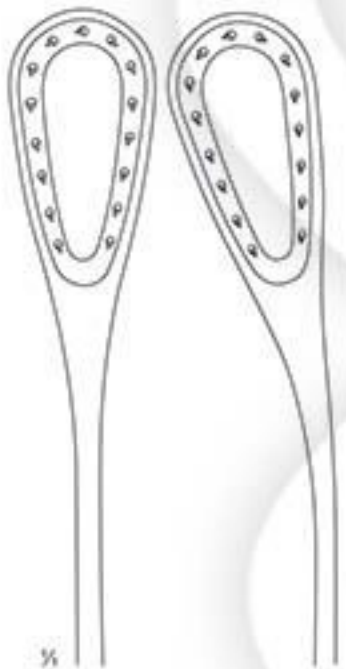

TI-393-3206



TI-393-3207



Winter
28.0 cm / 11"



TI-393-3208

straight



TI-393-3209

curved



TI-393-3210

straight



TI-393-3211

curved



Saenger
27.0 cm / 10 5/8"

16

NEURO-SURGERY INSTRUMENTS





McKenzie
TI-394-3212 - 15.0 cm / 6"
TI-394-3213 - 19 cm / 7½"



McKenzie
TI-394-3214 - 15.0 cm / 6"
TI-394-3215 - 19 cm / 7½"

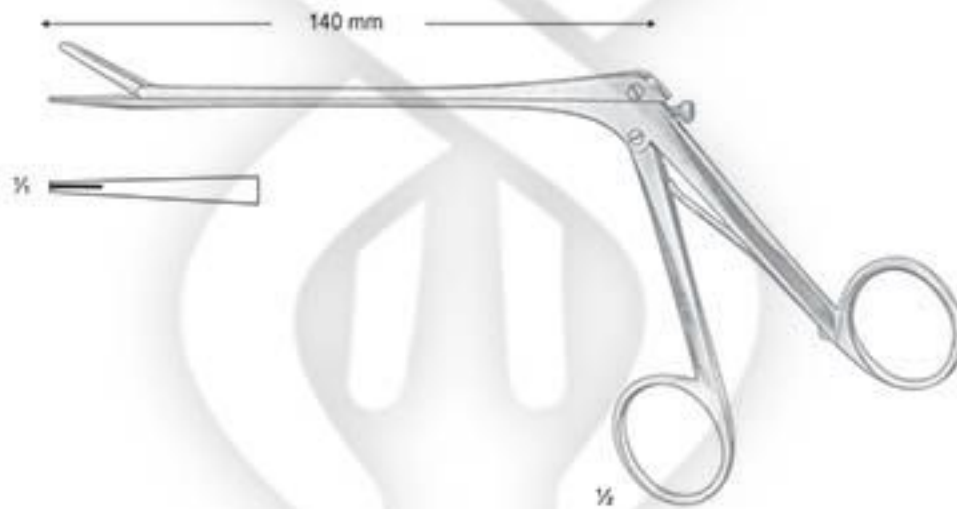

**Olivercrona-Toennis
(Scoville)**
TI-394-3216

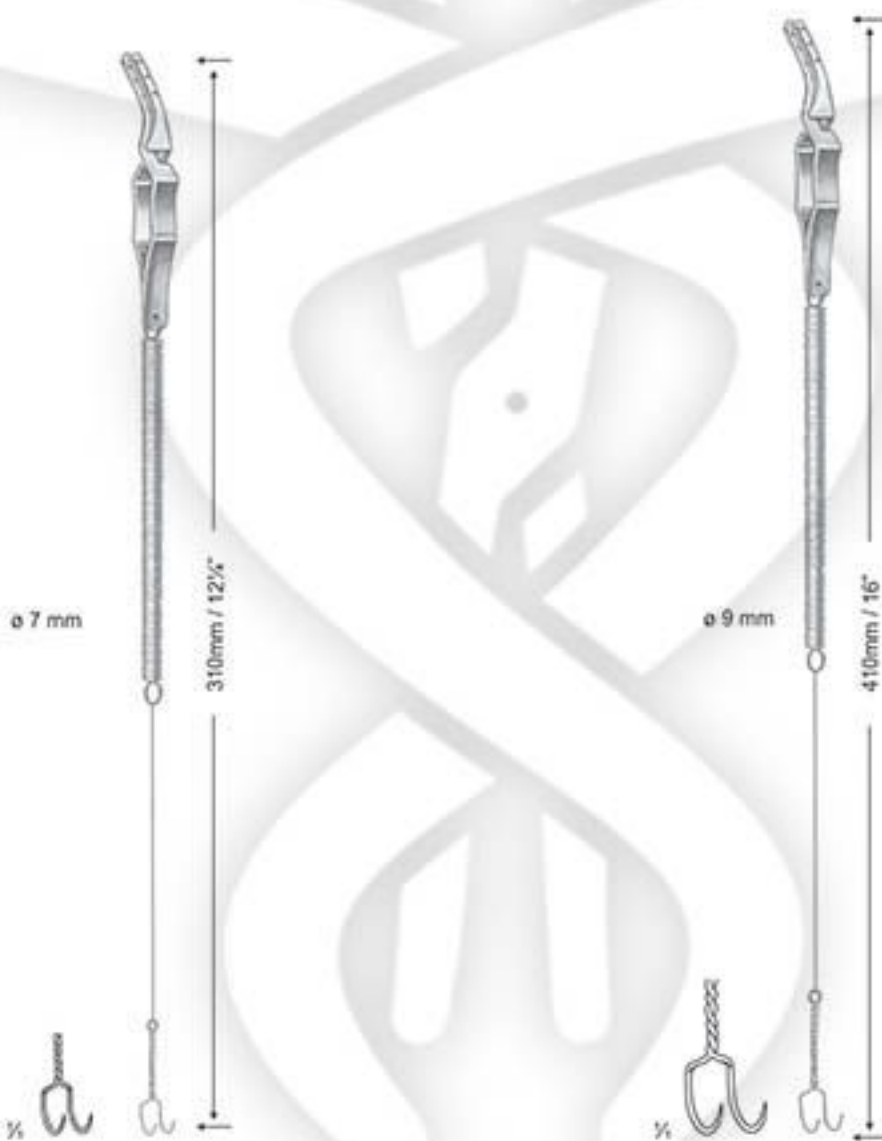

Yasargil
TI-395-3217
31.0 cm / 12 1/4"

Yasargil
TI-395-3218
41.0 cm / 16"



Penfield
TI-396-3219
17.5 cm / 7"
Fig. 1

Penfield
TI-396-3220
19.5 cm / 7 1/4"
Fig. 2

Penfield
TI-396-3221
19.5 cm / 7 1/4"
Fig. 3

Penfield
TI-396-3222
21.5 cm / 8 1/2"
Fig. 4

Penfield
TI-396-3223
29.0 cm / 11 1/2"
Fig. 5



Davis
TI-397-3224
24.5 cm / 9 1/2"



Frazier
TI-397-3225
15.0 cm / 6"



Hoer
TI-397-3226
15.0 cm / 6"



Hoer
TI-397-3227
15.0 cm / 6"

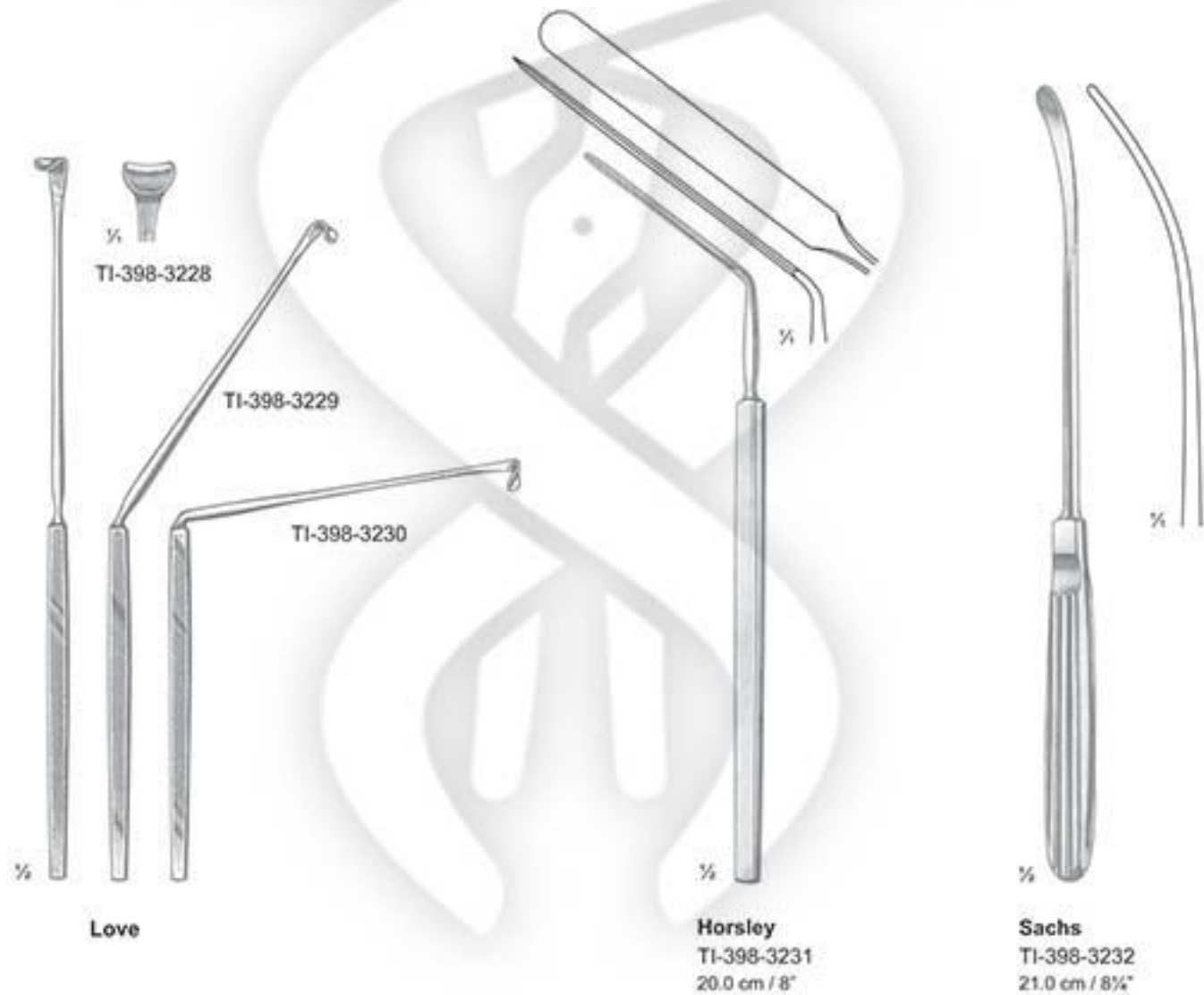



- TI-399-3233 - 8 mm
- TI-399-3234 - 11 mm
- TI-399-3235 - 14 mm
- TI-399-3236 - 17 mm
- TI-399-3237 - 20 mm

Heifetz
20.0 cm / 8"
malleable



Cushing

- TI-399-3238
17.0 cm / 6 1/2"
8 x 10 mm
- TI-399-3239
20.0 cm / 8"
13 x 15 mm
- TI-399-3240
28.0 cm / 11"
16 x 18 mm



Olivercrona
18.0 cm / 7"

width of spatulas

	upper end mm	lower end mm	
concave			convex
TI-399-3241	7	9	TI-399-3245
TI-399-3242	11	13	TI-399-3246
TI-399-3243	15	18	TI-399-3247
TI-399-3244	18	22	TI-399-3248



TI-400-3249
23.0 cm / 9"

Scoville



TI-400-3250
24.0 cm / 9½"

Holsher



TI-400-3251
20.0 cm / 8"

Scoville



TI-400-3252
21.0 cm / 8½"

Special Mode

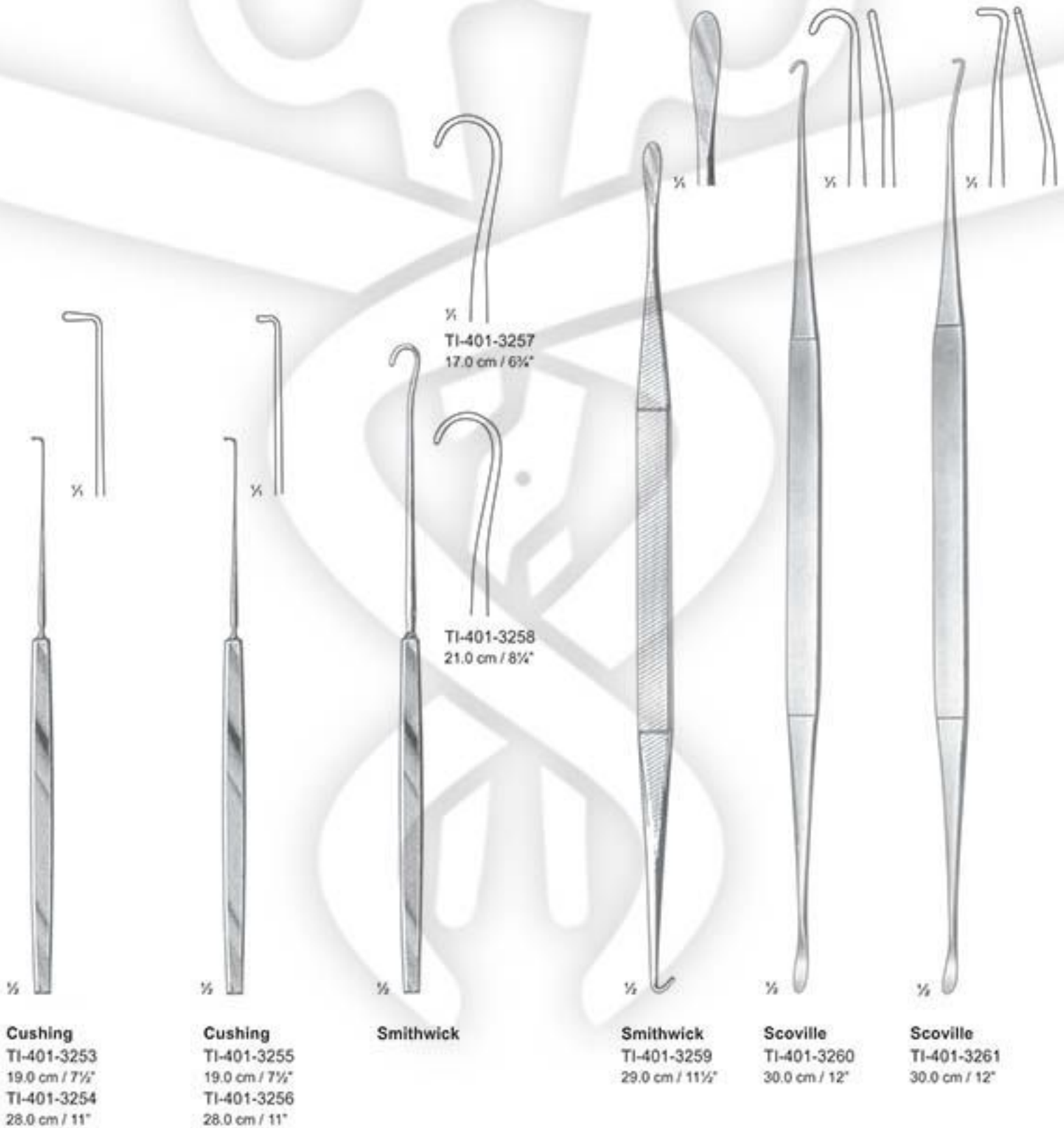

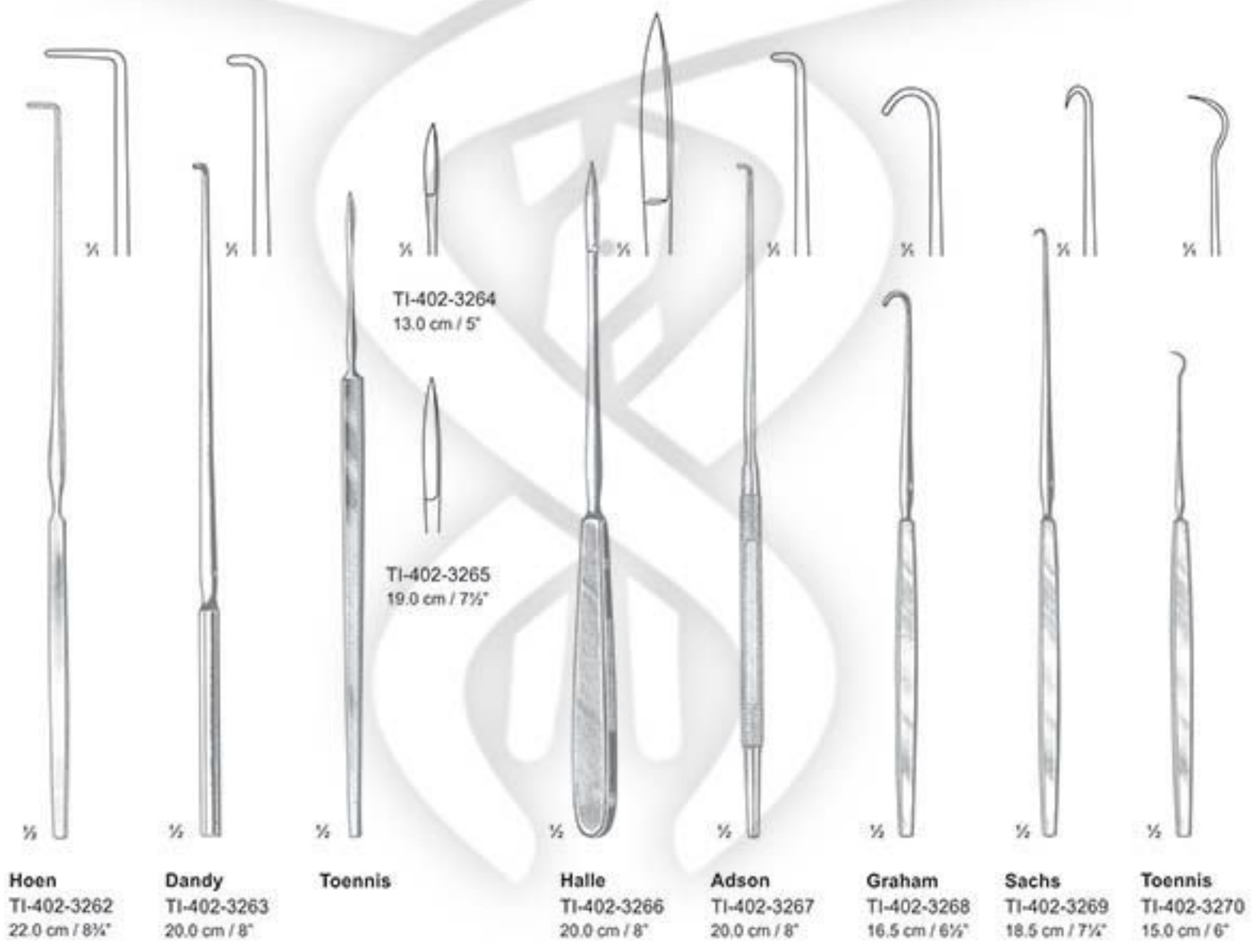

Hoan
TI-402-3262
22.0 cm / 8 3/4"

Dandy
TI-402-3263
20.0 cm / 8"

Toennis

TI-402-3264
13.0 cm / 5"

TI-402-3265
19.0 cm / 7 1/2"

Halle
TI-402-3266
20.0 cm / 8"

Adson
TI-402-3267
20.0 cm / 8"

Graham
TI-402-3268
16.5 cm / 6 1/2"

Sachs
TI-402-3269
18.5 cm / 7 1/4"

Toennis
TI-402-3270
15.0 cm / 6"

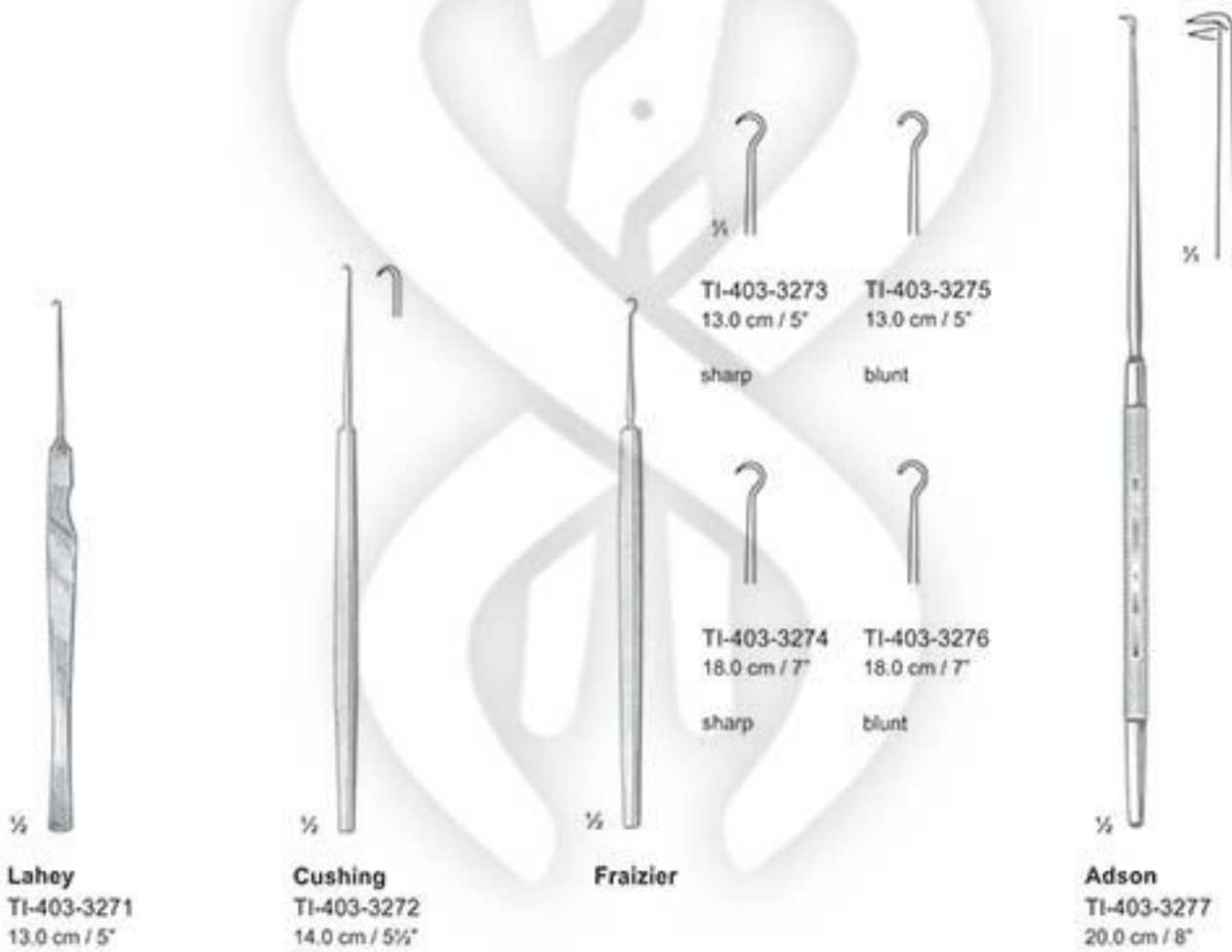

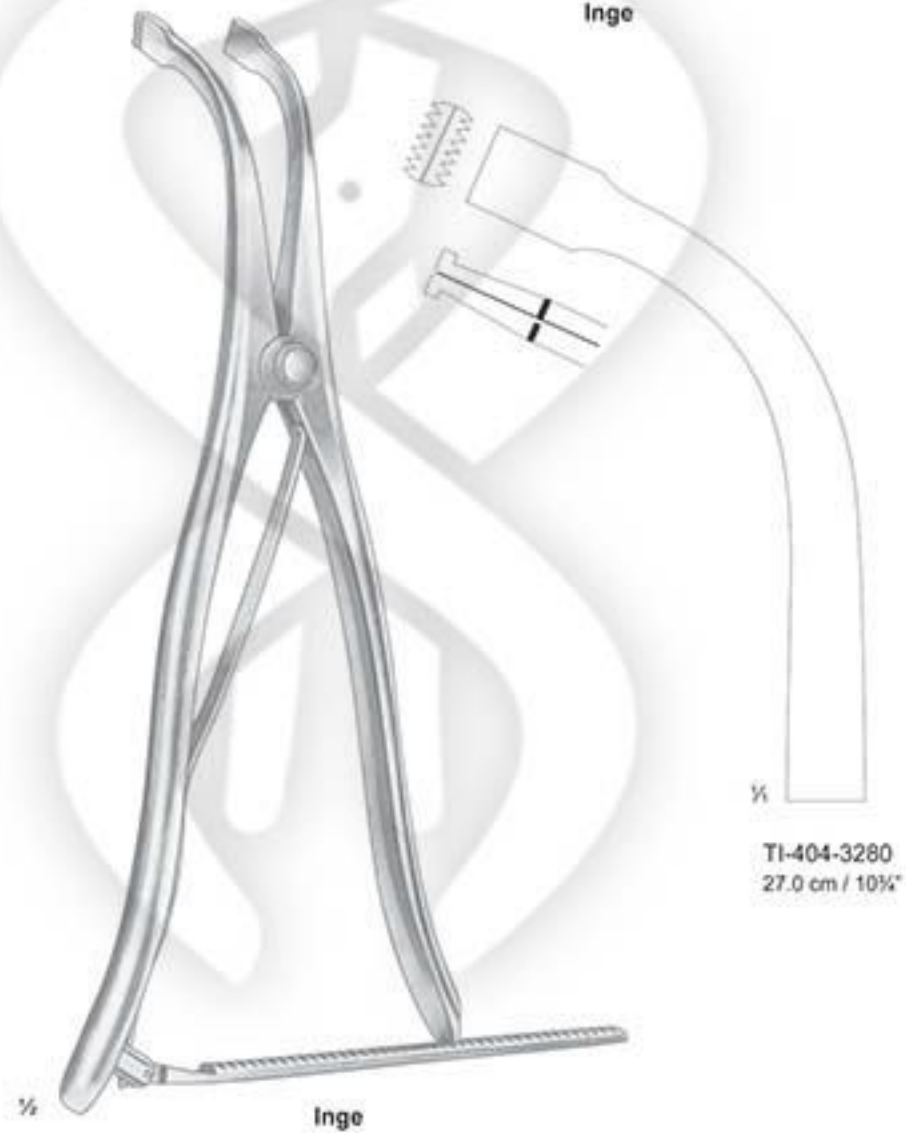

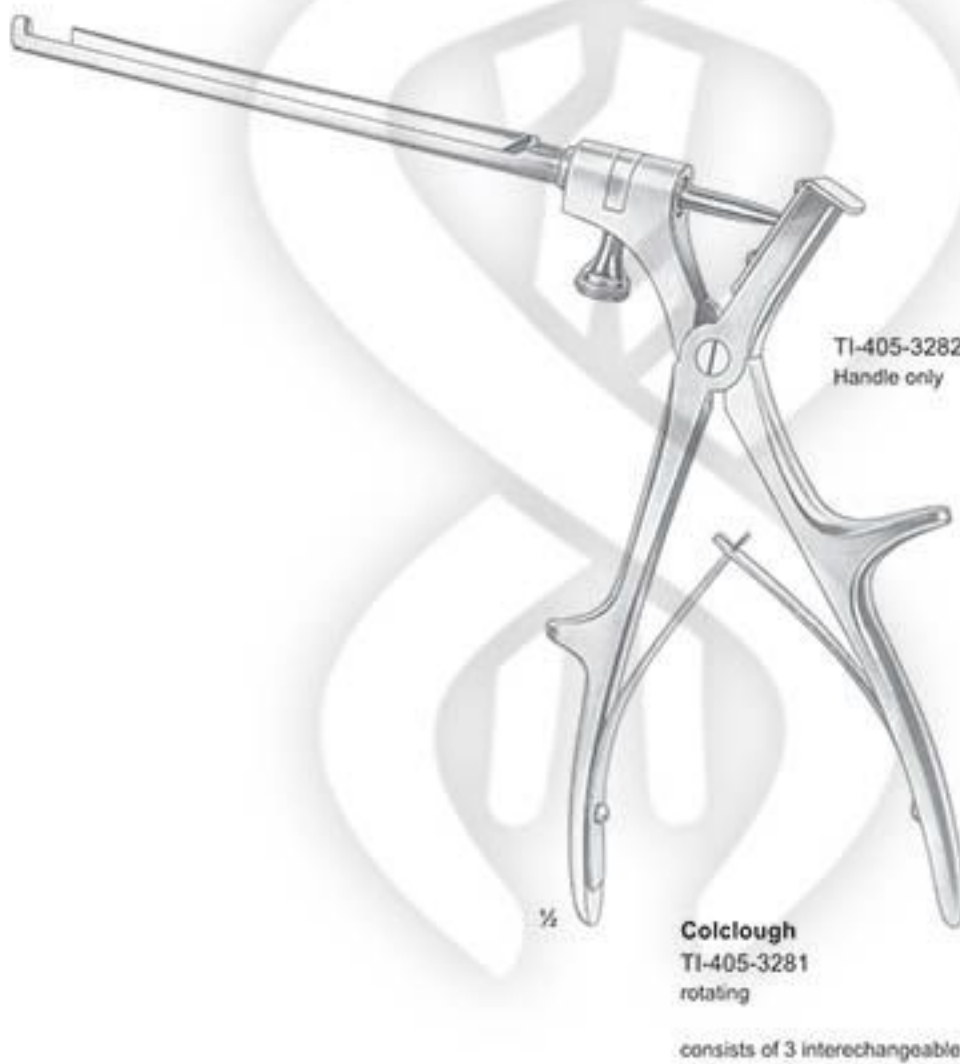



Length of shaft	150 mm 6"	150 mm 6"	200 mm 8"	200 mm 8"
Width of bite	3 mm	5 mm	3 mm	5 mm
Cat. Ref	TI-406-3286	TI-406-3287	TI-406-3288	TI-406-3289

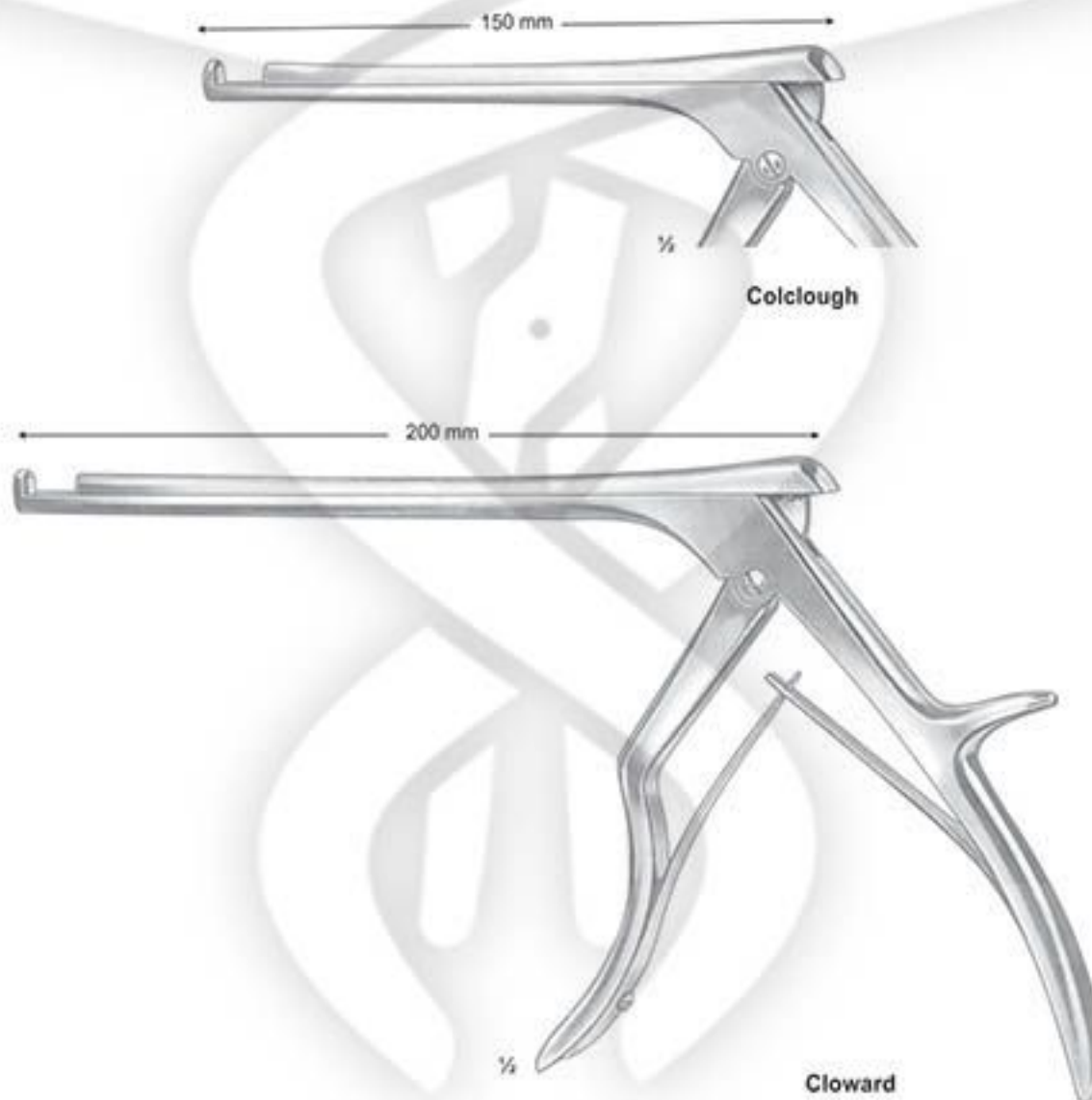



Length of shaft	150 mm 6"	150 mm 6"	200 mm 8"	200 mm 8"
Width of bite	3 mm	5 mm	3 mm	5 mm
Cat. Ref	TI-407-3290	TI-407-3291	TI-407-3292	TI-407-3293

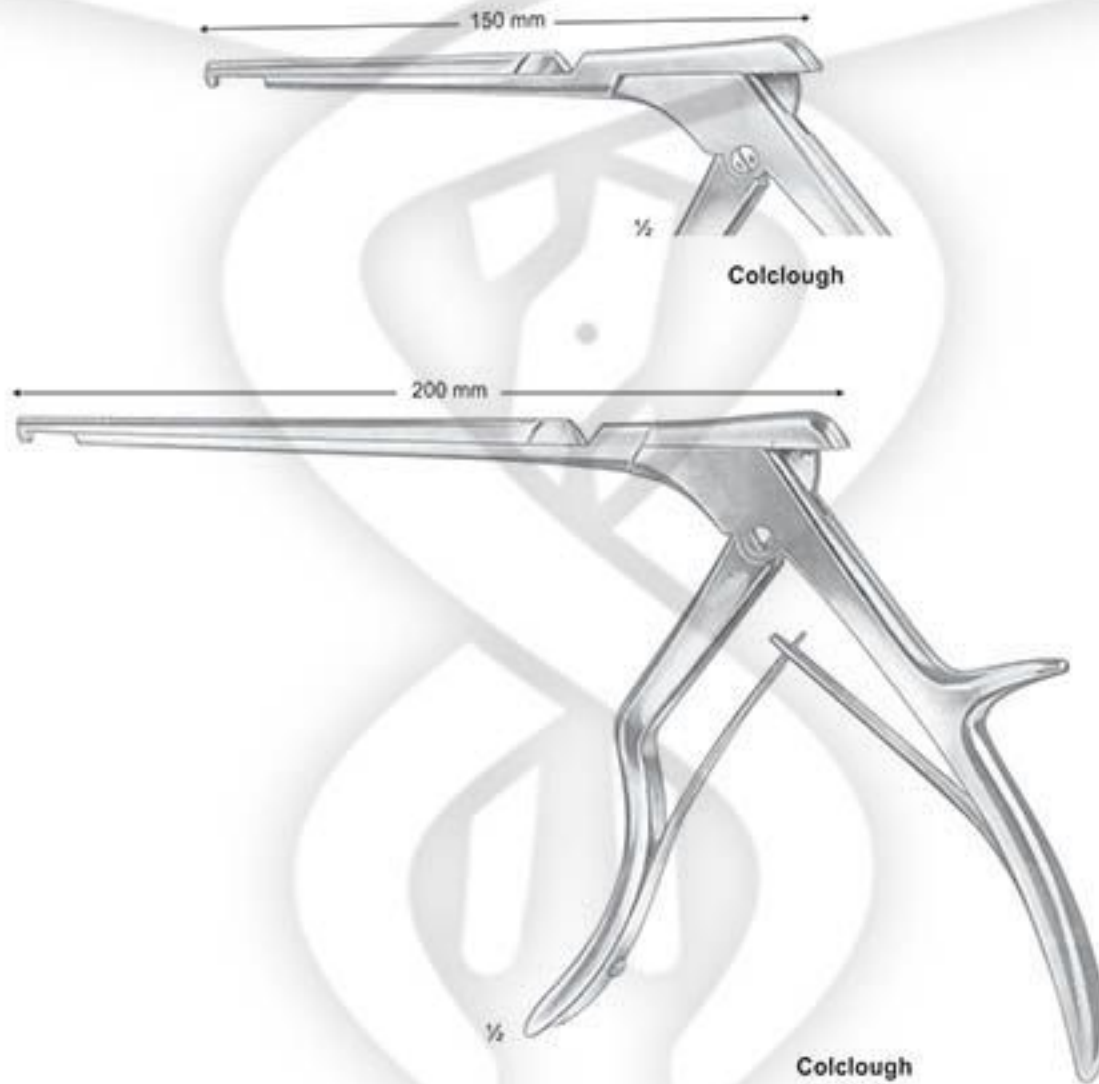



Length of shaft	150 mm 6"	150 mm 6"	200 mm 8"	200 mm 8"
Width of bite	3 mm	5 mm	3 mm	5 mm
Cat. Ref.	TI-408-3294	TI-408-3295	TI-408-3296	TI-408-3297

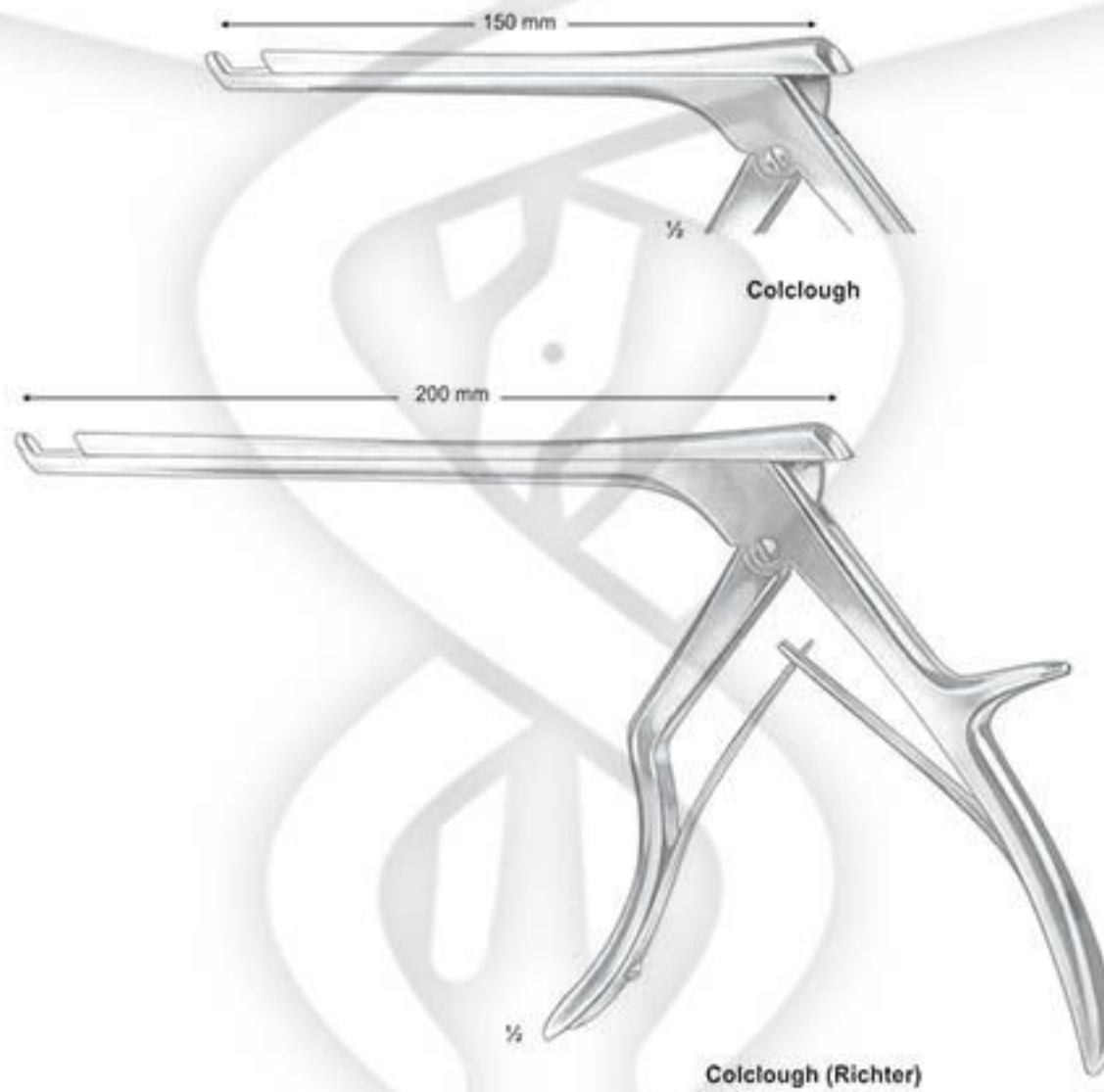

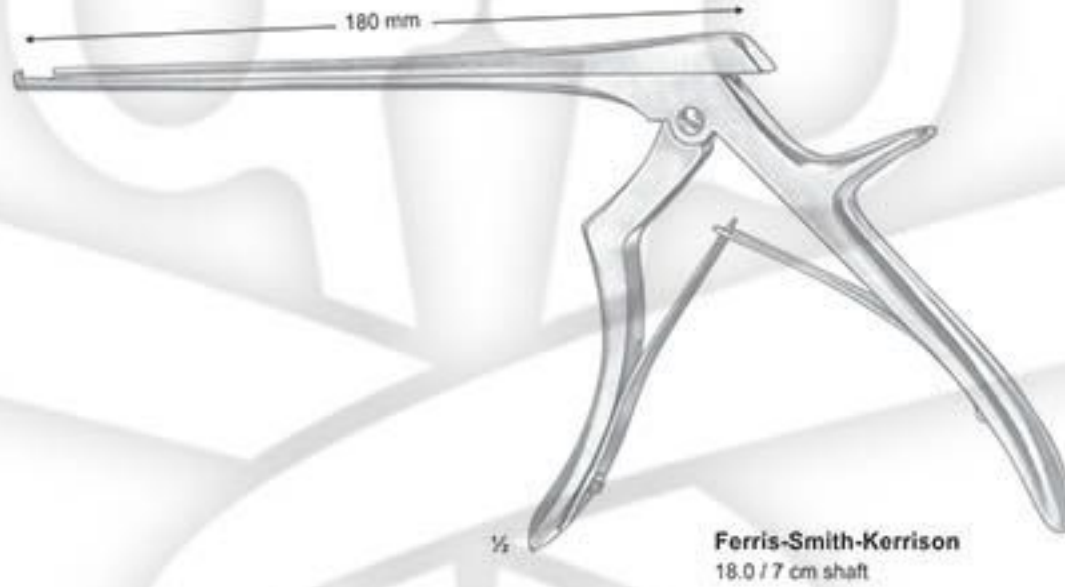

cutting upward

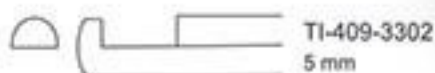
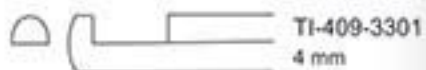

cutting downward

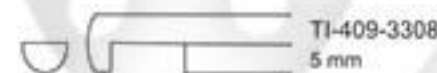
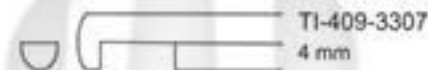

cutting 40° forward

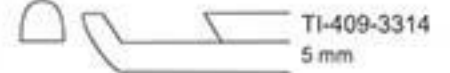
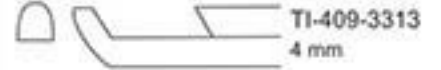
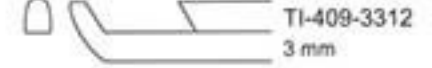

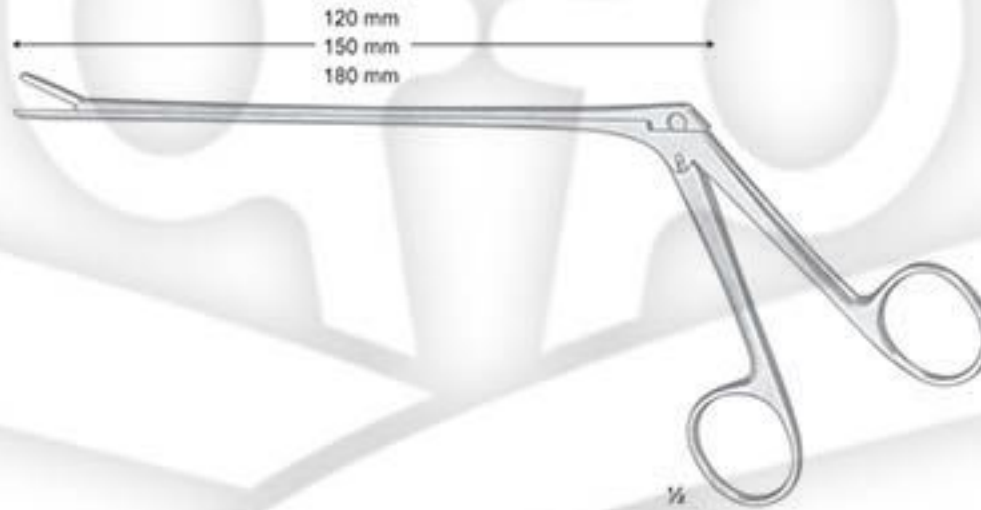

Cushing
2 mm



2 x 10 mm
TI-410-3316 - 12.0 cm
TI-410-3317 - 15.0 cm
TI-410-3318 - 18.0 cm



2 x 10 mm / 45°
TI-410-3319 - 12.0 cm
TI-410-3320 - 15.0 cm
TI-410-3321 - 18.0 cm

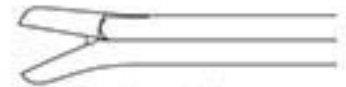

2 x 10 mm / 45°
TI-410-3322 - 12.0 cm
TI-410-3323 - 15.0 cm
TI-410-3324 - 18.0 cm

Love-Gruenwald
3 mm

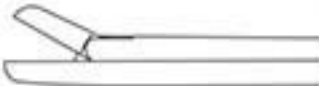

3 x 10 mm
TI-410-3325 - 12.0 cm
TI-410-3326 - 15.0 cm
TI-410-3327 - 18.0 cm



3 x 10 mm / 45°
TI-410-3328 - 12.0 cm
TI-410-3329 - 15.0 cm
TI-410-3330 - 18.0 cm

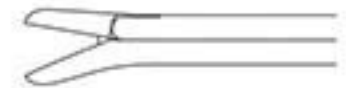

3 x 10 mm / 45°
TI-410-3331 - 12.0 cm
TI-410-3332 - 15.0 cm
TI-410-3333 - 18.0 cm

Spurling
4 mm



4 x 10 mm
TI-410-3334 - 12.0 cm
TI-410-3335 - 15.0 cm
TI-410-3336 - 18.0 cm



4 x 10 mm / 45°
TI-410-3337 - 12.0 cm
TI-410-3338 - 15.0 cm
TI-410-3339 - 18.0 cm



4 x 10 mm / 45°
TI-410-3340 - 12.0 cm
TI-410-3341 - 15.0 cm
TI-410-3342 - 18.0 cm

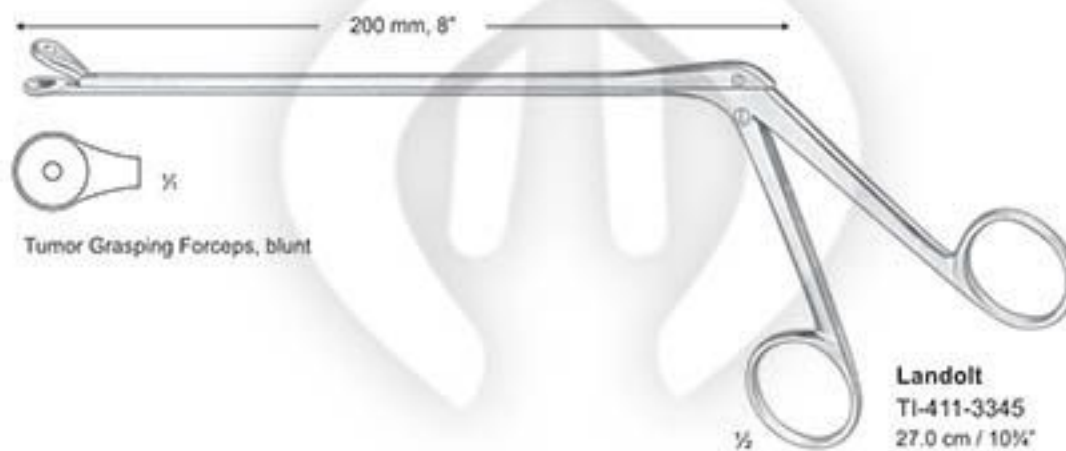
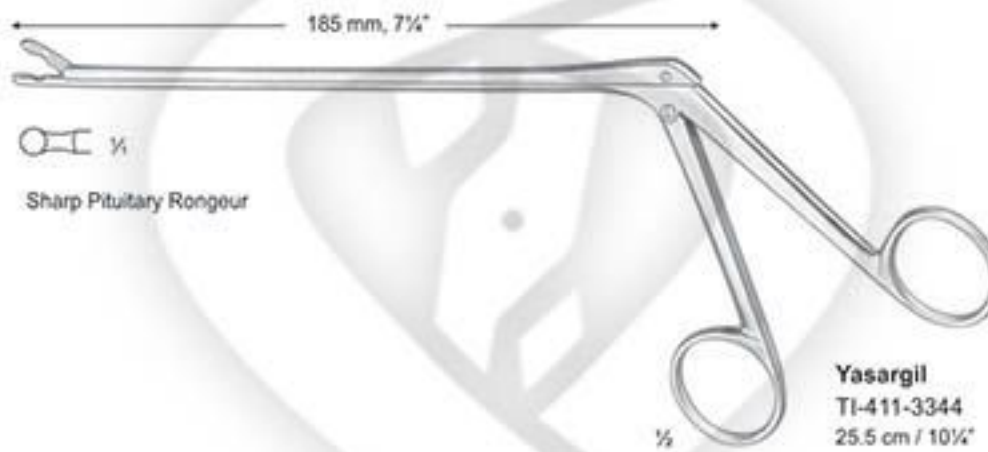
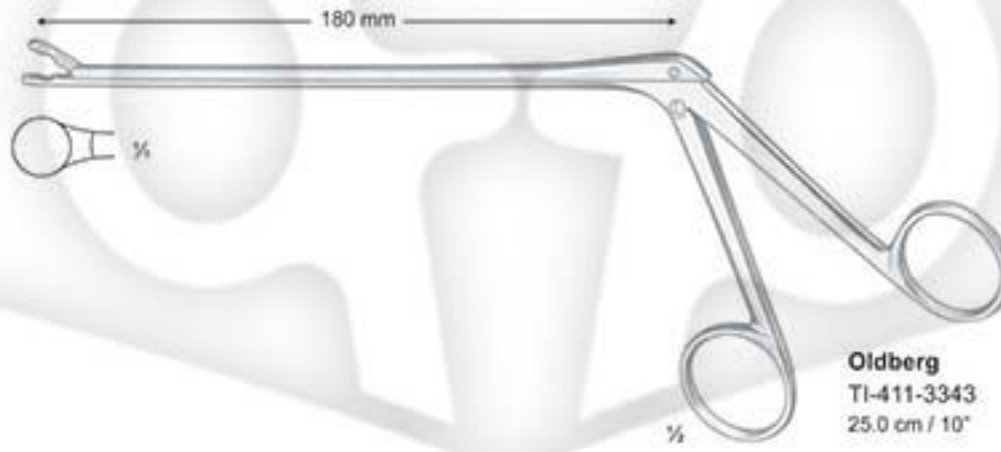

Kerrison Rongeurs

18.0 cm / 7" shaft

90° Up-bite	90° Down-bite	
TI-412-3346	TI-412-3351	2mm bite
TI-412-3347	TI-412-3352	3mm bite
TI-412-3348	TI-412-3353	4mm bite
TI-412-3349	TI-412-3354	5mm bite
TI-412-3350	TI-412-3355	6mm bite



Kerrison Rongeurs

20.0 cm / 8" shaft

90° Up-bite	90° Down-bite	
TI-412-3356	TI-412-3361	2mm bite
TI-412-3357	TI-412-3362	3mm bite
TI-412-3358	TI-412-3363	4mm bite
TI-412-3359	TI-412-3364	5mm bite
TI-412-3360	TI-412-3365	6mm bite

Kerrison Rongeurs

18.0 cm / 7" shaft, 40° forward-angle

TI-412-3366	2mm bite	TI-412-3369	5mm bite
TI-412-3367	3mm bite	TI-412-3370	6mm bite
TI-412-3368	4mm bite		

Kerrison Rongeurs

20.0 cm / 8" shaft, 40° forward-angle

TI-412-3371	2mm bite	TI-412-3374	5mm bite
TI-412-3372	3mm bite	TI-412-3375	6mm bite
TI-412-3373	4mm bite		



Kerrison Rongeurs

23.0 cm / 9" shaft, 40° forward-angle

TI-412-3376	2mm bite	TI-412-3379	5mm bite
TI-412-3377	3mm bite	TI-412-3380	6mm bite
TI-412-3378	4mm bite		

Kerrison Rongeurs

25.0 cm / 10" shaft, 40° forward-angle

TI-412-3381	2mm bite	TI-412-3384	5mm bite
TI-412-3382	3mm bite	TI-412-3385	6mm bite
TI-412-3383	4mm bite		

Kerrison Rongeurs

28.0 cm / 11" shaft, 40° forward-angle

TI-412-3386	2mm bite	TI-412-3389	5mm bite
TI-412-3387	3mm bite	TI-412-3390	6mm bite
TI-412-3388	4mm bite		

Love-Kerrison Rongeurs

40° forward-angle

18.0 cm / 7" shaft	20.0 cm / 8" shaft	
TI-413-3391	TI-413-3396	2mm bite
TI-413-3392	TI-413-3397	3mm bite
TI-413-3393	TI-413-3398	4mm bite
TI-413-3394	TI-413-3399	5mm bite
TI-413-3395	TI-413-3400	6mm bite

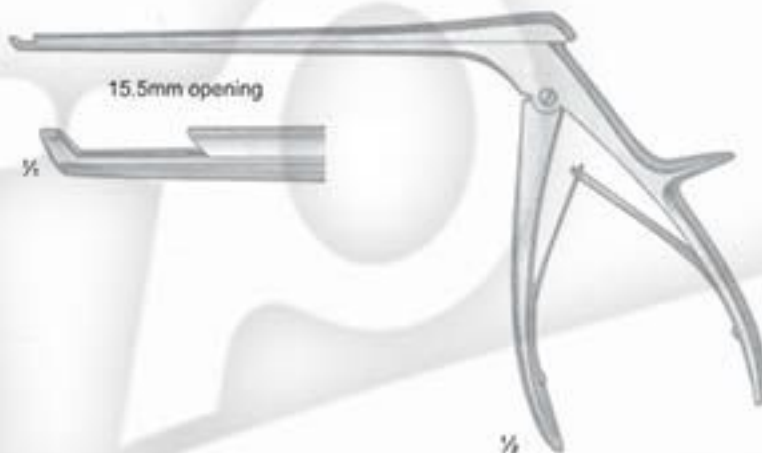

Love-Kerrison Rongeurs

improved handle, 90° up-bite

18.0 cm / 7" shaft	20.0 cm / 8" shaft	
TI-413-3401	TI-413-3406	2mm bite
TI-413-3402	TI-413-3407	3mm bite
TI-413-3403	TI-413-3408	4mm bite
TI-413-3404	TI-413-3409	5mm bite
TI-413-3405	TI-413-3410	6mm biteZ



Love-Kerrison Rongeurs

improved handle, 40° forward-angle

18.0 cm / 7" shaft	20.0 cm / 8" shaft	23.0 cm / 9" shaft	28.0 cm / 11" shaft	
TI-413-3411	TI-413-3416	TI-413-3421	TI-413-3426	2mm bite
TI-413-3412	TI-413-3417	TI-413-3422	TI-413-3427	3mm bite
TI-413-3413	TI-413-3418	TI-413-3423	TI-413-3428	4mm bite
TI-413-3414	TI-413-3419	TI-413-3424	TI-413-3429	5mm bite
TI-413-3415	TI-413-3420	TI-413-3425	TI-413-3430	6mm bite

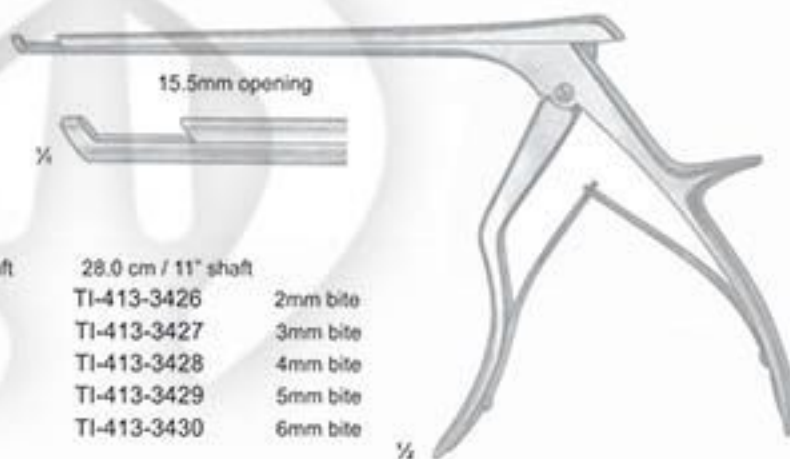

Love-Kerrison Rongeur

Improved handle, 20.0 cm / 8" shaft,
90° down-bite

- TI-414-3431 2mm bite
- TI-414-3432 3mm bite
- TI-414-3433 4mm bite
- TI-414-3434 5mm bite
- TI-414-3435 6mm bite



Laminectomy Rongeur

40° forward-angle

- | | | |
|------------------------|--------------------|----------|
| 17.5 cm / 6 7/8" shaft | 20.0 cm / 8" shaft | |
| TI-414-3436 | TI-414-3438 | 3mm bite |
| TI-414-3437 | TI-414-3439 | 5mm bite |

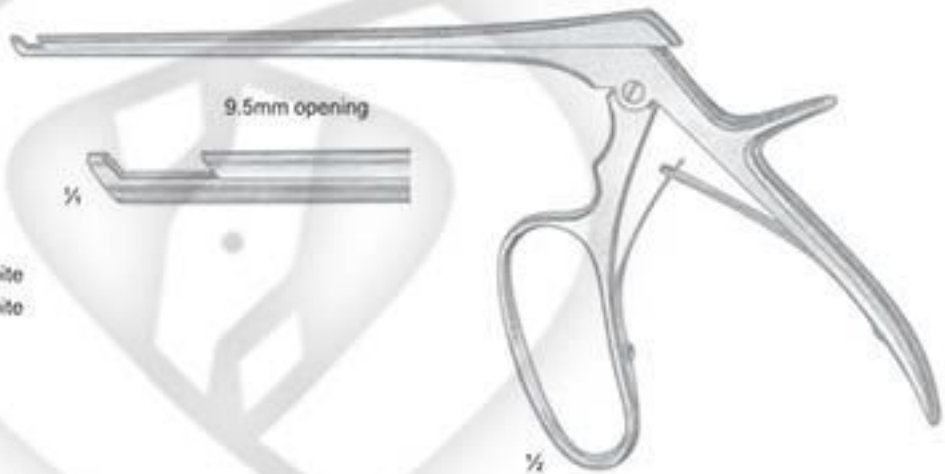

Sella Punches

18.0 cm / 7" shaft, 2mm bite

- TI-414-3440 90° down-bite
- TI-414-3441 40° down-bite
- TI-414-3442 90° down-bite
- TI-414-3443 40° down-bite

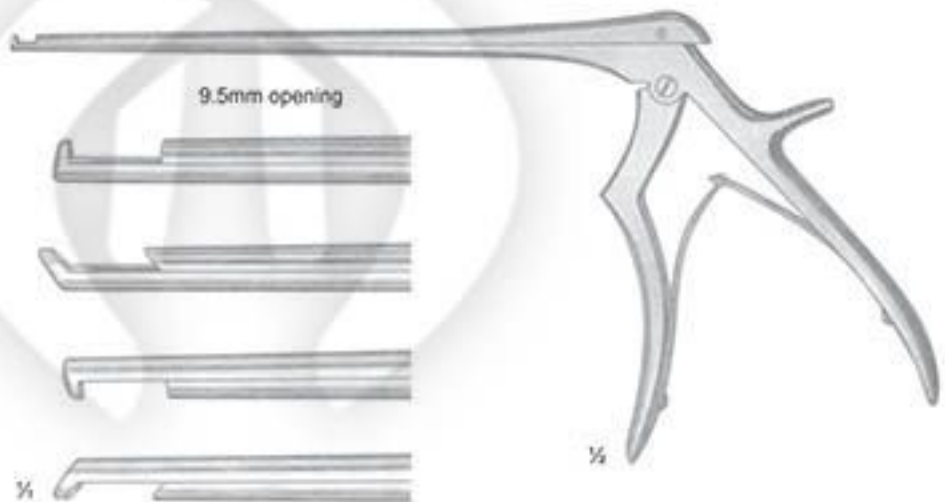

Schlesinger Rongeurs

13.0 cm / 5" shaft, serrated jaws, straight

- TI-415-3444 2 x 10mm bite
- TI-415-3445 3 x 10mm bite
- TI-415-3446 4 x 10mm bite
- TI-415-3447 3 x 10mm bite, up angled

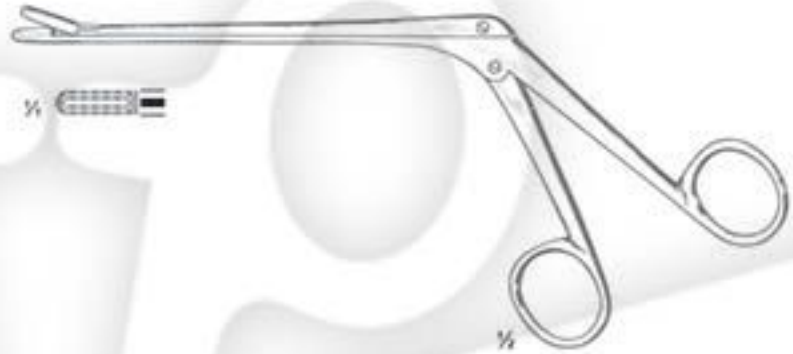

Special Model

13.0 cm / 5" shaft, serrated jaws,
6 x 10mm bite

- TI-415-3448 Straight
- TI-415-3449 Up-angled
- TI-415-3450 Down-angled



Wilde Rongeurs

fenestrated jaws straight

- | | | | |
|------------------------|--------------------|--------------------|----------|
| 14.0 cm / 5 1/2" shaft | 18.0 cm / 7" shaft | 23.0 cm / 9" shaft | |
| TI-415-3451 | TI-415-3454 | TI-415-3457 | 4mm bite |
| TI-415-3452 | TI-415-3455 | TI-415-3458 | 5mm bite |
| TI-415-3453 | TI-415-3456 | TI-415-3459 | 6mm bite |



Wilde Rongeurs

TI-415-3460
fenestrated jaws, up-angled
10.8 cm / 4 1/4" shaft, 5mm bite



Jackson Rongeurs

18.0 cm / 7" shaft, fenestrated jaws

TI-416-3461 4 x 8mm bite, 70° up-angled



Peapod (Bead-Type) Forceps

14.0 cm / 5 1/2" shaft, 45° up-angled

TI-416-3462 2.3 x 7mm bite

TI-416-3463 2.7 x 7mm bite

TI-416-3464 3.2 x 7mm bite

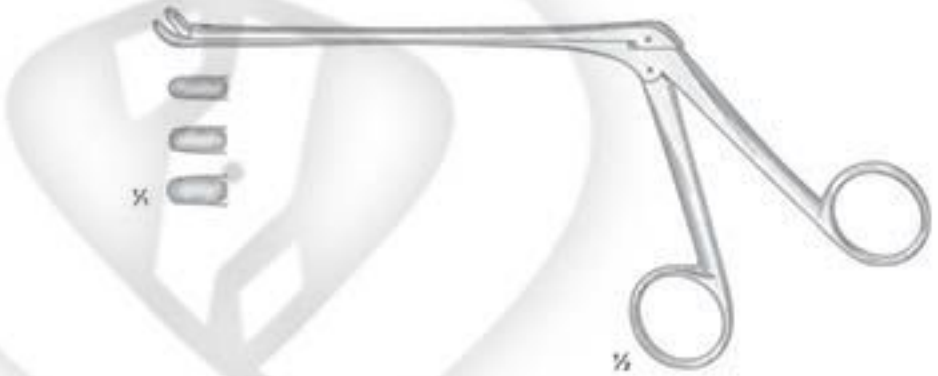

Takahashi Rongeur

TI-416-3465

13.0 cm / 5" shaft, 4 x 10mm bite



Ferris-Smith Cup Jaw Rongeurs

18.0 cm / 7" shaft, Straight

- TI-417-3466 2 x 10mm bite
- TI-417-3467 3 x 10mm bite
- TI-417-3468 4 x 10mm bite
- TI-417-3469 4 x 8mm bite
- TI-417-3470 6 x 10mm bite
- TI-417-3471 6 x 12mm bite

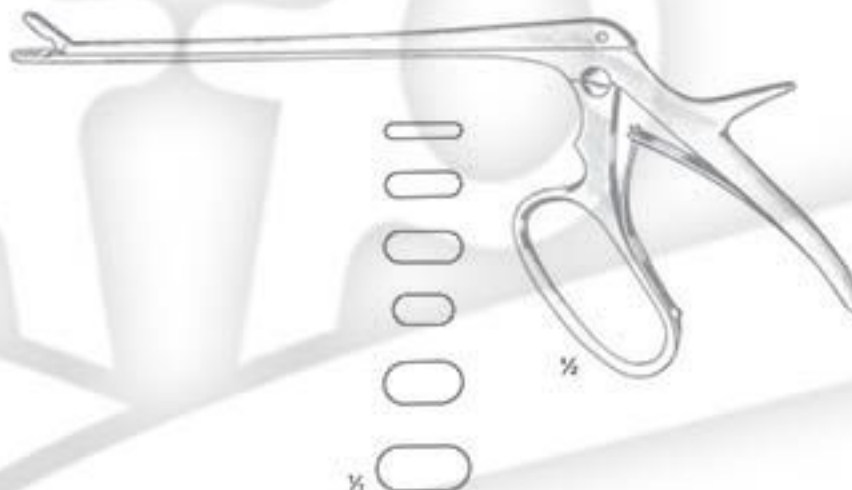

Ferris-Smith Cup Jaw Rongeurs

18.0 cm / 7" shaft, up-angled

- TI-417-3472 2 x 10mm bite
- TI-417-3473 3 x 10mm bite
- TI-417-3474 4 x 10mm bite
- TI-417-3475 6 x 10mm bite



Ferris-Smith Cup Jaw Rongeurs

18.0 cm / 7" shaft, down-angled

- TI-417-3476 2 x 10mm bite
- TI-417-3477 3 x 10mm bite
- TI-417-3478 4 x 10mm bite
- TI-417-3479 6 x 10mm bite



Stookey Cranial Rongeur

TI-417-3480

19.0 cm / 7 1/2" 3mm bite



Brain Leyla Retractor Double
TI-418-3481



Brain Leyla Retractor Single
TI-418-3482

17

OTOLOGY INSTRUMENTS

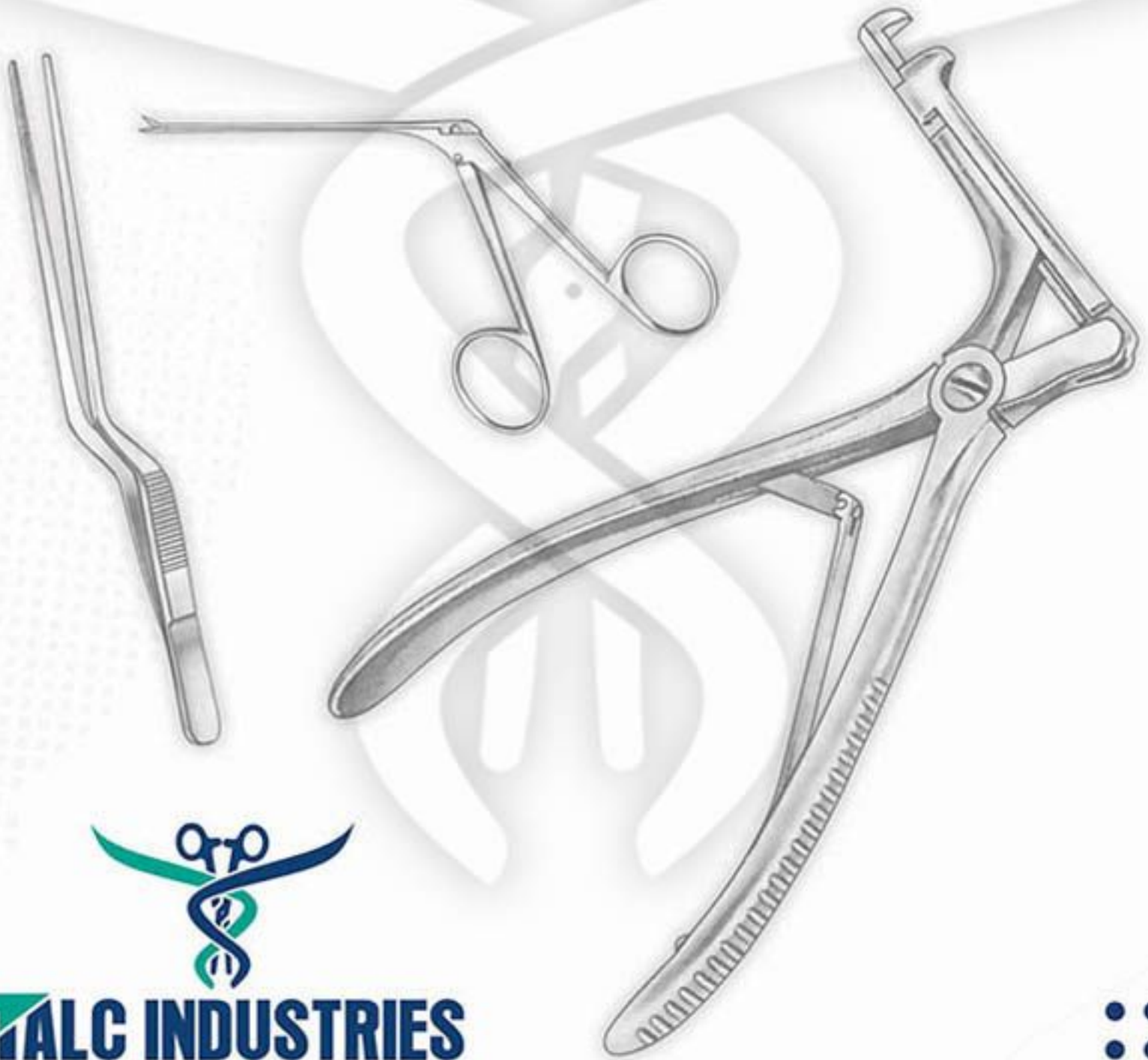

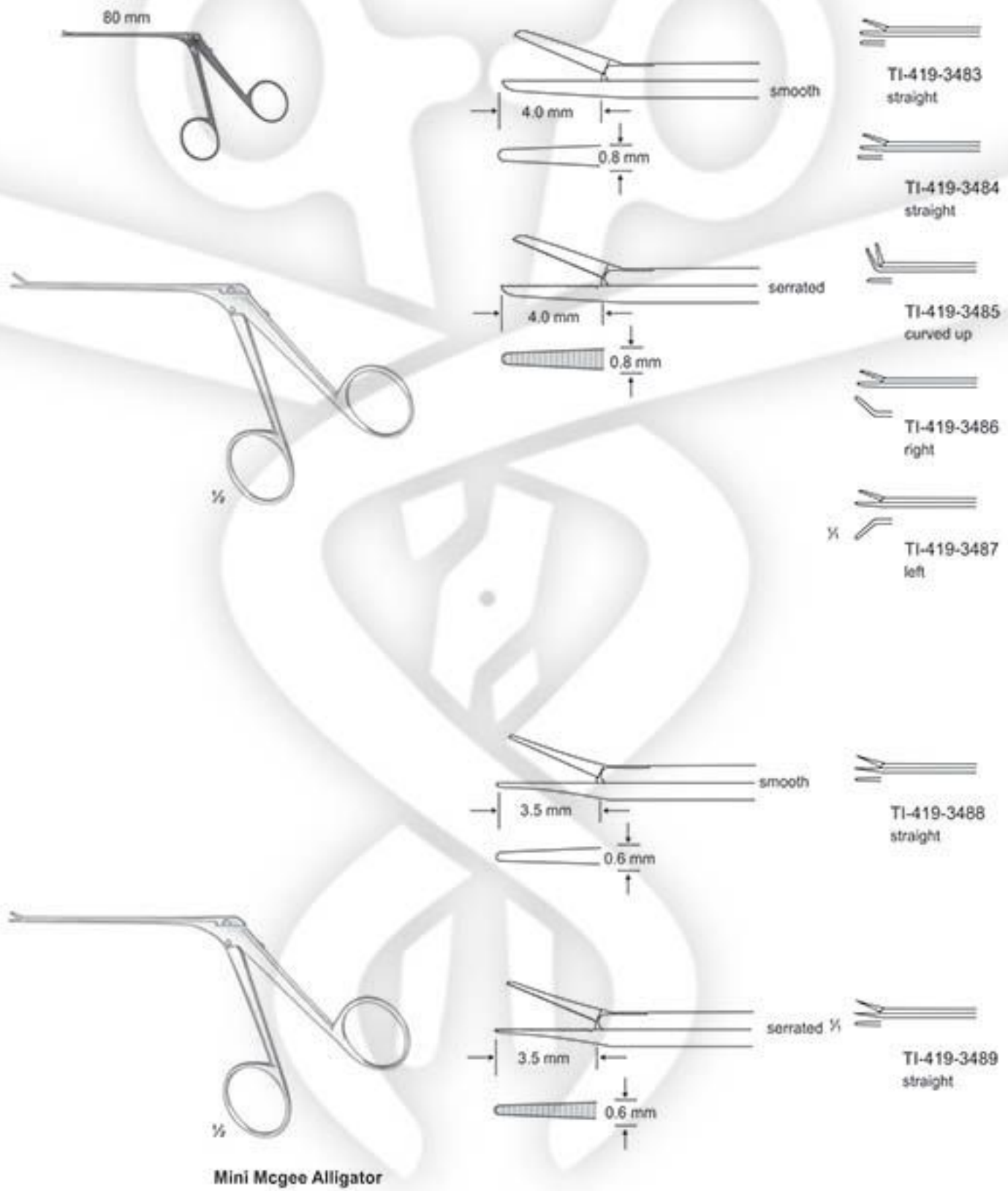

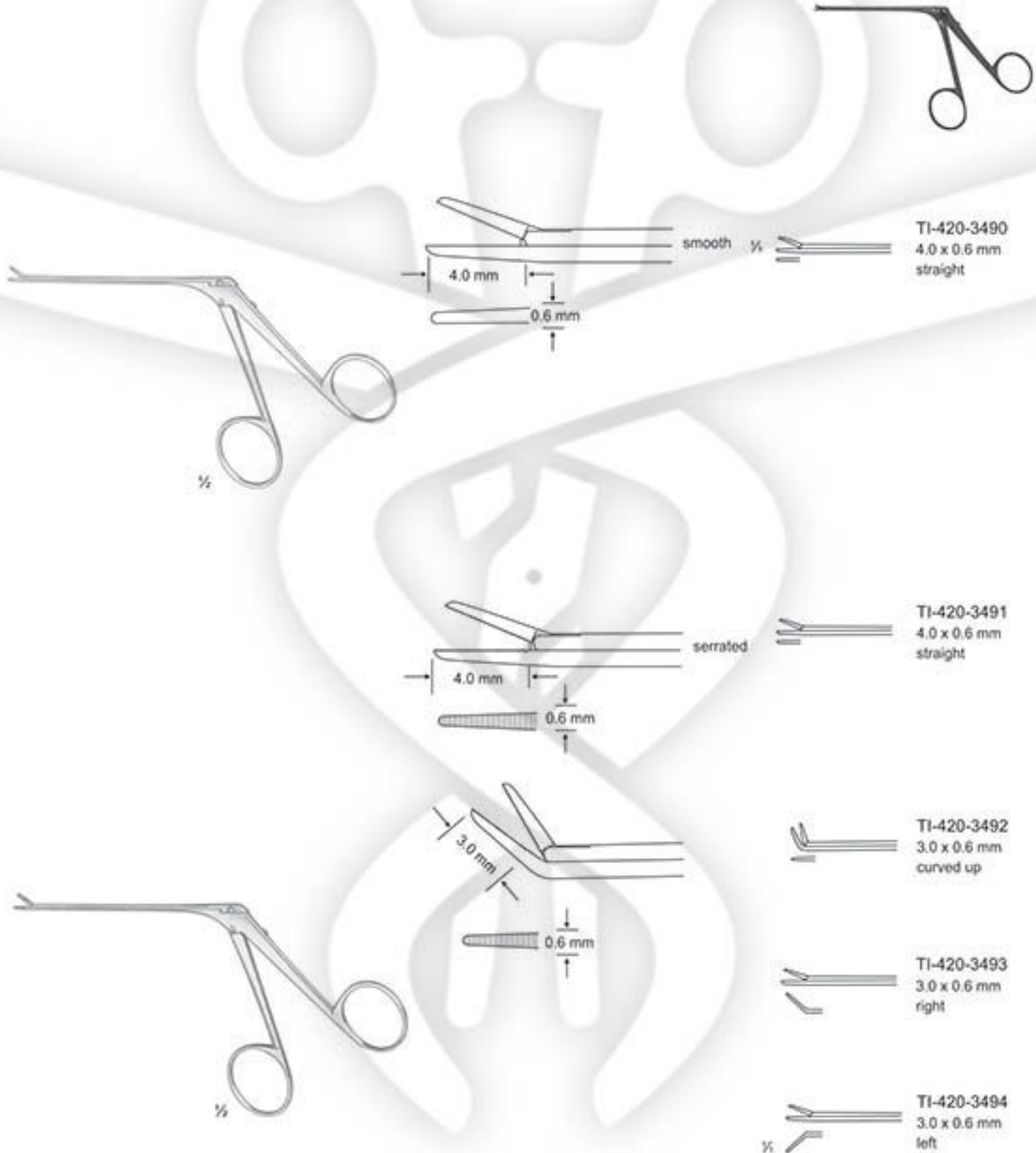

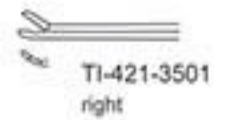
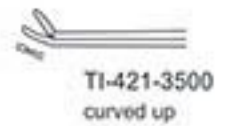
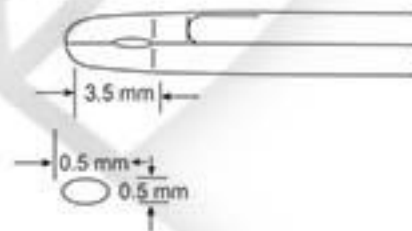
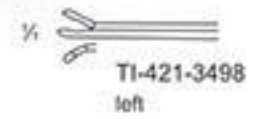
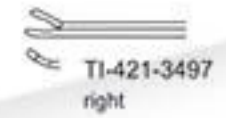
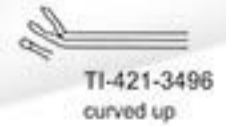
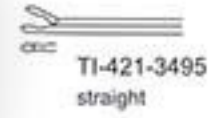
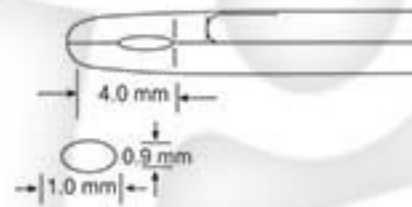

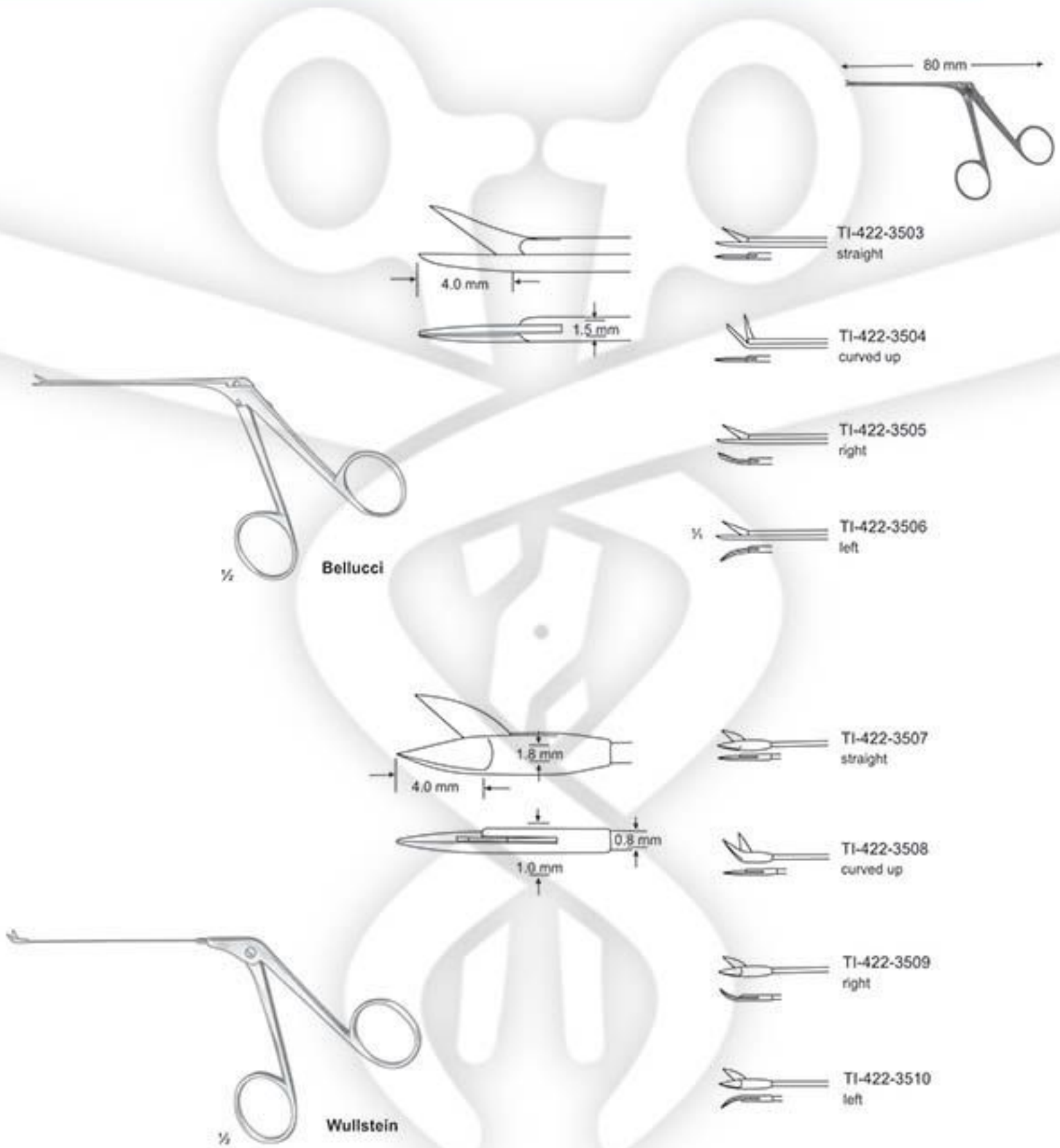



Greven
TI-423-3511

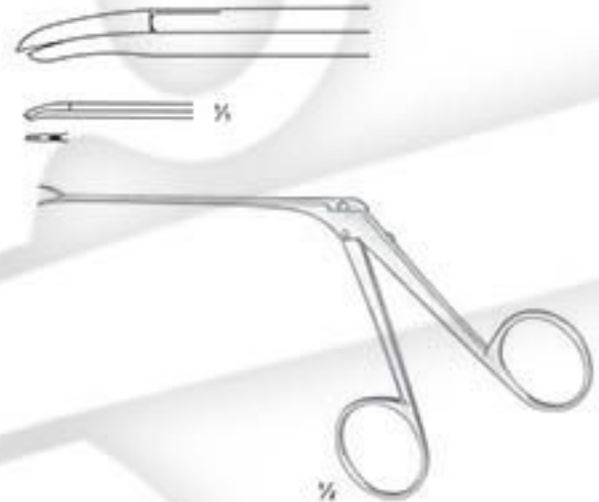

Schuknecht
TI-423-3512

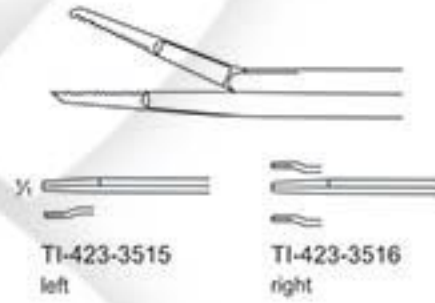
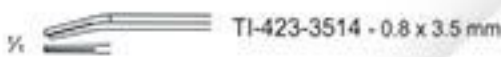
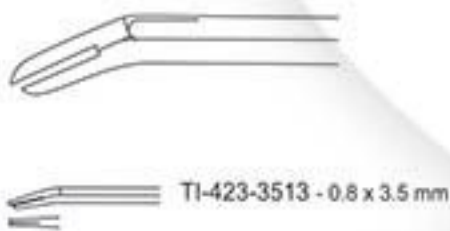

Mcgee



Juers



TI-424-3517



TI-424-3519 left



TI-424-3518



TI-424-3520 right



House-Dieter



House-Dieter



Fuller
TI-424-3521



Instrument for introducing teflon pistons



Schuknecht
TI-425-3522

Roller Knife

Schuknecht
TI-425-3523

Roller Knife

Schuknecht
TI-425-3524

Sickle Knife

Wullstein
TI-425-3525

Sickle Knife

Tabb
TI-425-3526

Sickle Knife

Plester
TI-425-3527

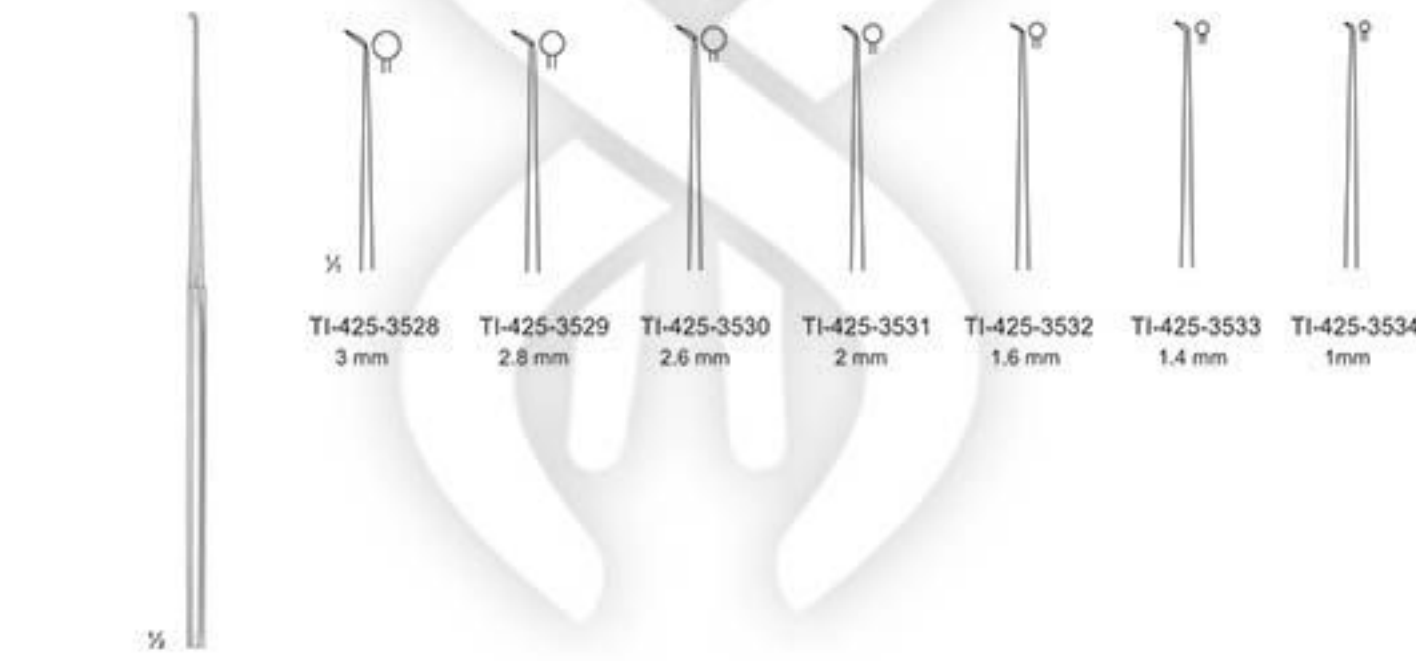

Rosen (Round Knives)

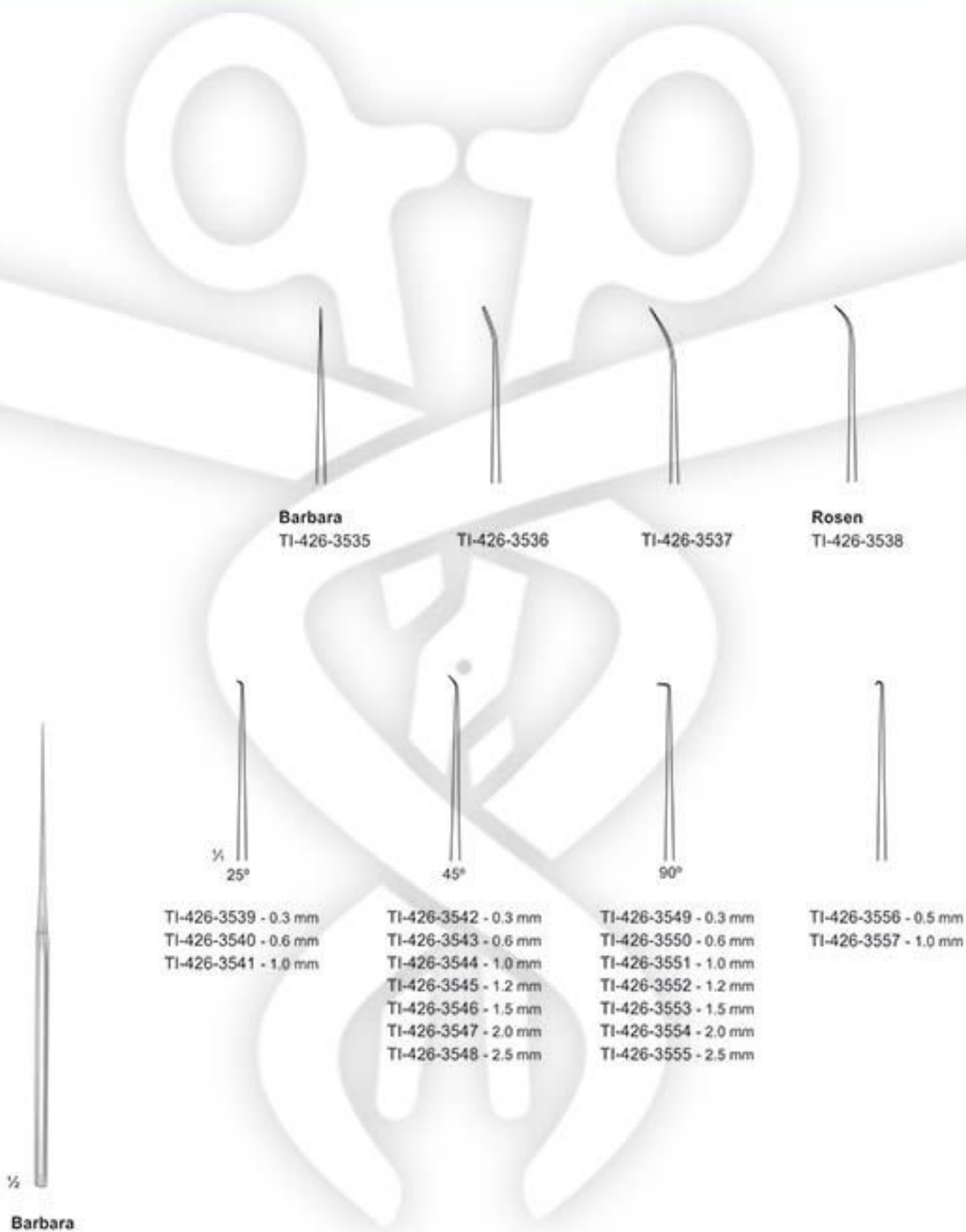



Hartmann
for children

Pieces Fig.
Set of 3 0-2 TI-427-3561



Hartmann
for adults

Pieces Fig.
Set of 3 2-4 TI-427-3566
Set of 4 1-4 TI-427-3567



Toynbee
for adults

Pieces Fig.
Set of 3 2-4 TI-427-3572
Set of 4 1-4 TI-427-3573



Gruber
for adults

Pieces Fig.
Set of 3 2-4 TI-427-3578



Gruber
for adults

Pieces Fig.
Set of 4 1-4 TI-427-3583



Zollner
for adults

Pieces Fig.
Set of 6 TI-427-3590

Aluminium black TI-427-3589 = 10.5 x 11.5 mm



Alloy
TI-428-3591
c° 128



Alloy
TI-428-3592
c° 256



Alloy
TI-428-3593
c° 512



Alloy
TI-428-3594
c° 1024



Alloy
TI-428-3595
c° 2048



Hartmann
TI-428-3596
c° 128



Hartmann
TI-428-3597
c° 256



Hartmann
TI-428-3598
c° 512



Hartmann
TI-428-3599
c° 1024



Hartmann
TI-428-3600
c° 2048



Hartmann
TI-428-3601
c° 4096



Krause
TI-429-3602

Krause-Voss
TI-429-3603



Troeltsch (Wilde)
TI-429-3604
11.0 cm / 4 1/2"

Troeltsch (Wilde)
TI-429-3605
12.0 cm / 4 3/4"

Troeltsch (Wilde)
TI-429-3606
13.0 cm / 5"

Lucae
TI-429-3607
14.0 cm / 5 1/2"

Jansen
TI-429-3608 - 16.0 cm / 6 1/4"
TI-429-3609 - 20.0 cm / 8"



Littauer
TI-430-3610
12.0 cm / 4 3/4"



Hartmann
TI-430-3611
12.0 cm / 4 3/4"
fine pattern



Hartmann
TI-430-3612
14.0 cm / 5 1/2"
standard pattern



Buck
TI-430-3613



Quire
TI-430-3614

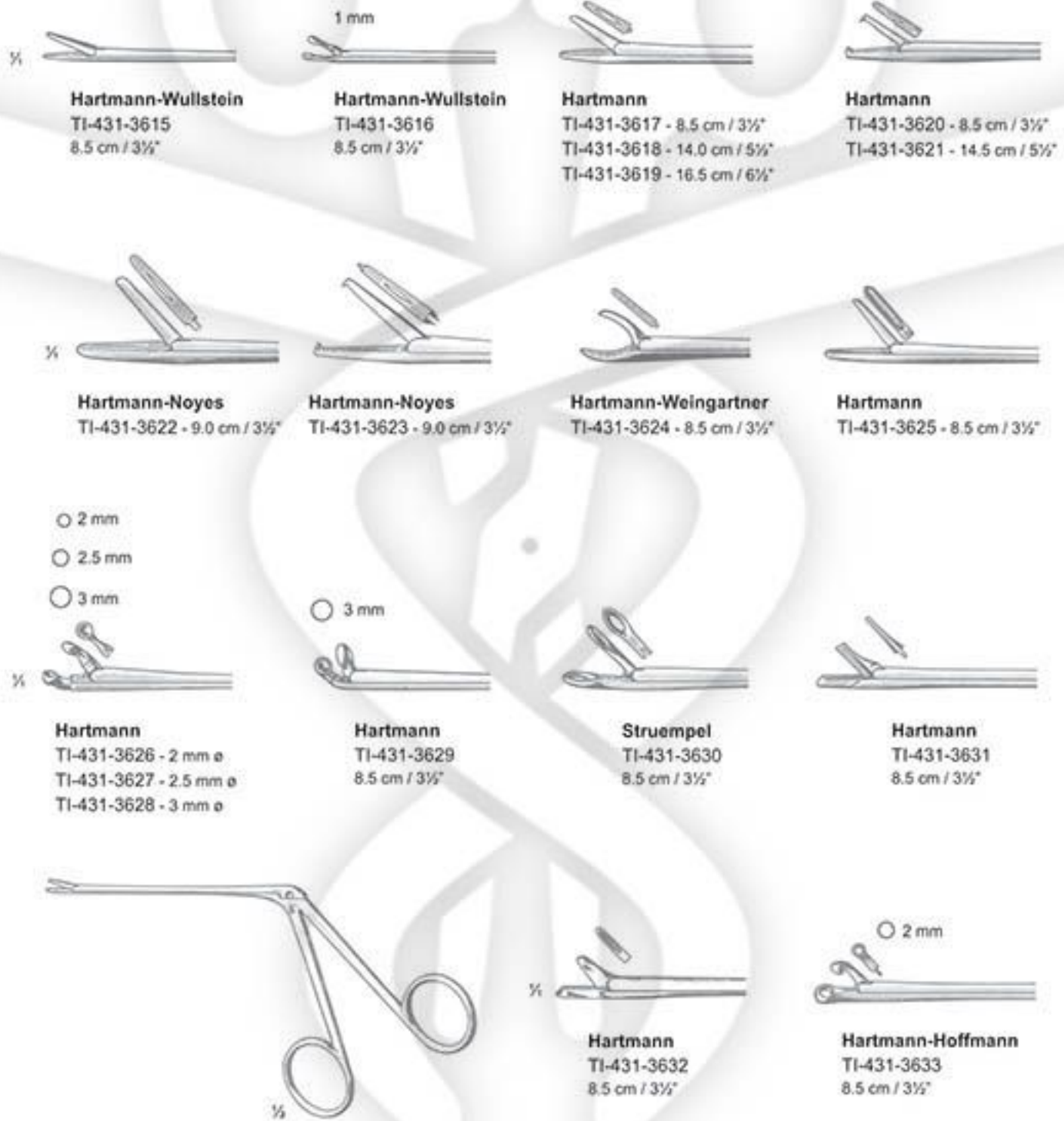

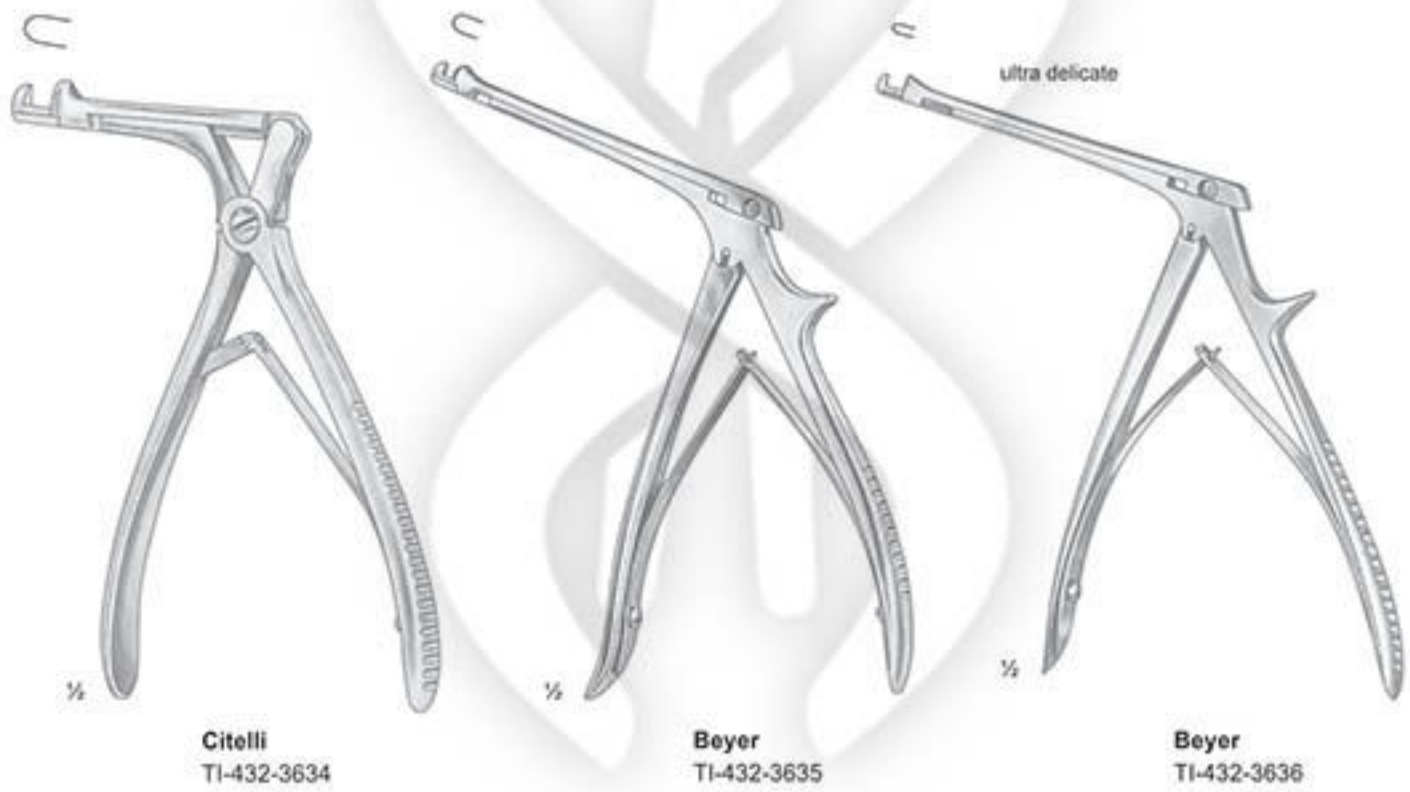



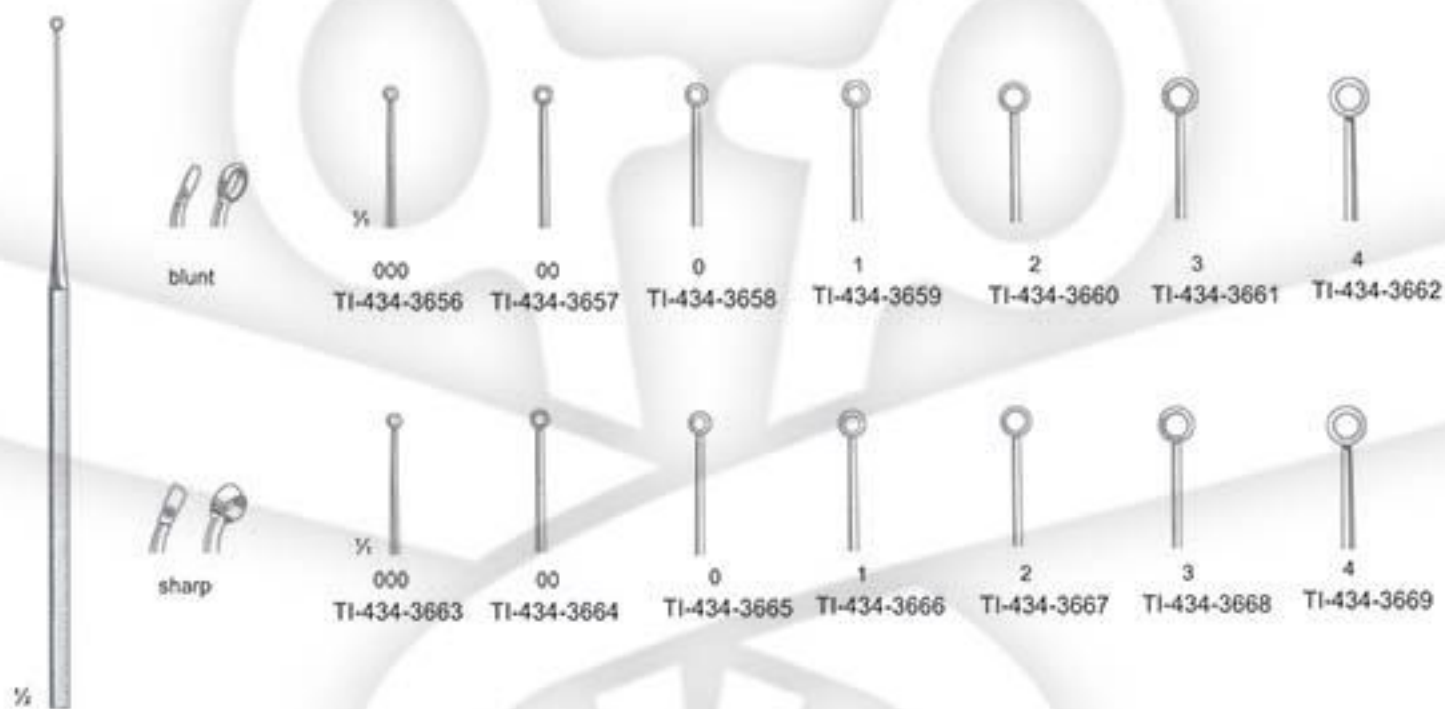

Buck
16.5 cm / 6 1/2"

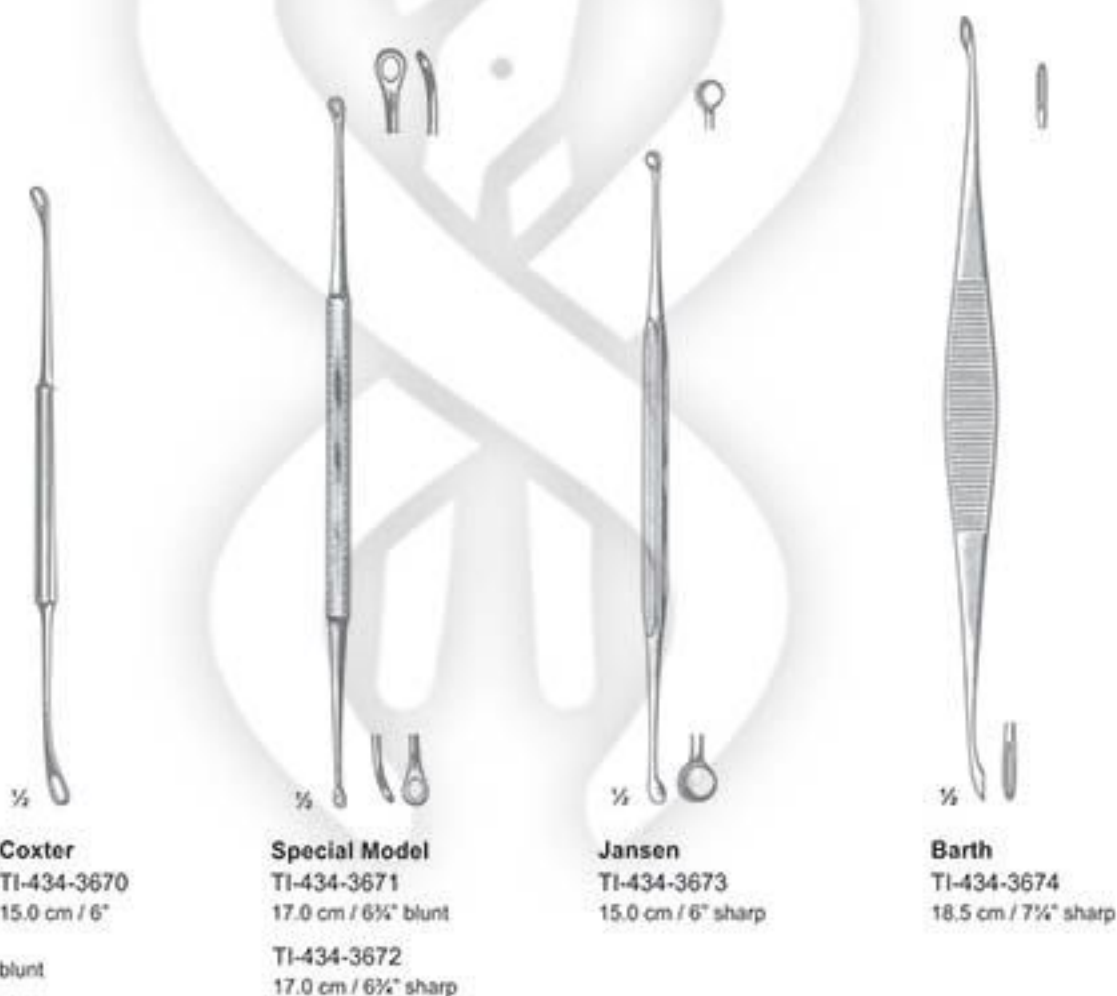



Gross
TI-435-36675
12.0 cm / 4 3/4"

blunt



16.0 cm / 6 1/4"



TI-435-3676



TI-435-3677



Billeau
16.5 cm / 6 1/2"



TI-435-3678



TI-435-3679



TI-435-3680



Moldenhauer
TI-435-3681
16.5 cm / 6 1/2"



Zaufal
TI-435-3682
16.0 cm / 6 1/4"



Hartman
TI-435-3683
16.0 cm / 6 1/4"



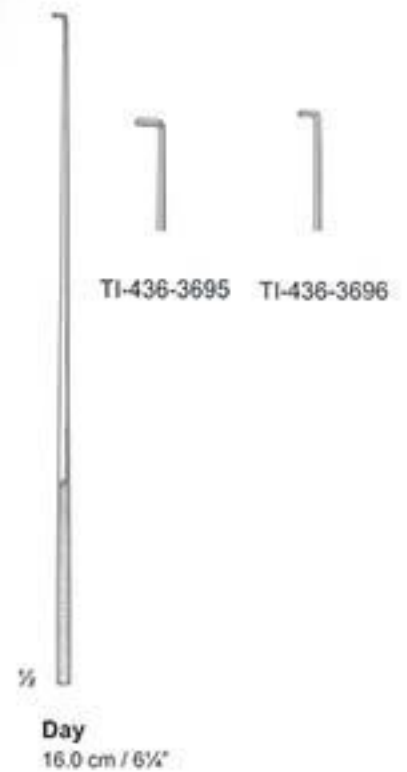
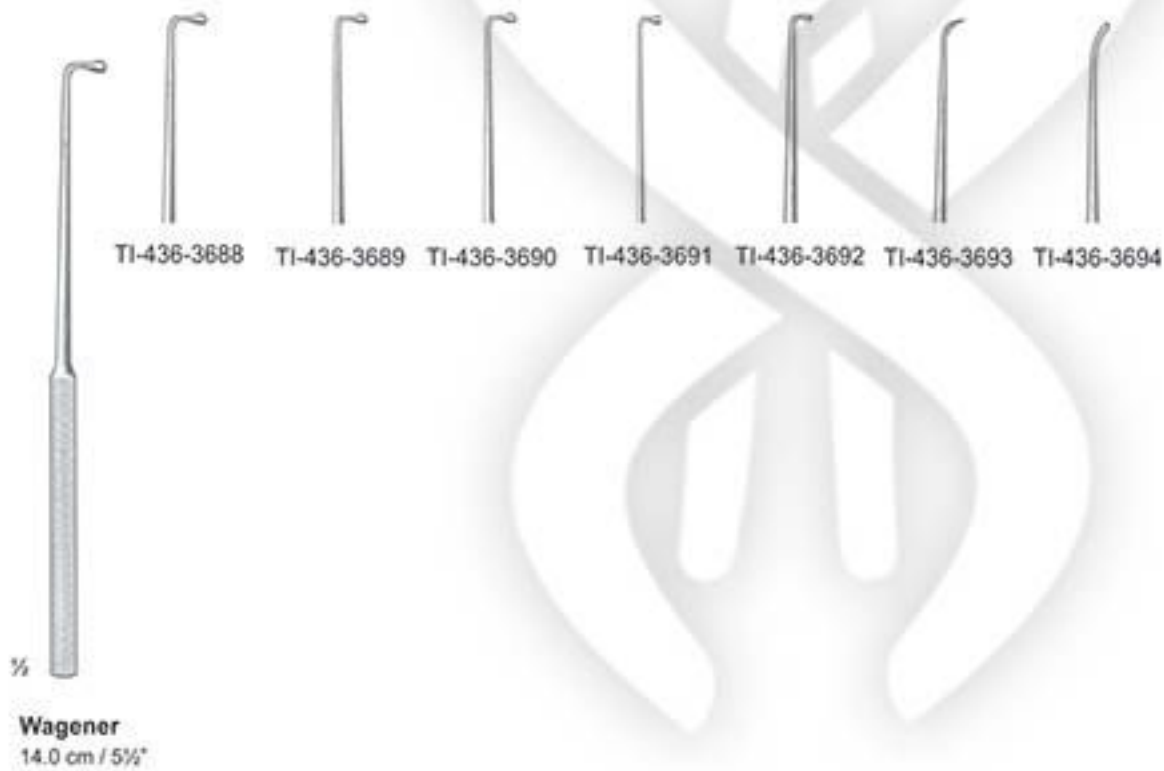
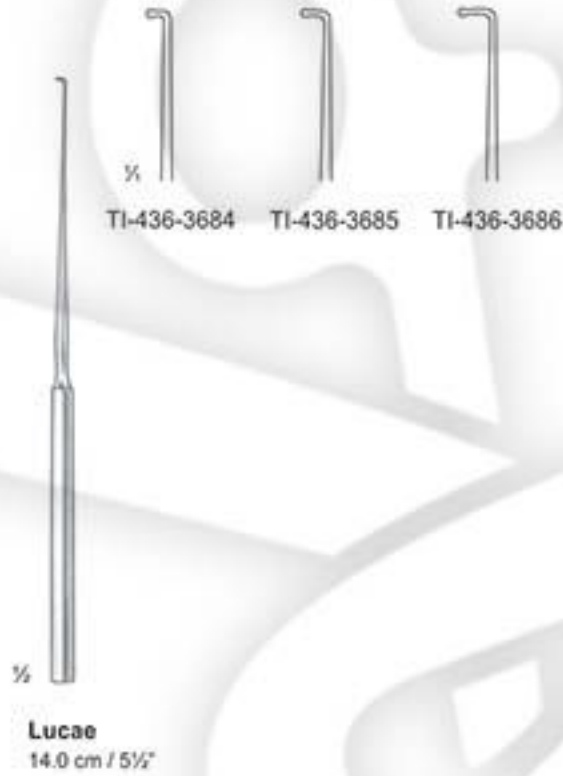

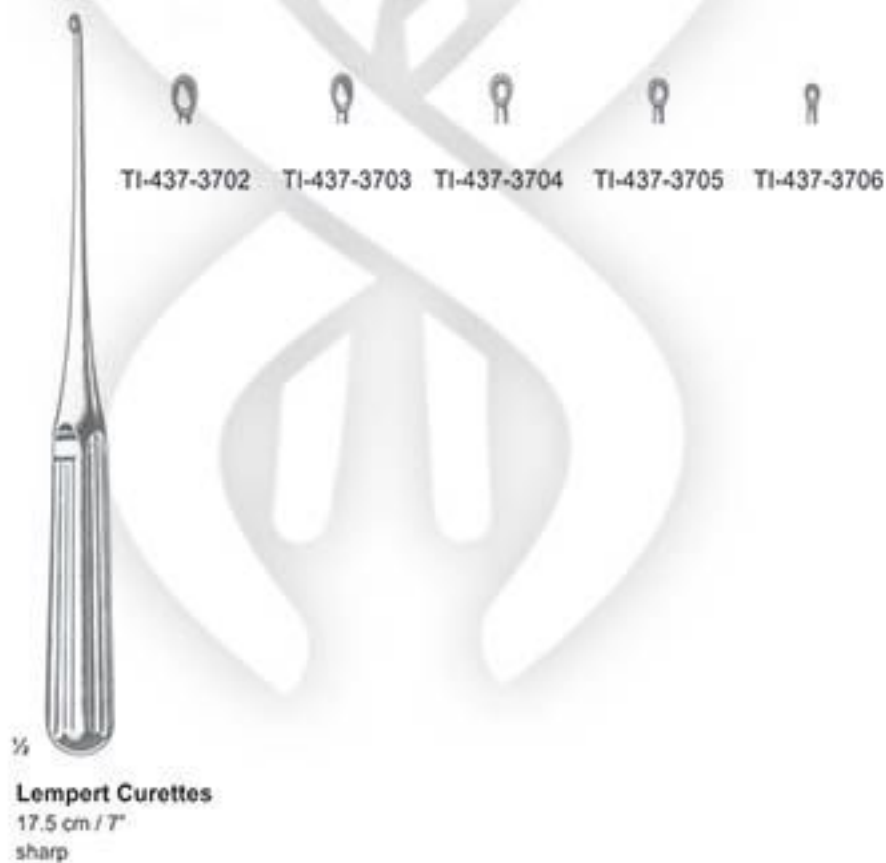
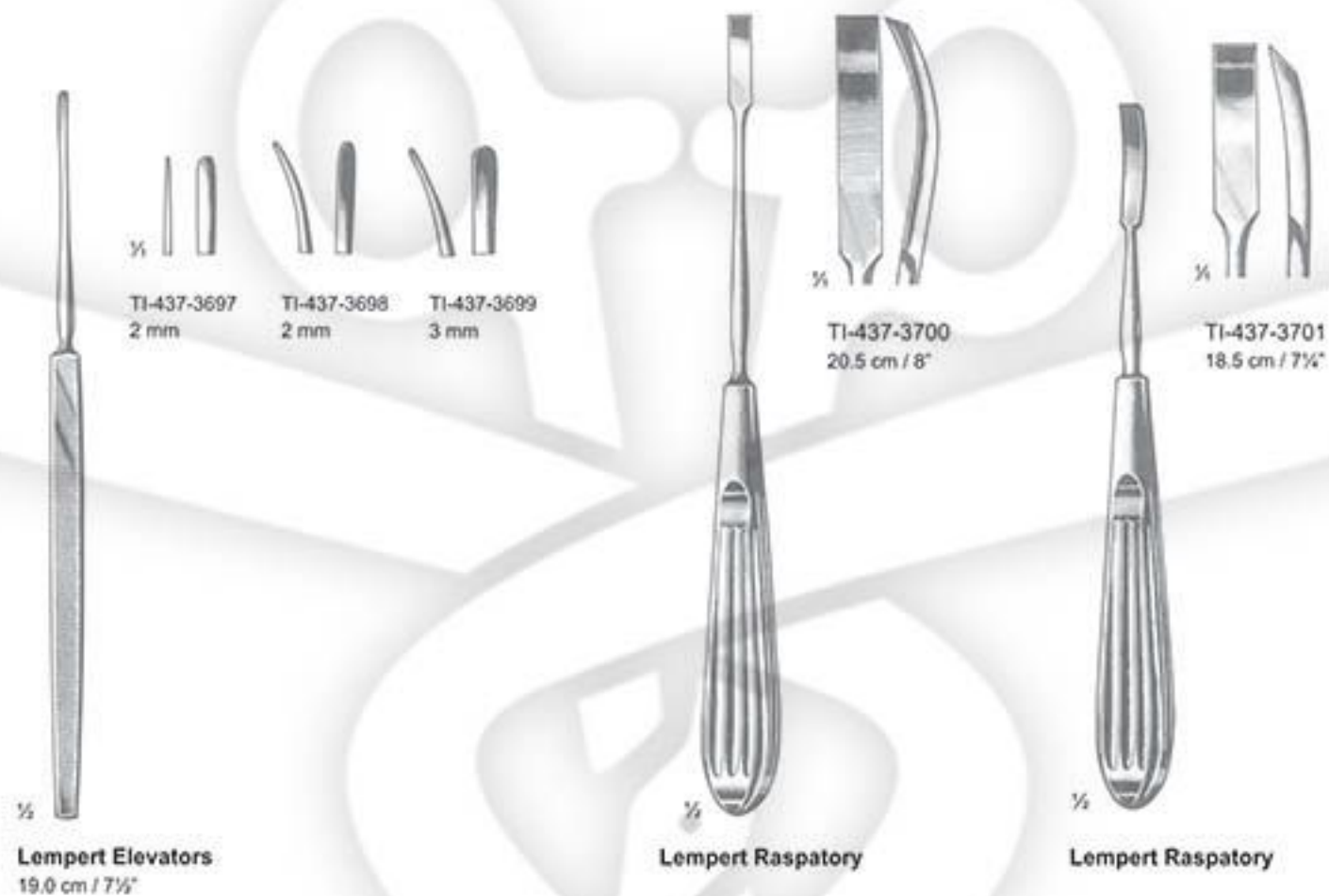

18

ORAL & FACIAL SURGERY INSTRUMENTS





Heister
TI-438-3707
13.0 cm / 5"



Molt
TI-438-3708
11.0 cm / 4 1/4"



Molt
TI-438-3709
14.0 cm / 5 1/2"



Denhart
TI-438-3710
12.0 cm / 4 3/4"



Roser-Konig
TI-438-3711 - 16.0 cm / 6 1/4"
TI-438-3712 - 19.0 cm / 7 1/2"

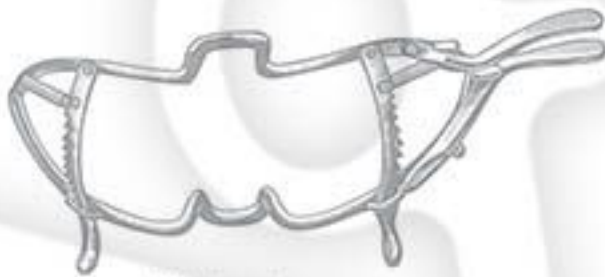

Whitehead
TI-439-3713 - 11.0 cm / 4 1/2"
TI-439-3714 - 13.0 cm / 5"
TI-439-3715 - 15.0 cm / 6"



Whitehead
TI-439-3716 - 13.0 cm / 5"



Jennings
TI-439-3717 - 9.0 cm / 3 1/2"
TI-439-3718 - 11.0 cm / 4 1/2"
TI-439-3719 - 13.0 cm / 5"
TI-439-3720 - 15.0 cm / 6"



**Seemann-Seiffert
(Self-retaining)**
TI-439-3721 - 9.0 cm / 3 1/2"
TI-439-3722 - 11.0 cm / 4 1/2"
TI-439-3723 - 13.0 cm / 5"
TI-439-3724 - 15.0 cm / 6"

Tongue Depressors



Kilner-Doughty
complete with frame
TI-439-3725



TI-439-3726
Fig. 1



TI-439-3727
Fig. 2



TI-439-3728
Fig. 3



TI-439-3729

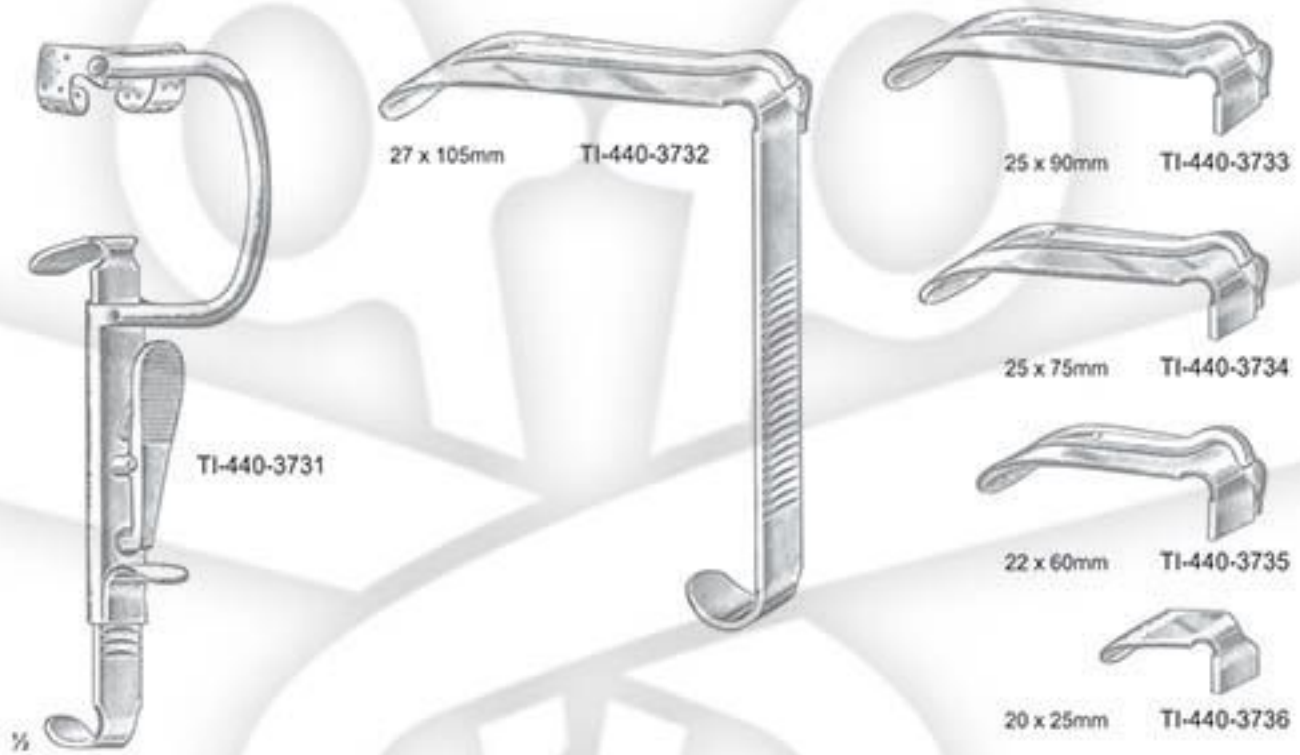

Davis-Boyle
TI-440-3730
complete with 5 blades



Mcivor
TI-440-3737
complete with 3 blades



Dingman Mouth Gag
TI-441-3742
complete with 3 tongue blades

Dingman Tongue Gag
TI-441-3743
Small: 24mm x 52mm
complete with 3 tongue blades
TI-441-3744
Medium: 28mm x 55mm
TI-441-3745
Large: 30mm x 68mm



Collin
TI-441-3746
17.0 cm / 6 1/2"

Guy
TI-441-3747
19.0 cm / 7 1/2"

Young
TI-441-3748
17.0 cm / 6 1/2"



1/2
TI-441-3749
pair



1/2
Moritz-Schmidt
TI-442-3750
19.0 cm / 7 1/2"



1/2
Hartmann
TI-442-3751
15.0 cm / 6"



1/2
Tobold
TI-442-3752
14.0 cm / 5 1/2"



1/2
Tobold
TI-442-3753
14.0 cm / 5 1/2"



1/2
Andrew
TI-442-3754
11.0 cm / 4 1/2"



1/2
Wieder



1/2
TI-442-3755
14.0 cm / 5 1/2"



TI-442-3756
15.0 cm / 6"

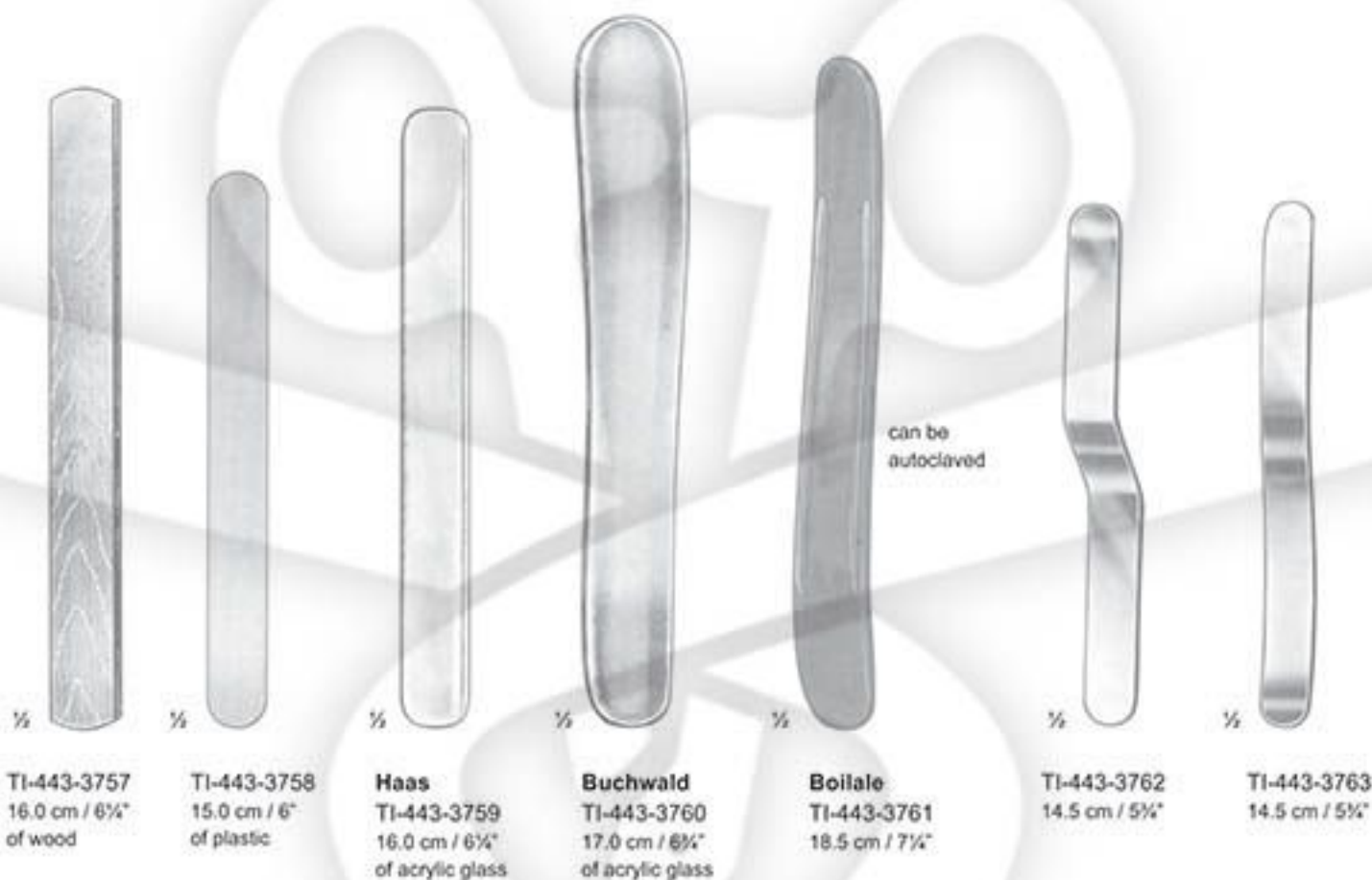

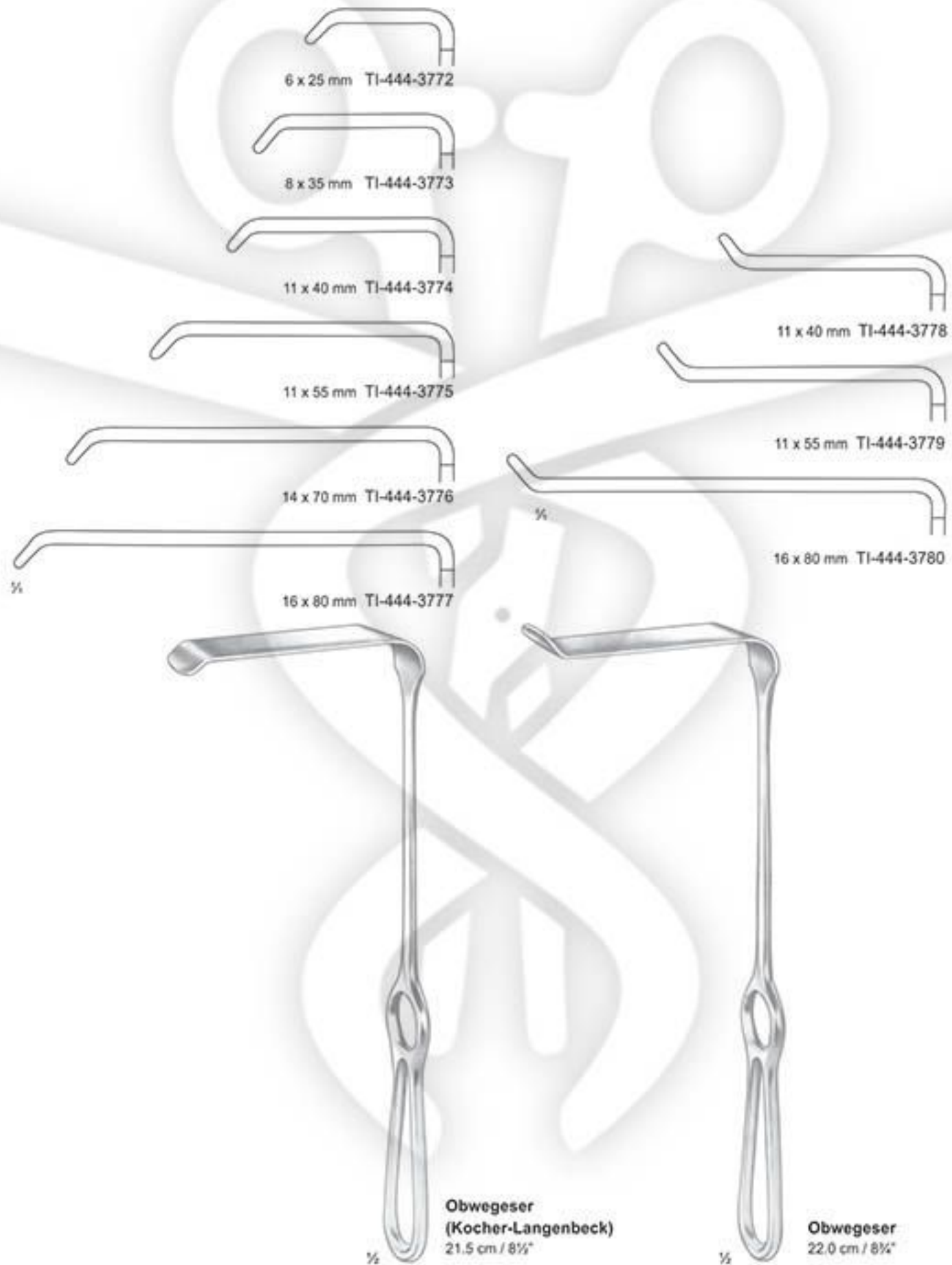



Obwegeser
TI-445-3781
16.0 cm / 6 1/4"



Obwegeser
TI-445-3782 - 8 mm
TI-445-3783 - 10 mm
16.0 cm / 6 1/4"

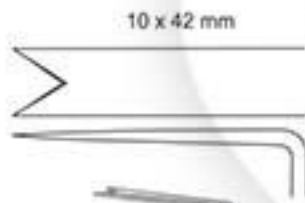

Obwegeser
TI-445-3784
22.0 cm / 8 1/4"



Obwegeser
TI-445-3785
22.0 cm / 8 1/4"



Obwegeser
17.5 cm / 7"

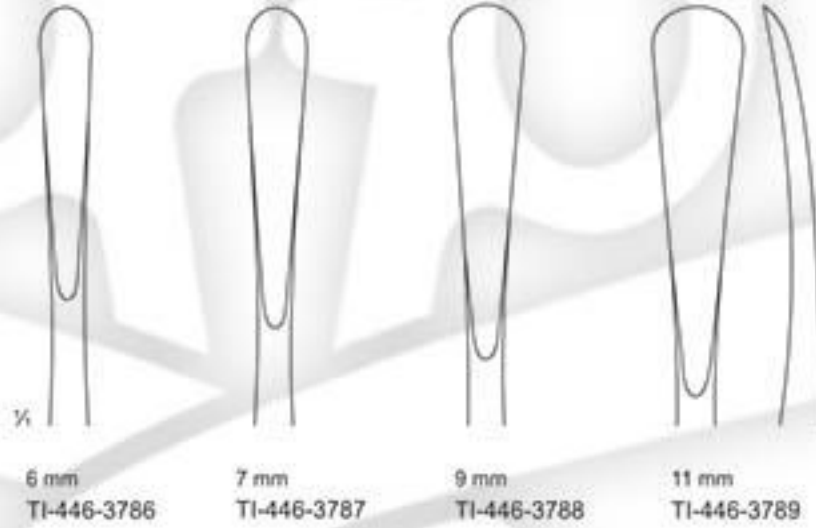

Obwegeser
20.0 cm / 8"

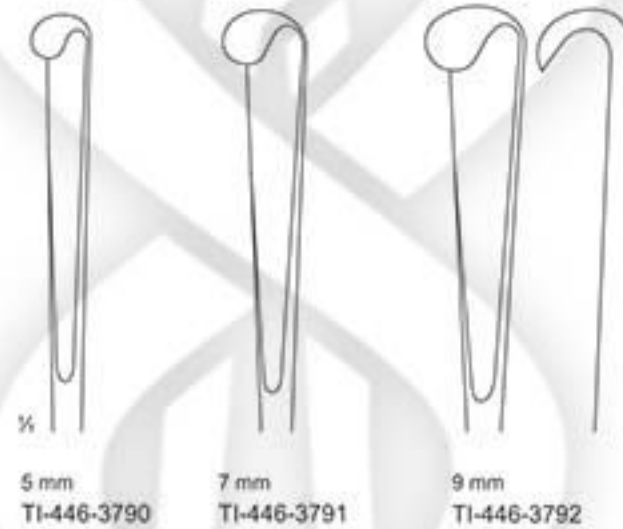

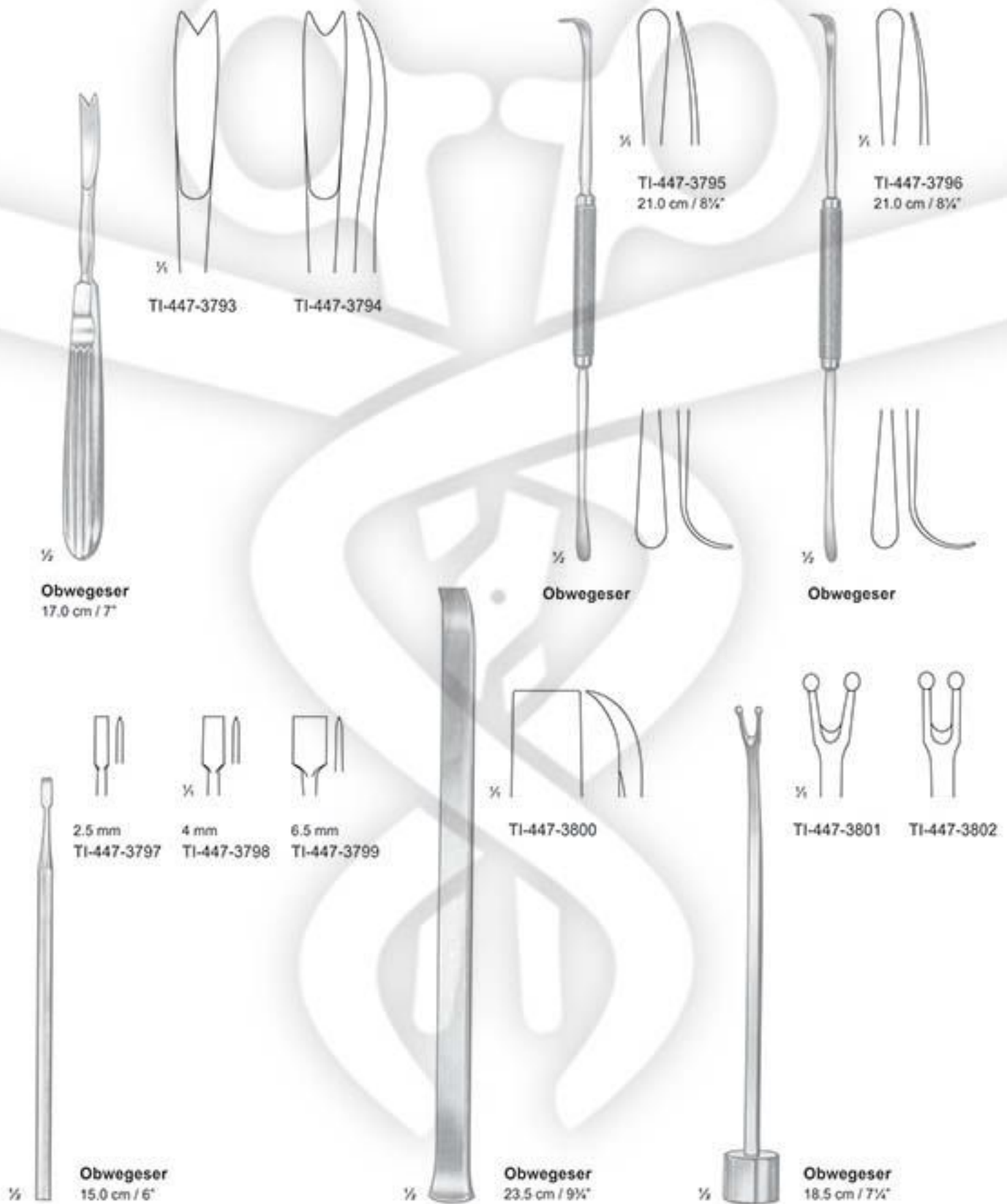



Obwegeser
TI-448-3803 - 18.0 cm / 7"
TI-448-3804 - 28.0 cm / 11"



Obwegeser
TI-448-3805
13.0 cm / 5"



Obwegeser
TI-448-3806
23.0 cm / 9"



TI-449-3807
TI-449-3808



TI-449-3809
TI-449-3810



TI-449-3811
TI-449-3812



19

TONSILS & LARYNGO INSTRUMENTS

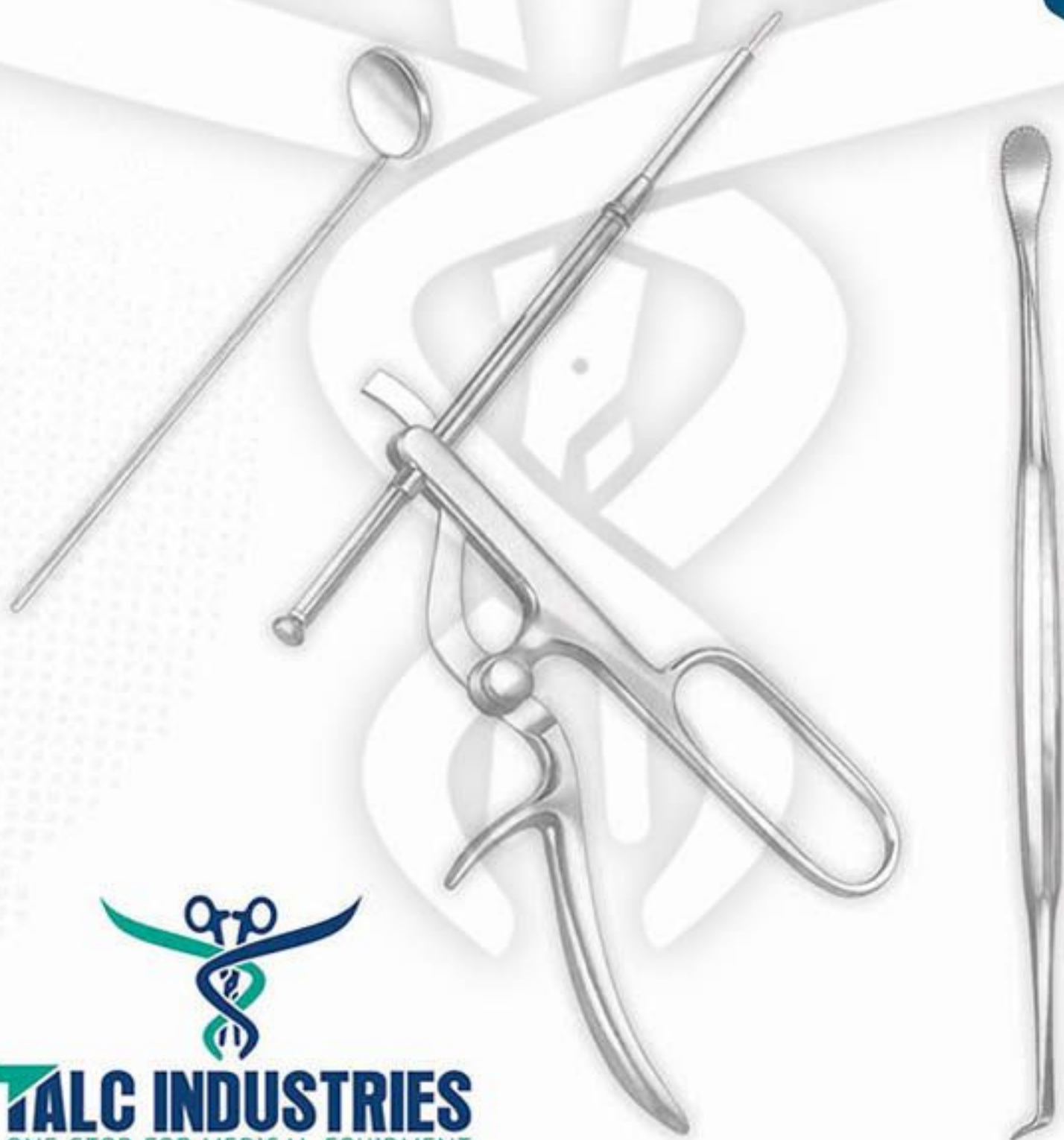



1/2

Fisher
TI-450-3813
23.0 cm / 9"

1/2

Abraham
TI-450-3814
21.0 cm / 8 1/4"

1/2

Bruenings
TI-450-3815
23.0 cm / 9"



Carpenter
TI-451-3816
25.0 cm / 10"



Carpenter
TI-451-3817
24.0 cm / 9 1/2"



Hurd
TI-451-3818
23.0 cm / 9"



Henke
TI-451-3819
23.0 cm / 9"



Henke
TI-451-3820
23.0 cm / 9"

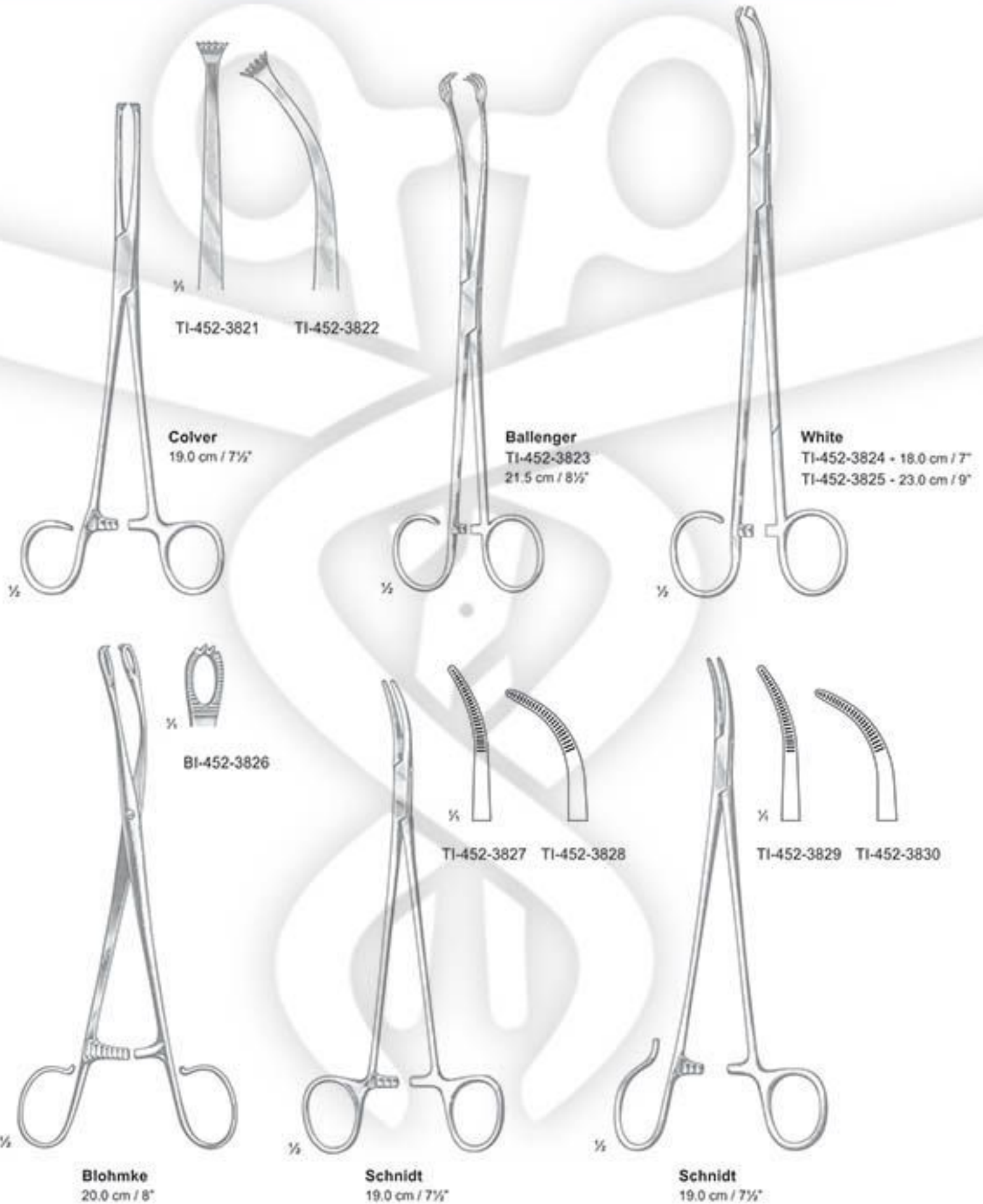

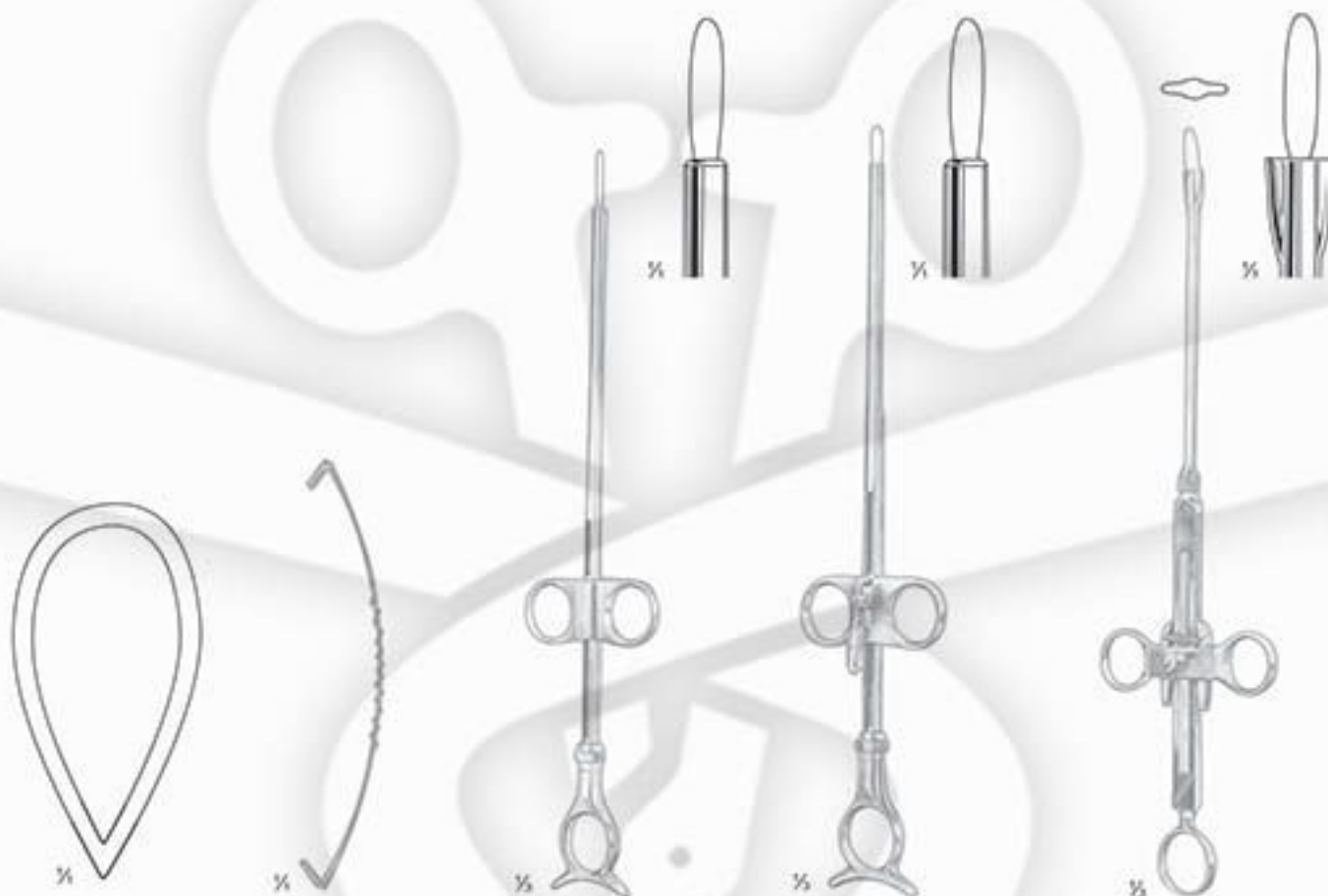

TI-453-3831 - 40 mm
TI-453-3832 - 50 mm

TI-453-3833
0.3 mm a

Eves
TI-453-3834
28.0 cm / 11"

Eves
TI-453-3835
28.0 cm / 11"

Bruenings
I-453-3836
28.0 cm / 11"

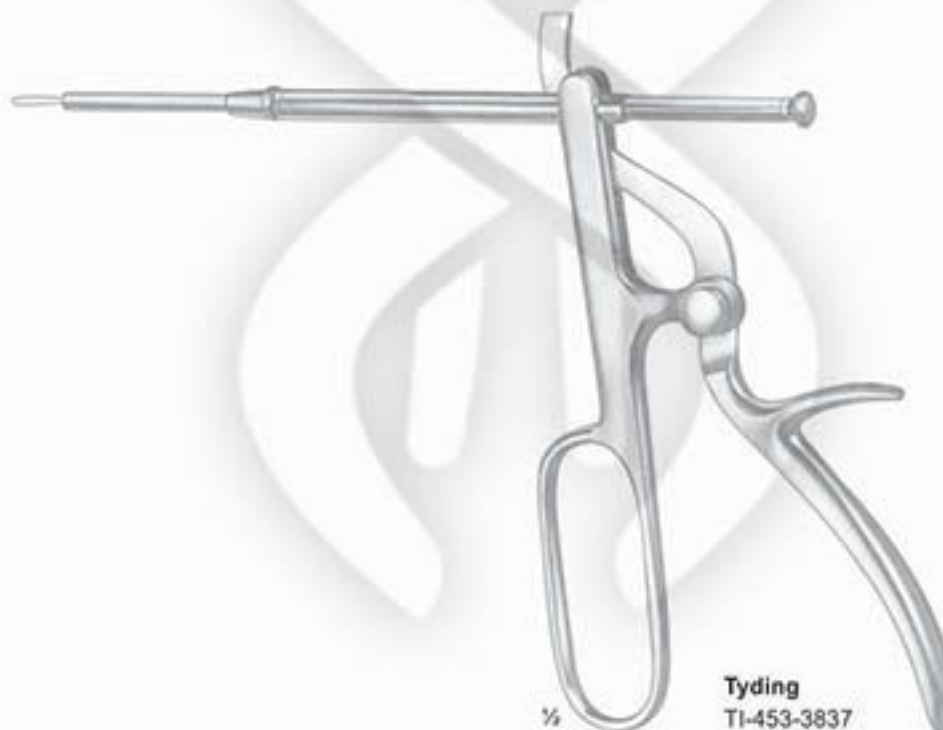

Tyding
TI-453-3837
with 1 straight tip



Fig. 1



Fig. 2

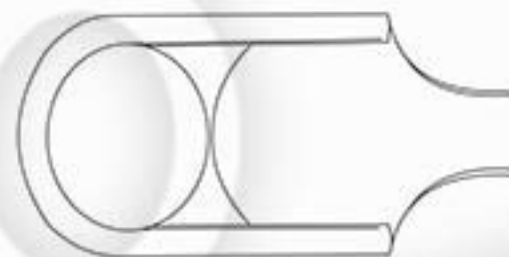
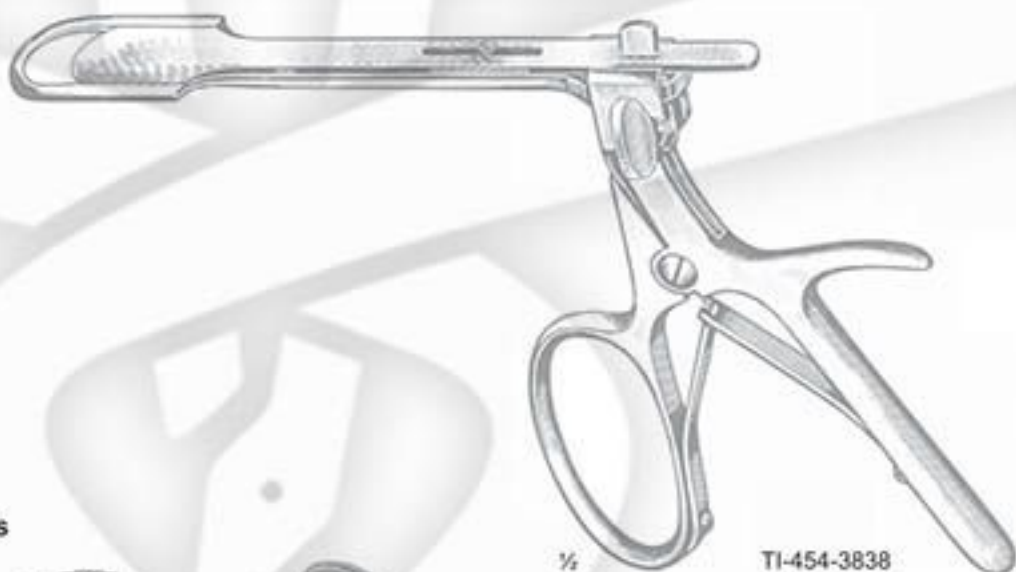

Fig. 3



1/2

TI-454-3838

complete with 3 tip

Laryngeal Mirrors



1/2



TI-454-3839	Fig.00	=	8 mm ø	TI-454-3851
TI-454-3840	Fig.0	=	10 mm ø	TI-454-3852
TI-454-3841	Fig.1	=	12 mm ø	TI-454-3853
TI-454-3842	Fig.2	=	14 mm ø	TI-454-3854
TI-454-3843	Fig.3	=	16 mm ø	TI-454-3855
TI-454-3844	Fig.4	=	18 mm ø	TI-454-3856
TI-454-3845	Fig.5	=	20 mm ø	TI-454-3857
TI-454-3846	Fig.6	=	22 mm ø	TI-454-3858
TI-454-3847	Fig.7	=	24 mm ø	TI-454-3859
TI-454-3848	Fig.8	=	26 mm ø	TI-454-3860
TI-454-3849	Fig.9	=	28 mm ø	TI-454-3861
TI-454-3850	Fig.10	=	30 mm ø	TI-454-3862



cm	in	TI-455-3863	TI-455-3867	TI-455-3871	TI-455-3875	TI-455-3879	TI-455-3883	TI-455-3887
30	12	TI-455-3864	TI-455-3868	TI-455-3872	TI-455-3876	TI-455-3880	TI-455-3884	TI-455-3888
40	16	TI-455-3865	TI-455-3869	TI-455-3873	TI-455-3877	TI-455-3881	TI-455-3885	TI-455-3889
50	20	TI-455-3866	TI-455-3870	TI-455-3874	TI-455-3878	TI-455-3882	TI-455-3886	TI-455-3890
60	24							



Universal Detachable Handles,
for use with interchangeable tip and tubes



straight	lengths	
	cm	in.
TI-455-3893	20	8
TI-455-3894	30	12
TI-455-3895	40	16



Laryngeal Tube for above mentioned handle



Fraenkel
TI-456-3897



Seiffert
TI-456-3898



Fraenkel
TI-456-3899



Scheinmann
TI-456-3900



Scheinmann
TI-456-3901

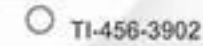

Bruenings

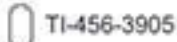

Bruenings



Lange
BI-456-3906

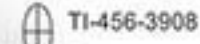
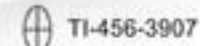

Krause

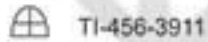
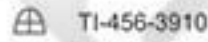

Krause
TI-456-3909



Cordes



with drawing cut



Schumacher
TI-456-3914



TI-456-3915



TI-456-3916



Cordes



Cordes
TI-456-3917



Rosenberg
TI-456-3918

20

ANAESTHESIA INSTRUMENTS



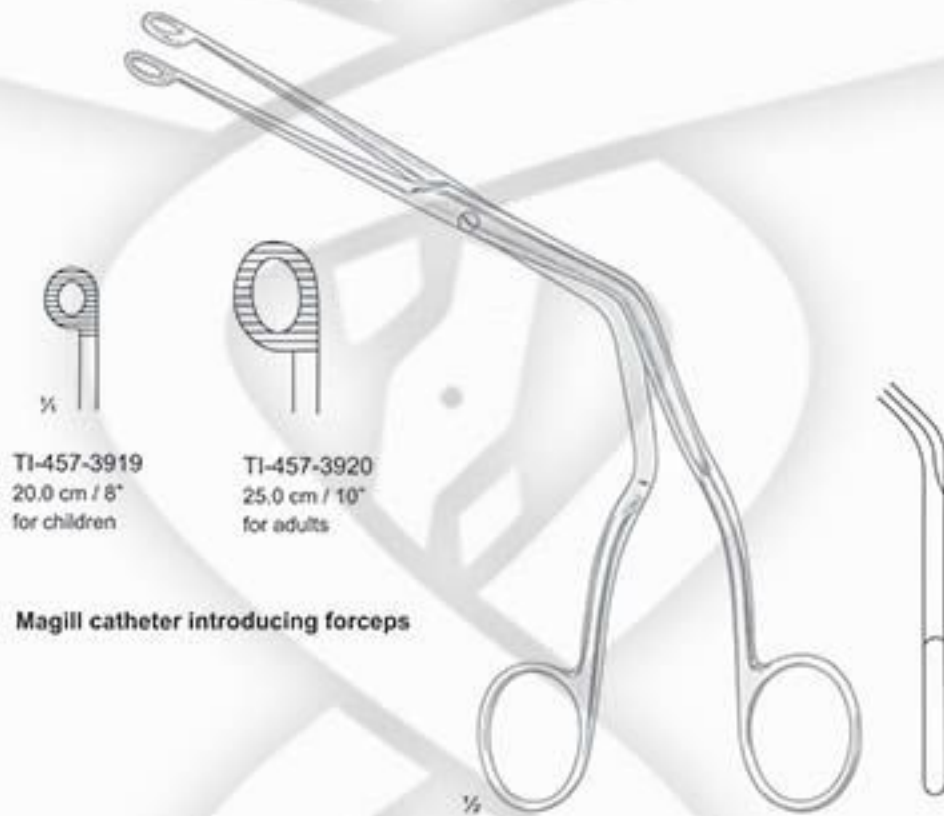



McIntosh
TI-458-3921

Laryngoscope set
consisting of
Battery Handle (without batteries)
& 4 blades



TI-458-3922



TI-458-3923



TI-458-3924



TI-458-3925



TI-458-3926



McIntosh Fiber Optical
TI-459-3927

Laryngoscope set
consisting of
Battery Handle (without batteries)
& 4 blades



TI-459-3929



TI-459-3930



TI-459-3931



TI-459-3932



TI-459-3928



McIntosh Fiber Optical
TI-460-3933

Laryngoscope set
consisting of
Battery Handle (without batteries)
& 4 blades



TI-460-3934



TI-460-3935



TI-460-3936



TI-460-3937



TI-460-3938



Miller Fiber Optical
TI-461-3944

Laryngoscope set
consisting of
Battery Handle (without batteries)
& 4 blades



TI-462-3945



TI-462-3946



TI-462-3947



TI-462-3948



TI-462-3949



Miller
TI-461-3950

Laryngoscope set
consisting of
Battery Handle (without batteries)
& 4 blades



21

ENDOSCOPIC INSTRUMENTS

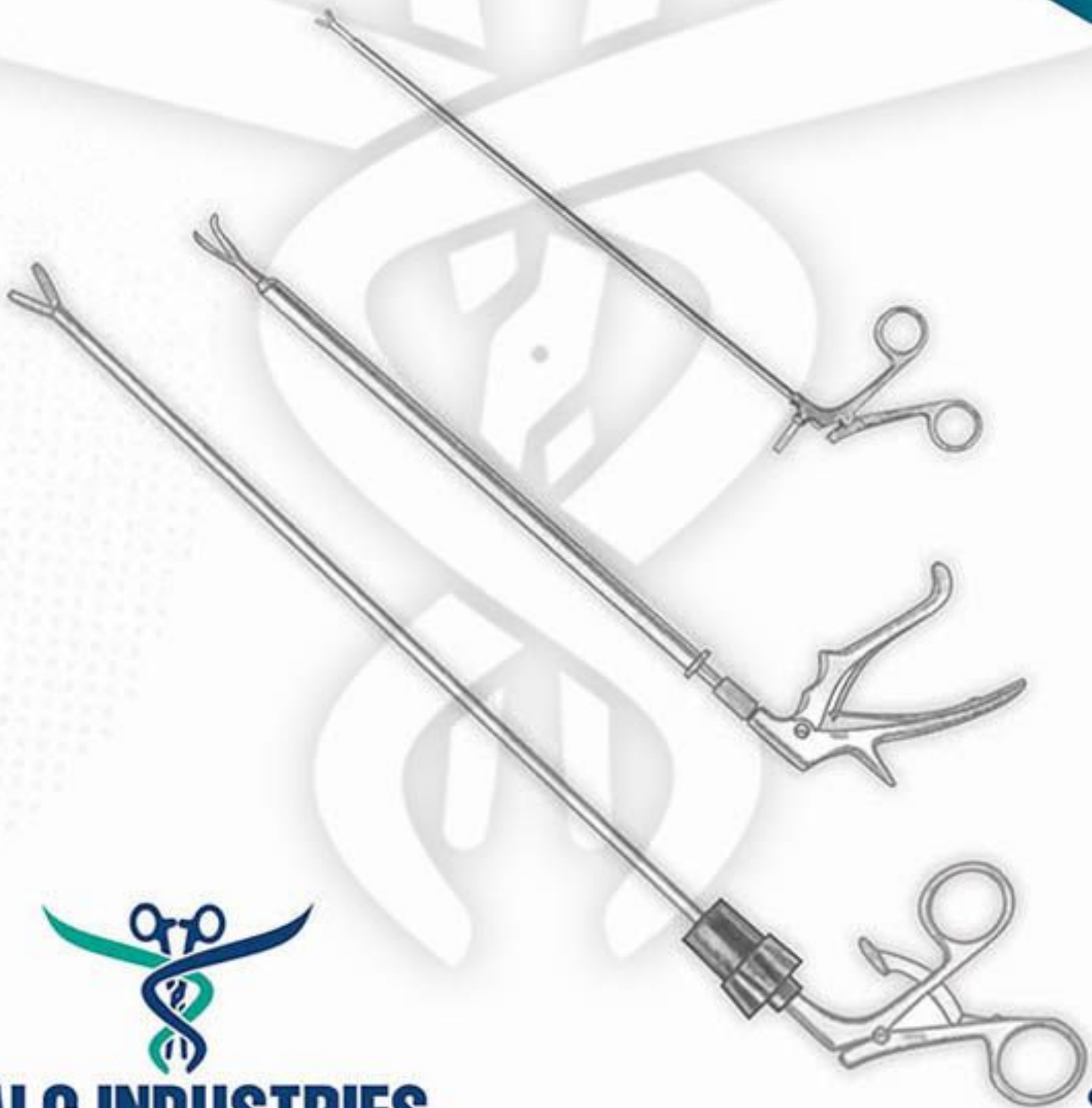



Otoscope Fiber Optic (Pocket)
TI-464-3952
2.5 V Halogen Light
Fiber Optic for Obstruction free
Light Sealed System with Insufflator
Fitting for Pneumatic Otoscope.
Otoscope Head Made from Polymid
7 Disposable Polypropyleni Ear Spcula
Colours: Black, Blue, Pink, Green.



Mini Otoscope Fiber Optic (Pocket)
TI-464-3953
2.5 V Halogen Light
Fiber Optic for Obstruction free
Light Sealed System with Insufflator
Fitting for Pneumatic Otoscope.
Otoscope Head Made from Polymid



Otoscope
TI-464-3954
Boyonet locking mounts for each instruments
head to allow secure connection to battery handle.
Rheostatic ON / OFF Switch.
Otoscope with 3 Ear specula.



Ent Dignostic set
TI-464-3955
Boyonet locking mounts for each
instruments head to allow secure
connection to battery handle.
Rheostatic ON / OFF Switch.
Otoscope with 3 Ear specula
& Nasal Speculam with manual
screw opning.
Ophthalmoscope head with lens wheel
featuring 25 corective lenses.
Chrome plated bent arm larynx
with light.
2 mirrirs 4mm & 5mm.
Disposable tongue depressor with holder.



Grasping Forceps
Straight, serrated jaws with proximal recess, double action.



TI-465-3959
Roto-Lok, ratchet,
5mm, 32cm



TI-465-3956
Ratchet, insulated shaft,
5mm, 32cm



TI-465-3960
Roto-Lok, locking lever,
5mm, 32cm



TI-465-3957
Monopolar,
5mm, 32cm

TI-465-3958
Monopolar,
5mm, 45cm



TI-465-3961
Roto-Cam, monopolar,
5mm, 32cm

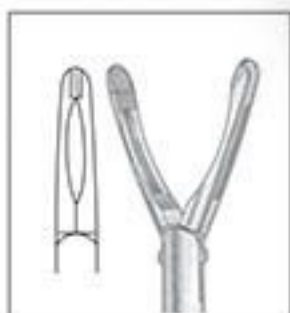

Tc Grasping Forceps
Double action
Carb-Bite tips, 22mm long jaws maintain firm grasp on delicate tissue, double action.



TI-465-3962
Roto-Lok, ratchet,
5mm, 32cm



TI-465-3963
Roto-Lok, locking lever,
5mm, 32cm

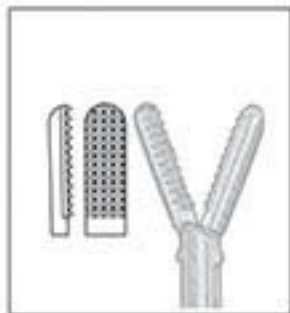

Strong Tc Grasping Forceps
Heavy Carb-Bite inserts allow jaws to maintain firm hold on tissue, double action.



TI-465-3964
Roto-Lok, ratchet,
5mm, 37cm



TI-465-3965
Roto-Lok, locking lever,
5mm, 37cm



Grabber Forceps
long, fenestrated jaws
with interlocking wave-like
serrations for strong hold,
double action



Fundus Grabber Forceps
long, beveled-edge jaws
permit a large purchase
on tissue and maintain
a strong hold.

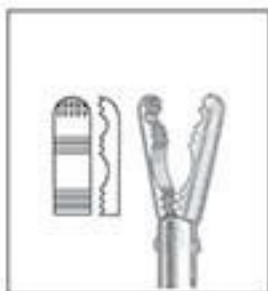
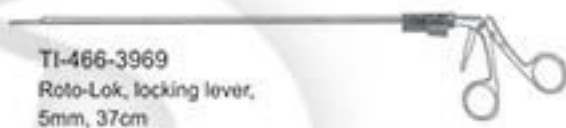

Dual-Cup Grabber Forceps
Double cup design
increases surface area
contact which improves
hold on tissue, double action.

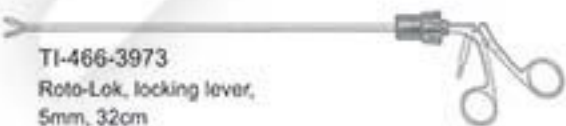



Retraction Grasping Forceps

Long-ridged jaws with 2 x 3 blunt interdigitating teeth for strong grasp of heavy tissue.



TI-467-3976
Roto-Lok, ratchet,
5mm, 37mm



TI-467-3977
Roto-Lok, locking lever,
5mm, 37mm



TI-467-3978
Double action,
Roto-Lok, locking lever,
5mm, 37mm



TI-467-3979
Double action,
Roto-Lok, ratchet,
5mm, 37mm



Atrau-Allis Grasping Forceps

Unique jaw design offers strong atraumatic grasp, double action.



TI-467-3980
Roto-Lok, ratchet,
5mm, 32mm



TI-467-3974
Ratchet, insulated shaft,
5mm, 32mm

TI-467-3975
Ratchet, insulated shaft,
5mm, 45mm



TI-467-3981
Roto-Lok, locking lever,
5mm, 32mm



Atrau-Allis LJ Grasping Forceps

Unique jaw design in 20mm length offers strong atraumatic grasp, double action.



TI-467-3982
Roto-Lok, ratchet,
5mm, 37mm

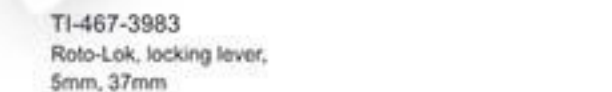

TI-467-3983
Roto-Lok, locking lever,
5mm, 37mm



Allis Grasping Forceps

Interlocking distal teeth with fine-serrated inner jaws, double action.



TI-468-3984
Ratchet, insulated shaft,
5mm, 32mm



TI-468-3985
Roto-Lok, ratchet,
5mm, 32mm

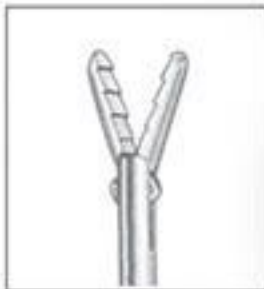

Retrograde Grasping Forceps

Retrograde, deep-serrated teeth allow for non-slip hold, double action.



TI-468-3986
Ratchet,
5mm, 32mm



Grasping and Dissecting Forceps

Cup-shaped, toothed jaws, double action.



TI-468-3987
Monopolar
5mm, 32mm



Grasping and Extracting Forceps

Retrograde, deep-serrated teeth



TI-468-3988
Spring-loaded
10mm, 32mm



Claw Forceps
2x3 interlocking teeth
for penetrating hold and
extraction of tissue.



TI-469-3989
Spring-loaded
10mm, 32mm



Claw Forceps
2x3 interlocking teeth
for penetrating hold and
extraction of tissue.



TI-469-3990
Spring-loaded
5mm, 32mm

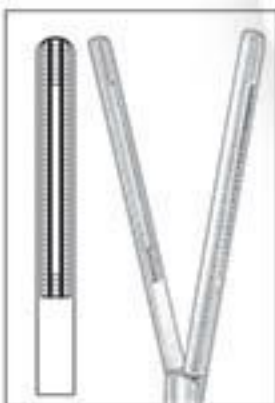

Debakey Forceps
Fenestrated 45mm long jaws
with Debakey-type teeth,
double action.



TI-469-3991
Ratchet,
5mm, 32mm



Debakey Forceps
Fenestrated 55mm long jaws
with Debakey-type teeth,
double action.



TI-469-3992
Roto-Lok, ratchet,
10mm, 37mm



Paddle Babcock Forceps

Flat paddles with fine, straight serrations for atraumatic hold of delicate tissue, double action.



TI-470-3993
Roto-Lok, ratchet,
10mm, 37mm



Paddle Babcock Forceps

Flat paddles with fine, straight serrations for atraumatic hold of delicate tissue, double action.



TI-470-3994
Roto-Lok, ratchet,
5mm, 37mm



TI-470-3995
Roto-Lok, locking lever,
5mm, 37mm



Babcock Forceps

Traditional style Babcock jaws designed with six rows of fine serrations for atraumatic, yet secure grasp of bowel and other delicate tissue, double action.



TI-470-3996
Roto-Lok, ratchet,
10mm, 37mm



Babcock Forceps

Rounded jaws with 2x3 rows of De-Bakey-type teeth for atraumatic, yet secure grasp of bowel and other delicate tissue, double action.



TI-470-3997
Ratchet,
10mm, 32mm



TI-470-3998
Roto-Lok, ratchet,
10mm, 32mm



Babcock Forceps

Traditional design for grasping delicate tissue, double action.



TI-471-3999
Ratchet
5mm, 32cm



TI-471-4000
Roto-Lok, ratchet
5mm, 32cm



TI-471-4001
Roto-Lok, locking lever,
5mm, 37cm



Swanstron Grasping Forceps

Unique design of 1x2 De-Bakey-type teeth with triangular fenestration provides an effective hold with atraumatic grasp, double action.



TI-471-4002
Roto-Lok, ratchet,
5mm, 37cm



TI-471-4003
Roto-Lok, locking lever,
5mm, 37cm



Duval Grasping Forceps

Triangular jaws with deep-serrated surfaces for non-slip, firm grasp of tissue, double action.



TI-471-4004
Ratchet,
10mm, 32cm



TI-471-4005
Roto-Lok ratchet,
10mm, 32cm



Russian Grasping Forceps

40mm long jaws with heavy serration for effective tissue, double action.



TI-472-4006
Ratchet,
10mm, 32cm



Foerster Sponge Forceps

45mm jaws firmly hold tissue, double action.



TI-472-4007
Ratchet,
10mm, 32cm



Hunter[®] Clamps

Right-angle shaft with Atrau-Allis teeth for secure grasp and manipulation of tissue around structures, e.g stomach/esophagus in fundoplication, double action.



TI-472-4008
Ratchet,
5mm, 32cm



Hunter[®] Bowel Grasper

Fenestrated, 20mm jaws for atraumatic manipulation of delicate tissue, e.g bowel stomach, double action.



TI-472-4009
Roto-Lok,
5mm, 32cm



Stone Extractor

To facilitate stone removal once neck of gallbladder has been externalized.

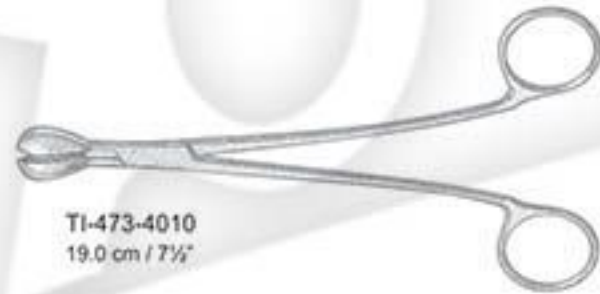

TI-473-4010
19.0 cm / 7 1/2"



Stone Extractor

Fenestrated, serrated, oval-shaped jaws that converge at distal end to prevent slippage, double action.

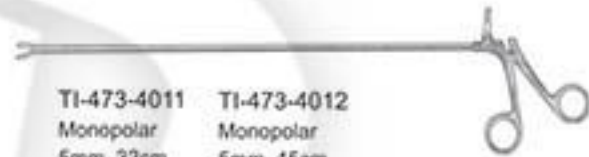

TI-473-4011	TI-473-4012
Monopolar	Monopolar
5mm, 32cm	5mm, 45cm



Strong Atraumatic Grasping Forceps

Fenestrated, serrated, curved jaws with split-steel construction, for fixation of ovary or manipulation of pelvic tissues.



TI-473-4013	TI-473-4014
Spring handle	Spring handle
5mm, 32cm	5mm, 45cm



Micro Dissecting Forceps

Delicate, fenestrated, serrated jaws for gentle blunt dissection, double action.



TI-474-4015
Monopolar
5mm, 32cm



TI-474-4016
Roto-Cam, monopolar
5mm, 32cm



Needle Nose Forceps

Slender, tapered and fine-serrated jaws.



TI-474-4017
Monopolar
5mm, 32cm



Tapered Dissecting Forceps

Tips of serrated, tapered jaws meet at fine point to allow delicate, yet firm, grasp and dissection of thin adventitial tissue, double action.



TI-474-4018
Monopolar
5mm, 32cm



TI-474-4019
Roto-Cam, monopolar
5mm, 32cm



Micro Grasping Forceps

3mm small, tapered jaws for dissection of small structures.



TI-474-4020
Monopolar
5mm, 32cm



Bullet-Nose Dissecting Forceps

Bullet-shaped, tapered, serrated jaws for dissection, double action.



TI-475-4021
Roto-Cam, monopolar,
5mm, 32mm



Tapered Maryland Dissecting

Curved, finely-tapered, serrated jaws with wide spread, double action.



TI-475-4022
Roto-Cam, monopolar,
5mm, 32mm



Maryland Dissecting

Curved, tapered, serrated jaws with wide spread, double action.



TI-475-4023
Monopolar,
5mm, 32mm



TI-475-4024
Roto-Cam, monopolar,
5mm, 32mm



Maryland Dissector

Slender, full-curved, long serrated jaws with wide spread, double action.



TI-475-4025
Roto-Cam, monopolar,
10mm, 32mm



Mixer Dissecting Forceps

Slender, full-curved, long serrated jaws with wide spread, double action.



TI-476-4026
10mm, 32mm



Mixer Spreader-Dissectors

Jaws design offers a true right-angle for dissection around delicate structures; double action. The distinctive ergonomic handle minimize hand fatigue while allowing the surgeon fine control for precise dissection.



TI-476-4027
Roto-Cam, monopolar
10mm, 28cm



TI-476-4028
Roto-Cam, monopolar,
right-handle, 10mm, 32cm



TI-476-4029
10mm, 28cm



Mixer Spreader-Dissectors

Jaws design offers a true right-angle for dissection around delicate structures; double action. The distinctive ergonomic handle minimize hand fatigue while allowing the surgeon fine control for precise dissection.



TI-476-4030
Roto-Cam, monopolar,
5mm, 28cm



TI-476-4031
Roto-Cam, monopolar,
ring-handle, 5mm, 32cm



Appel[®] Spreader-Dissecting Hook

Right-angle tip allows rapid blunt dissection and isolation of structures.



TI-476-4032
10mm, 40cm



Supercut Scissors

Razor-sharp upper blade with finely-serrated lower blade allows clean, precise cut without tissue slippage.



TI-477-4033
5mm, 32cm

TI-477-4034
5mm, 45cm



Supercut Endo Scissors

Electrosurgical instrument with curved, Supercut blades and precise cutting action offers mechanical cutting, electrosurgical cutting, blunt dissection, electrosurgical coagulation- all in one reusable, cost-effective instrument; double action.



TI-477-4035
Monopolar
5mm, 32cm

TI-477-4036
Monopolar
5mm, 45cm



Hook Scissors

Blades designed to lift, isolate and transect tissue.



TI-477-4037
Roto-Cam, monopolar
5mm, 32cm



TI-477-4038 TI-477-4039 TI-477-4040
Monopolar, Monopolar, Non-insulated,
5mm, 32cm 5mm, 45cm 5mm, 32cm



TI-477-4041
Roto-Cam, Monopolar,
5mm, 32cm



Micro Scissors

Fine, delicate, 3mm blades for small incision.



TI-477-4042
Curved Left,
5mm, 32cm



TI-477-4043
Straight,
5mm, 32cm



Mayo Operating Scissors

Large, sturdy blades for incising heavy tissue.



TI-477-4044
10mm, 32cm

Detach Scissors Insert
 TI-478-4044
 Cleaning brushes, pkg/5

Detach Handle/Shaft

TI-478-4045
 Roto-Cam, monopolar,
 5mm, 32cm



Supercut Detach Scissors

Unique supercut blade has a finely-serrated lower blade that helps prevent tissue slippage, curved blades meet the contour of structures while the blunt-shaped distal tip allows tissue manipulation and cauterization with blades closed, double action.

TI-478-4046
 Roto-Cam, monopolar,
 5mm, 32cm

TI-478-4047
 Insert 5mm, 32cm

TI-478-4048
 Insert 5mm, 32cm, pkg/3

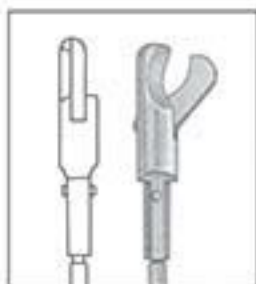

Hook Detach Scissors

Classic hook blades designed to lift, isolate and transect tissue.

TI-478-4049
 Roto-Cam, monopolar,
 5mm, 32cm

TI-478-4050
 Insert 5mm, 32cm

TI-478-4051
 Insert 5mm, 32cm, pkg/3

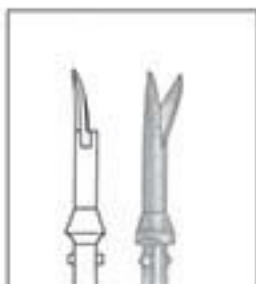

Micro Detach Scissors Curved

Delicate, sharp-sharp, curved blades.

TI-478-4052
 Roto-Cam, monopolar,
 5mm, 32cm

TI-478-4053
 Insert 5mm, 32cm

TI-478-4054
 Insert 5mm, 32cm, pkg/3





Micro Detach Scissors

Straight

Delicate, sharp-sharp, straight blades



TI-479-4055
Roto-Cam, monopolar,
5mm, 32mm

TI-479-4056
Insert, 5mm, 32mm

TI-479-4057
Insert, 5mm, 32mm, plg/3



Metzenbaum Detach Scissors

Long, curved, tapered blades with wide spread, double action



TI-479-4058
Roto-Cam, monopolar,
5mm, 32mm

TI-479-4059
Insert, 5mm, 32mm

TI-479-4060
Insert, 5mm, 32mm, plg/3



"Baby" Metzenbaum Detach Scissors

Shorter, curved, very tapered blades reach more narrow and delicate dissection areas, double action



TI-479-4061
Roto-Cam, monopolar,
5mm, 32mm

TI-479-4062
Insert, 5mm, 32mm

TI-479-4063
Insert, 5mm, 32mm, plg/3



Mini Detach Scissors

Curved, tapered, delicate blades, double action



TI-479-4064
Roto-Cam, monopolar,
5mm, 32mm

TI-479-4065
Insert, 5mm, 32mm

TI-479-4066
Insert, 5mm, 32mm, plg/3



Biopsy Forceps

Two sharp teeth, one on each jaw, for biopsy or secure hold of thick-walled tissue.

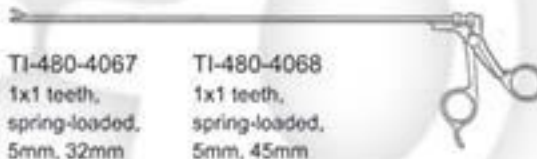

TI-480-4067
1x1 teeth,
spring-loaded,
5mm, 32mm

TI-480-4068
1x1 teeth,
spring-loaded,
5mm, 45mm



Biopsy Punches

Serrated lower jaw.

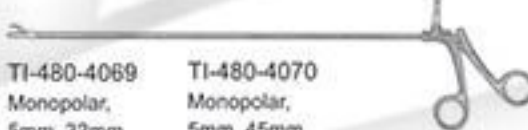

TI-480-4069
Monopolar,
5mm, 32mm

TI-480-4070
Monopolar,
5mm, 45mm



Hook Biopsy Punches

Frangenheim-type electrosurgical biopsy punch with hook blade.

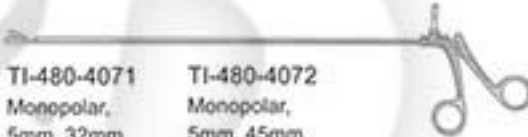

TI-480-4071
Monopolar,
5mm, 32mm

TI-480-4072
Monopolar,
5mm, 45mm



Biopsy Punches

Single tooth in upper jaw.

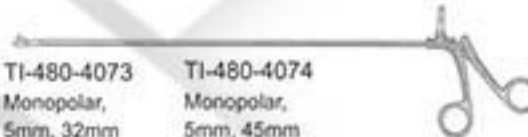

TI-480-4073
Monopolar,
5mm, 32mm

TI-480-4074
Monopolar,
5mm, 45mm



Biopsy Forceps

Oval-shaped fenestrated jaws.

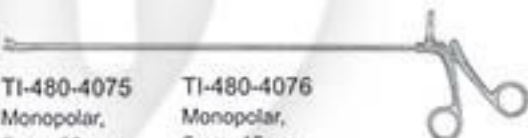

TI-480-4075
Monopolar,
5mm, 32mm

TI-480-4076
Monopolar,
5mm, 45mm



Micro Biopsy Forceps

3mm jaws for biopsy of small, delicate tissues.

TI-481-4077
Spring-loaded,
5mm, 32cm



Spoon Forceps

Wide cup-shaped jaws for tissue or stone removal.

TI-481-4078
Spring-loaded,
5mm, 32cm



Cholangiogram Clamp

Channel for placement of 5Fr or smaller cholangiogram catheter.

TI-481-4079
Ratchet,
5mm, 32cm



Cholangiogram Guide

Curved tip for simple placement of cholangiogram catheter.

TI-481-4080
5mm, 32cm



Bessler/Treat Suture Forceps

Uniquely designed jaws allow easier grasp and positioning tubular structure for placement of purse string with straight of curved needle.

TI-481-4081
5mm, 32cm



22

MICRO SURGERY INSTRUMENTS



TALC INDUSTRIES
ONE STOP FOR MEDICAL EQUIPMENT





Microsurgical Forceps

with platform, round handle, 18.0cm / 7"

- TI-482-4082 - Curved 0.4mm micro tip
- TI-482-4083 - Curved 0.5mm micro tip 1/2 teeth
- TI-482-4084 - Curved 0.8mm delicate tip
- TI-482-4085 - Curved 0.8 delicate tip 1 x 2
- TI-482-4086 - Straight 0.4mm micro tip
- TI-482-4087 - Straight 0.5mm micro tip 1 x 2 teeth
- TI-482-4088 - Straight 0.8mm delicate tip
- TI-482-4089 - Straight 0.8mm delicate tip 1 x 2 teeth

Rhoton Type Suture Tying Forceps

TI-482-4090

with platform, round handle,
18.0cm / 7" Straight

Micro Suture Tying Forceps

with platform, round handle,
15.0cm / 6"

- TI-482-4091 Curved
- TI-482-4092 Straight



TI-483-4093
serrated

TI-483-4095
serrated



TI-483-4094



TI-483-4096



TI-483-4097

TI-483-4198

Microsurgical Scissors
Wide handle, 15.0cm / 6"
regular blade

Microsurgical Scissors
Wide handle, 15.0cm / 6"
micro blade



TI-483-4099

TI-483-4100



TI-483-4101
angle to side, 60°



TI-483-4102

TI-483-4103

Microsurgical Scissors
Round handle, 18.0cm / 7"
regular blade

Microsurgical Scissors
Round handle, bayonet
shape, 21.0cm / 8 1/2"
regular blade



Microsurgical Needle Holders
round handle, 15.0cm / 6"

- TI-484-4104 Straight jaw
- TI-484-4105 Curved jaw
- TI-484-4106 Straight jaw, catch
- TI-484-4107 Curved jaw, catch



Microsurgical Needle Holders
with handle, 15.0cm / 6"

- TI-484-4108 Straight jaw
- TI-484-4109 Curved jaw



Microsurgical Needle Holders
round handle, 18.0cm / 7"

- TI-484-4110 Straight jaw, micro tip
- TI-484-4111 Straight jaw, micro tip, catch
- TI-484-4112 Straight jaw, delicate tip
- TI-484-4113 Straight jaw, delicate tip, catch
- TI-484-4114 Curved jaw, micro tip
- TI-484-4115 Curved jaw, micro tip, catch
- TI-484-4116 Curved jaw, delicate tip
- TI-484-4117 Curved jaw, delicate tip, catch

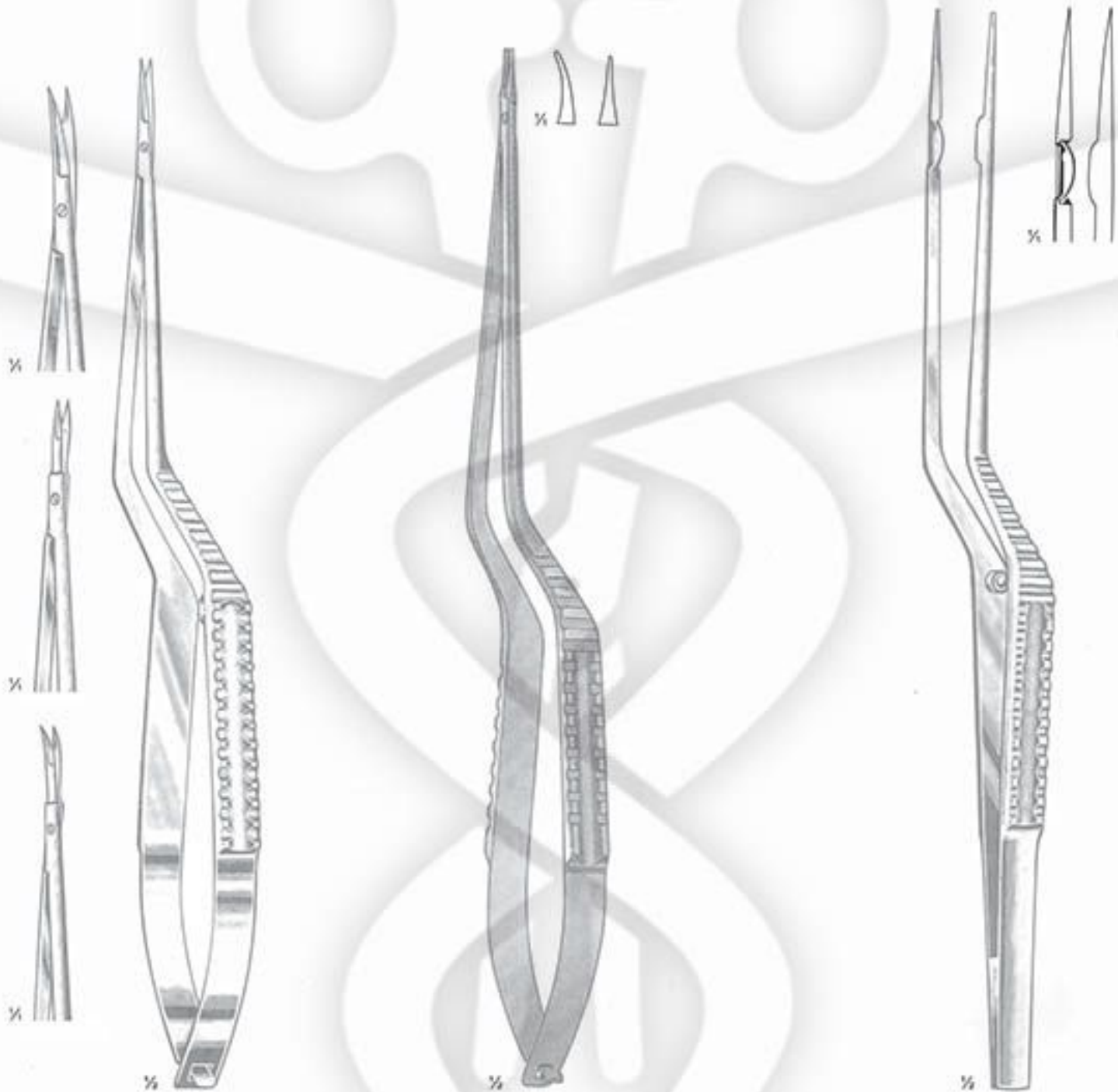

Yasargil Scissors

bayonet handle, 22.0cm / 8 1/2"

- TI-485-4118 Straight, regular blade
- TI-485-4119 Curved, regular blade
- TI-485-4120 Straight, regular blade
- TI-485-4121 Curved, regular blade

Yasargil Needle Holders

bayonet handle, 22.0cm / 8 1/2"

- TI-485-4122 Straight jaw
- TI-485-4123 Curved jaw

Yasargil Forceps

bayonet handle, 22.0cm / 8 1/2"

- TI-485-4124 Blunt tip
- TI-485-4125 Sharp tip

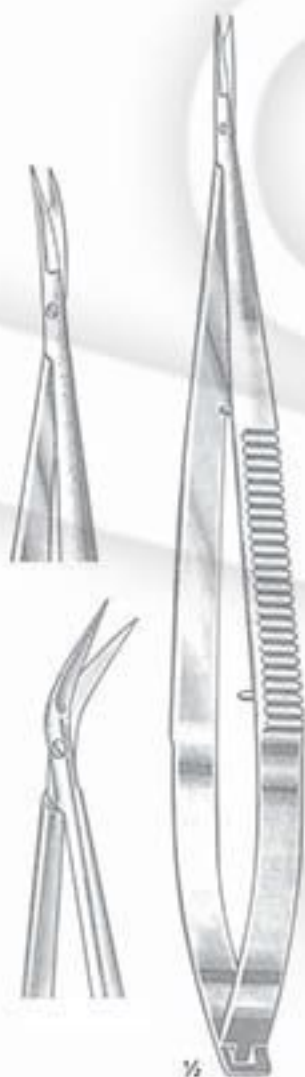

Jacobson Scissors
straight handle, 18.5cm / 7 1/4"

- TI-486-4126 Straight blade
- TI-486-4127 Curved blade
- TI-486-4128 Angled on edge



Jacobson Scissors
bayonet handle, 18.5cm / 7 1/4"

- TI-486-4129 Straight, regular blade
- TI-486-4130 Curved, regular blade
- TI-486-4131 Angled on edge, regular blade
- TI-486-4132 Straight, micro blade
- TI-486-4133 Curved, micro blade



Jacobson Needle Holders
straight handle, 18.5cm / 7"

- TI-486-4134 without catch
- TI-486-4135 with catch



Jacobson Needle Holders
straight handle, without catch
18.0cm / 7"

- TI-486-4136 Straight jaw
- TI-486-4137 Fine curved jaw



Microsurgical Needle Holders
18.0cm / 7" Carb-Bite Jaws

- TI-487-4138 Smooth
- TI-487-4139 Serrated



Microsurgical Needle Holders
21.5cm / 8 1/2" Carb-Bite Jaws

- TI-487-4140 Smooth
- TI-487-4141 Serrated



Jacobson Forceps
bayonet handle, 16.0 cm / 6 1/4"
sharp tips

- TI-487-4142



Jacobson Forceps
bayonet handle, 18.5 cm / 7 1/2"
sharp tips

- TI-487-4143 Blunt tips
- TI-487-4144 Sharp tips
- TI-487-4145 Angled blunt tips

23

OPHTHALMIC INSTRUMENTS





Eye Dressing Forceps
TI-488-4146
10.0 cm / 4", delicate,
serrated, straight,
0.7mm wide at tip

Eye Dressing Forceps
TI-488-4147
10.0 cm / 4",
serrated, straight,
0.8mm wide at tip



Eye Dressing Forceps
TI-488-4148
9.9 cm / 3 7/8", delicate,
serrated, half curved
0.7mm wide at tip

Eye Dressing Forceps
TI-488-4149
9.9 cm / 3 7/8",
serrated, half curved
0.8mm wide at tip



Eye Dressing Forceps
TI-488-4150
9.7 cm / 3 7/8", delicate,
serrated, full curved
0.7mm wide at tip

Eye Dressing Forceps
TI-488-4151
9.7 cm / 3 7/8",
serrated, full curved
0.8mm wide at tip



Iris Forceps
TI-488-4152
10.0 cm / 4", delicate,
serrated, 1x2 teeth,
0.7mm wide at tip

Iris Forceps
TI-488-4153
10.0 cm / 4",
serrated, 1x2 teeth,
0.8mm wide at tip



Iris Forceps
TI-488-4154
9.9 cm / 3 7/8", delicate,
half curved, 1x2 teeth
0.7mm wide at tip

Iris Forceps
TI-488-4155
9.9 cm / 3 7/8",
half curved, 1x2 teeth
0.8mm wide at tip



Iris Forceps
TI-488-4156
9.7 cm / 3 7/8", delicate,
full curved, 1x2 teeth
0.7mm wide at tip

Iris Forceps
TI-488-4157
9.7 cm / 3 7/8",
full curved, 1x2 teeth
0.8mm wide at tip

Von Graefe Iris Forceps

7.2 cm / 2¾", straight, 0.7mm tip

TI-489-4158 Serrated
TI-489-4159 1 x 2 teeth



Von Graefe Iris Forceps

7.2 cm / 2¾", straight, 0.7mm tip

TI-489-4160 Serrated
TI-489-4161 1 x 2 teeth



Gill Iris Forceps

7.5 cm / 3", curved, 0.5mm tip,
1 x 2 teeth

TI-489-4162



Bishop Harmon Iris Forceps

8.9 cm / 3½"

TI-489-4163 - 0.6mm, 1 x 2 teeth
TI-489-4164 - 0.4mm, 1 x 2 teeth, extra delicate
TI-489-4165 - 0.3mm, 1 x 2 teeth, micro surgery
TI-489-4166 - 0.6mm, serrated



Gill Iris Forceps

7.5 cm / 3", curved, 0.6mm tip,
1 x 2 teeth down

TI-489-4167



Gill Iris Forceps

7.5 cm / 3", curved,
cross-serrated

TI-489-4168



Botvin Iris Forceps

7.5 cm / 3", bayonet-shaped,
cross-serrated

TI-489-4169





Eiseling Fixation Forceps
10.6 cm / 4 1/8"
1 x 2 teeth
TI-490-4170



Thorpe Conjunctival Fixation Forceps
9.5 cm / 3 3/4"
2 x 3 teeth with tying platform
TI-490-4171



Von Graefe Fixation Forceps
11.4 cm / 4 1/2"
with catch, 4.5mm jaws
TI-490-4172



Von Graefe Fixation Forceps
11.4 cm / 4 1/2"
plain, 4.5mm jaws
TI-490-4173



Lester Fixation Forceps
9.7 cm / 3 3/8"
2 x 3 teeth
TI-490-4174



Lester Fixation Forceps
9.7 cm / 3 3/8"
1 x 2 teeth
TI-490-4175



Green Fixation Forceps
10.2 cm / 4"
10mm jaws with fine teeth
TI-490-4176



Bracken Fixation Forceps
10.8 cm / 4 1/4"
1 x 2 teeth
TI-490-4177



Bonn Iris Forceps
7.0 cm / 2 3/4"
0.12mm teeth
original pattern,
without tying platform
TI-491-4178

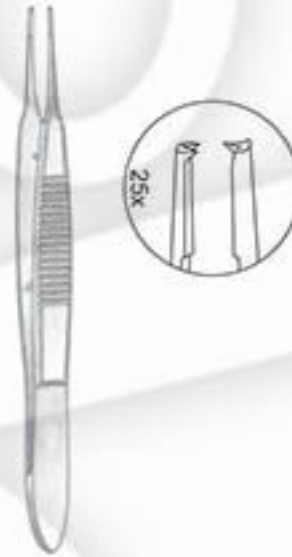

Bonn Suture Forceps
9.5 cm / 3 1/4"
0.12mm teeth
5mm tying platform
TI-491-4179



Troutman-Barraquer Utility Forceps (Colibri-Type)
7.5 cm / 2 3/4" teeth at 45° angle,
6mm tying platform

- TI-491-4180 - 0.12mm teeth
- TI-491-4181 - 0.3mm teeth
- TI-491-4182 - 0.5mm teeth

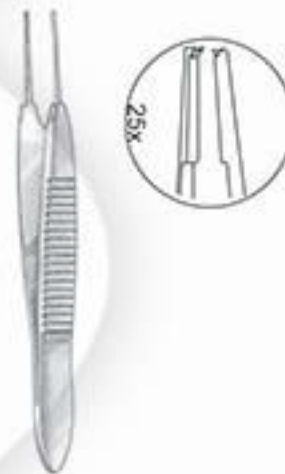

Bonn Iris Forceps
7.0 cm / 3 1/4"
0.12mm teeth
4mm tying platform
TI-491-4183



Girard Corneo-Scleral Forceps
(Colibri-Type)

10.8 cm / 4 1/4", for right hand,
round knurled handle,
0.12mm teeth, 6mm tying platform
TI-492-4184



Girard Corneo-Scleral Forceps
(Colibri-Type)

10.8 cm / 4 1/4", for left hand,
round knurled handle,
0.12mm teeth, 6mm tying platform
TI-492-4185



Castroviejo Corneo-Scleral Suture Forceps

4" (10.2cm), 6mm tying platform

TI-492-4186 - 0.5mm teeth
TI-492-4187 - 0.9mm teeth
TI-492-4188 - 1.5mm teeth



Castroviejo Colibri Forceps

10.8cm / 4 1/4", wide handle,
0.5mm teeth, 7mm tying platform
TI-492-4189



Castroviejo Suture Forceps

10.8 cm / 4 1/4", wide handle,
6mm tying platform

TI-492-4190 - 0.12mm teeth
TI-492-4191 - 0.3mm teeth
TI-492-4192 - 0.5mm teeth
TI-492-4193 - 0.9mm teeth
TI-492-4194 - 1.5mm teeth



Pierse Colibri Forceps

7.6cm / 3"

TI-492-4195 - 0.1mm teeth
TI-492-4196 - 0.3mm teeth



Castroviejo Suture Forceps

10.8 cm / 4 1/4", wide handle,
without tying platform

TI-492-4197 - 0.3mm teeth
TI-492-4198 - 0.5mm teeth



Jewelers Style Forceps
Style 1: fine
TI-493-4199



Jewelers Style Forceps
Style 3: very fine
TI-493-4200



Jewelers Style Forceps
Style 3C: very fine
TI-493-4201



Jewelers Style Forceps
Style 4: very fine
TI-493-4202



Jewelers Style Forceps
Style 5: very fine
TI-493-4203



Jewelers Style Forceps
Style 7: very fine, curved
TI-493-4204



Nugent Utility Forceps
10.8 cm / 4 1/4", 45° angled jaws
TI-494-4205 - Smooth
TI-494-4206 - Cross-serrated



Wills Hospital Utility Forceps
10.2 cm / 4", 4 cross rated
TI-494-4207



McCullough Utility Forceps
10.2 cm / 4", cross-serrated
TI-494-4208



McCullough Utility Forceps
10.2 cm / 4", cross-serrated
1 x 2 teeth
TI-494-4209



Harms Suture Tying Forceps
10.8 cm / 4 1/4", wide handle,
6.5mm tying platform
TI-494-4210 - Straight
TI-494-4211 - Curved



Harm's Suture Tying Forceps
10.2 cm / 4", regular handle,
6.2mm tying platform

TI-495-4212 - Straight
TI-495-4213 - Curved



Castroviejo Suture Tying Forceps
10.8 cm / 4¼", 5mm tying platform
TI-495-4214



Troutman-Barraquer Corneal Utility Forceps (Colibri-Type)
7.1 cm / 2¾", 0.12mm teeth
TI-495-4215



Polack Double Corneal Forceps (Colibri-Type)
7.1 cm / 2¾", 3mm long tips with 1 x 2 teeth
TI-495-4216



Bonaccolto Utility Forceps
10.8cm / 4", cross serrated

TI-495-4217 - 1.2mm wide platform
TI-495-4218 - 1.7mm wide platform



Chandler Iris Forceps
7.6 cm / 3"
TI-496-4219



Schaaf Foreign Body Forceps
8.9 cm / 3½"
TI-496-4220



Watzke Sleeve Spreading Forceps
11.4 cm / 4½", cross-action,
10mm serrated angled tips
TI-496-4221

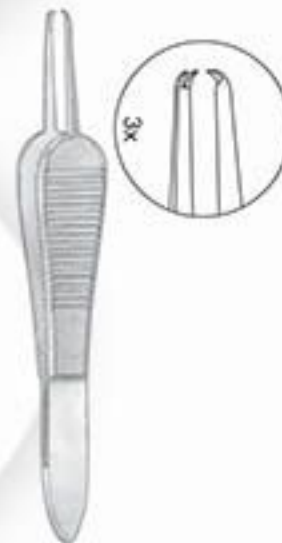

Sauer Suture Forceps
8.9 cm / 3½", 1x2 teeth
TI-496-4222



McPherson Suture Tying Forceps
8.9 cm / 3½", straight,
4.5mm tying platform
TI-497-4223



McPherson Suture Tying Forceps
8.9 cm / 3½", angled,
4.5mm tying platform
TI-497-4224



McPherson Micro Corneal Forceps
8.9 cm / 3½", straight, 1x2 teeth,
4.5mm tying platform
TI-497-4225



McPherson Micro Corneal Forceps
8.9 cm / 3½", angled,
1x2 teeth, 4.5mm tying platform
TI-497-4226



Kelman-McPherson Suture Tying Forceps
8.6 cm / 3⅜", angled,
7mm tying platform
TI-497-4227



Kelman-McPherson Micro Corneal Forceps
8.6 cm / 3⅜", angled,
1x2 teeth, 7mm tying platform
TI-497-4228



Sheets-Mcpherson Tying Forceps
8.3cm / 3¼", 45° angled jaws,
1mm cross-serrated tips,
10.5mm tying platform
TI-498-4229



Sinskey Tying Forceps
11.1cm / 4½", straight,
7mm tying platform
TI-498-4230

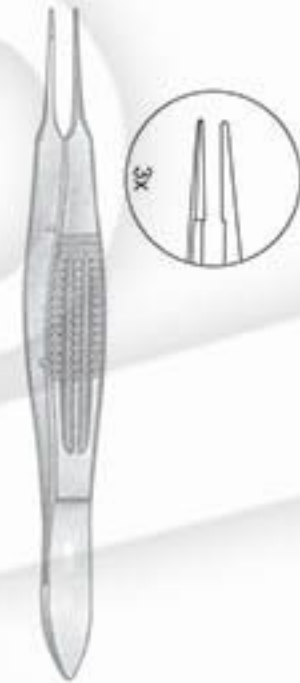

Shepard Tying Forceps
10.8cm / 4¼", straight,
wide handle, 4mm tying
platform
TI-498-4231

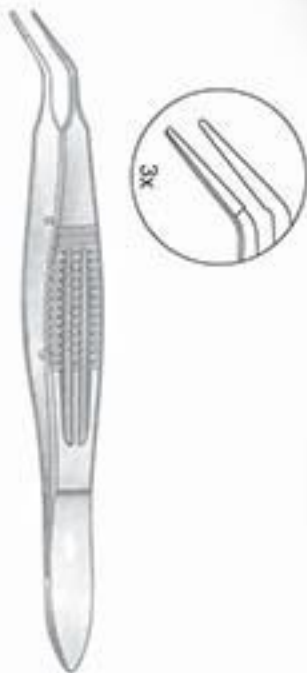

Shepard Tying Forceps
10.8cm / 4¼", 45° angle,
wide handle,
4mm tying platform
TI-498-4232



Tying Forceps
10.8cm / 4¼",
wide handle,
4mm tying platform
TI-498-4233

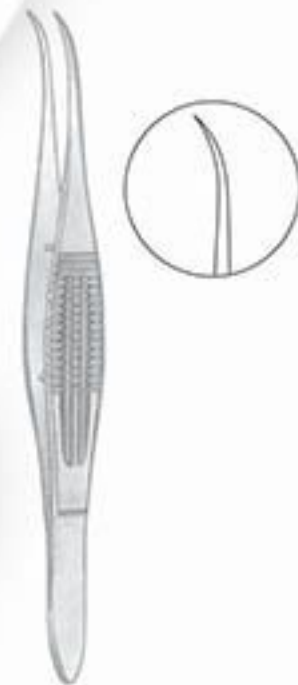

Fine Tying Forceps
10.8cm / 4¼",
wide handle,
curved tips with tying surface
TI-498-4234



Ziegler Cilia Forceps
8.6cm / 3 1/4"
TI-499-4235



Littauer Cilia Forceps
8.3cm / 3 1/4"
TI-499-4236



Douglas Cilia Forceps
8.9cm / 3 1/2"
TI-499-4237



Gradle Cilia Forceps
9.8 cm / 3 7/8"
2mm wide platform
TI-499-4238



Barraquer Cilia Forceps
10.2 cm / 4"
6mm long platform
TI-499-4239



Shepard Intraocular Lens Forceps
9.2 cm / 3 5/8", curved shafts,
slide lock,
1.5mm upper and
2mm lower serrated jaws
TI-499-4240



Clayman Lens Forceps
12.0 cm / 4 3/4", curved shafts,
3mm angled tips
TI-499-4241

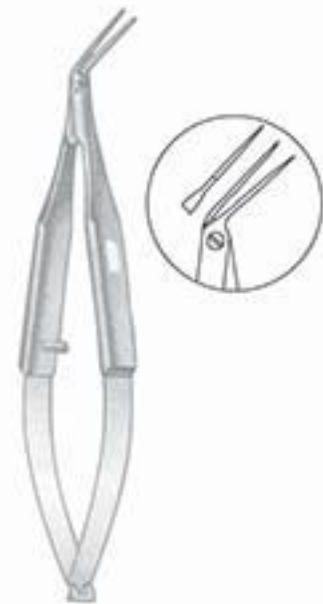

Thornton Intraocular Lens Forceps
8.6 cm / 3 3/8",
11mm angled jaws 45°
TI-499-4242



Lambert Chalazion Forceps
9.2 cm / 3 $\frac{1}{2}$ ",
8mm inside diameter
of fenestrated jaw
TI-500-4243



Heath Chalazion Forceps
9.5 cm / 3 $\frac{1}{4}$ ",
12mm x 14mm inside
diameter of fenestrated jaw
TI-500-4244



Hunt Chalazion Forceps
9.5 cm / 3 $\frac{1}{4}$ ",
12mm inside diameter
of fenestrated jaw
TI-500-4245



Desmarres Chalazion Forceps
8.9 cm / 3 $\frac{1}{2}$ "
TI-500-4246 11mm x 17mm inside
diameter of
fenestrated jaw
TI-500-4247 11.5mm x 22.5mm
inside diameter of
fenestrated jaw
TI-500-4248 16.5mm x 28mm
inside diameter of
fenestrated jaw



Lordan Chalazion Forceps
9.5 cm / 3 $\frac{1}{4}$ ",
7.5x12mm inside dimensions
of fenestrated jaw
TI-500-4249



Francis Chalazion Forceps
9.5 cm / 3 $\frac{1}{4}$ ",
12x14mm inside diameter
of fenestrated jaw
TI-500-4250



Snellen Entropium Forceps
8.9 cm / 3 $\frac{1}{2}$ ", 35MM
wide solid plate
TI-500-4251 - Left
TI-500-4252 - Right (illustrated)



Arruga Capsule Forceps
10.2 cm / 4"
TI-501-4253



Castroviejo Capsule Forceps
10.2 cm / 4", cross action
TI-501-4254



Capsule Fragment and Clot Forceps
5.6 cm / 2 1/4", 2mm platform and
microscopic cups on inner jaw surface
TI-501-4255



Beerke Ptosis Clamp
10.2 cm / 4", 20mm jaw
TI-501-4256



Jameson Muscle Recession Forceps
10.2 cm / 4"
TI-501-4257 Left, 12mm jaws, (illustrated)
TI-501-4258 Left, 7mm jaws
TI-501-4259 Right, 12mm jaws
TI-501-4260 Right, 7mm jaws



Troutman Superior Rectus Forceps
10.5 cm / 4 1/8",
45° angle, 10mm from tip to bend
TI-501-4261



Kalt Needle Holder
13.3 cm / 5 1/4", 12mm jaws, straight,
serrated thumb plate with lock
TI-502-4262



Kalt Needle Holders
13.3 cm / 5 1/4", 10mm jaws,
smooth, thumb plate with lock
TI-502-4263 Straight
TI-502-4264 Curved right
TI-502-4265 Curved left



Castroviejo Needle Holders
14.0 cm / 5 1/2", 11mm smooth jaws,
flat serrated handle with lock
TI-502-4266 Curved
TI-502-4267 Straight



Castroviejo Needle Holders
14.0 cm / 5 1/2", 10mm smooth jaws,
flat serrated handle with lock
TI-502-4268 Straight
TI-502-4269 Curved



Castroviejo Needle Holders
13.0 cm / 5", 9mm smooth jaws,
wide serrated handle
TI-502-4270 Straight without lock
TI-502-4271 Curved without lock
TI-502-4272 Straight with lock
TI-502-4273 Curved with lock



Castroviejo Needle Holders
14.0 cm / 5 1/2", 11mm carb-bite jaws,
flat serrated handle with lock
TI-502-4274 Smooth
TI-502-4275 Serrated



Barraquer Needle Holders
13.3 cm / 5¼", 9mm curved jaws,
round knurled handle

- TI-503-4276 With lock
- TI-503-4277 Without lock



Barraquer Needle Holders
10.2 cm / 4", 10mm smooth jaws,
round knurled handle

- TI-503-4278 Straight, without lock
- TI-503-4279 Straight, with lock
- TI-503-4280 Curved, without lock
- TI-503-4281 Curved, with lock



McPherson Needle Holders
10.2 cm / 4", 10mm smooth jaws,
flat serrated handle

- TI-503-4282 Straight, without lock
- TI-503-4283 Straight, with lock
- TI-503-4284 Curved, without lock
- TI-503-4285 Curved, with lock



Anis Needle Holders
13.0 cm / 5", 8mm smooth jaws,
round knurled handle without lock

- TI-503-4286 Straight
- TI-503-4287 Curved



Anis Needle Holders
13.0 cm / 5", 8mm smooth jaws,
round knurled handle with lock

- TI-503-4288 Straight
- TI-503-4289 Curved



Cohan Miniature Needle Holders
10.4 cm / 4½", 8mm
smooth curved jaws,
round knurled handle

- TI-503-4290 without lock
- TI-503-4291 with lock



Troutman Needle Holders
11.7 cm / 4½", 10mm
smooth curved jaws,
round serrated handle
without lock

- TI-503-4292

Knapp Iris Scissors

10.1 cm / 4", 25mm blades

TI-504-4293 Straight, sharp-sharp

TI-504-4294 Curved, sharp-sharp

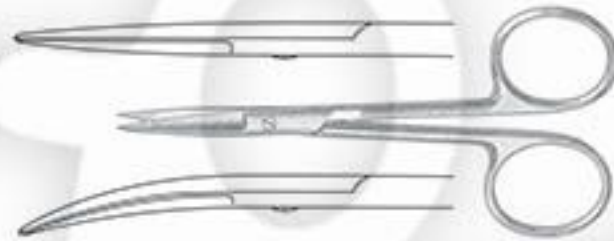

Knapp Iris Scissors

10.1 cm / 4", 25mm blades

TI-504-4295 Straight, sharp-blunt

TI-504-4296 Curved, sharp-blunt

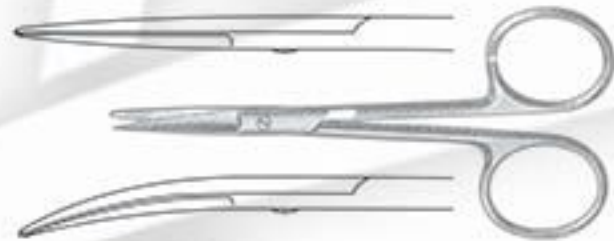

Knapp Iris Scissors

10.1 cm / 4", 25mm blades

TI-504-4297 Straight, blunt-blunt

TI-504-4298 Curved, blunt-blunt

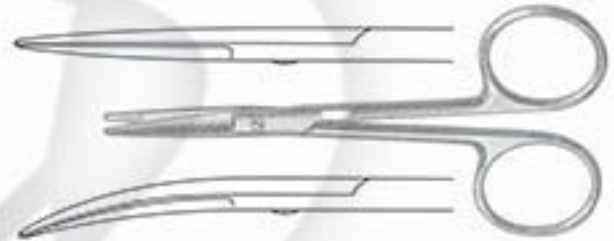

Iris Scissors

11.4 cm / 4½", 25mm blades

TI-504-4299 Straight, sharp-blunt

TI-504-4300 Curved, blunt-blunt



Iris Scissors

11.4 cm / 4½", carb-edge,
25mm blades

TI-504-4301 Straight

TI-504-4302 Curved

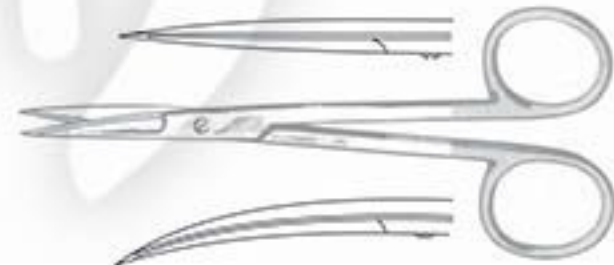

Supercut Iris Scissors
11.4 cm / 4 1/2", 25mm blades

TI-505-4303 Straight
TI-505-4304 Curved



Iris Scissors
11.4 cm / 4 1/2", angled over edge,
25mm blades
TI-505-4305

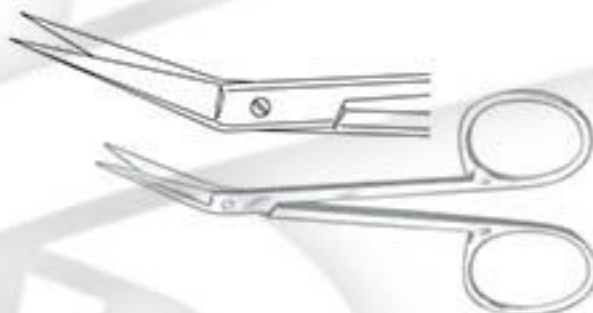

Iris Scissors
11.4 cm / 4 1/2", angled over edge,
25mm blades, probe points
TI-505-4306



Iris Scissors
22mm blades

TI-505-4307 8.9 / 3 1/2", straight
TI-505-4308 8.9 / 3 1/2", curved
TI-505-4309 10.5 / 4 1/8", delicate, straight
TI-505-4310 10.5 / 4 1/8", delicate, curved

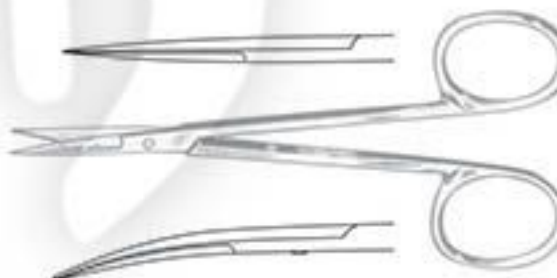

Wilmer Conjunctival Scissors
10.5cm, 4/8", delicate, 15mm blades
angled on flat
TI-506-4311



Iris Scissors
10.2cm, 4", 24mm blades
large finger rings

TI-506-4312 Straight
TI-506-4313 Curved



Iris Scissors
10.5cm, 4/8", delicate, 27mm blades

TI-506-4314 Straight
TI-506-4315 Curved

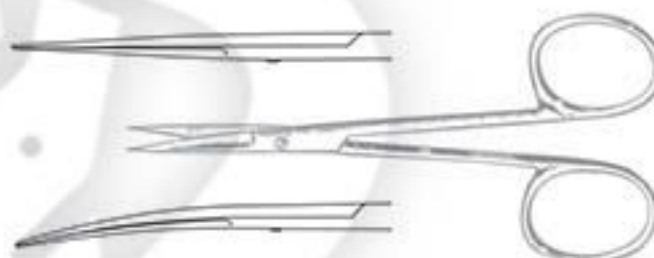

Iris Scissors
10.2cm, 4", 22mm blades,
flat shanks

TI-506-4316 Straight
TI-506-4317 Curved

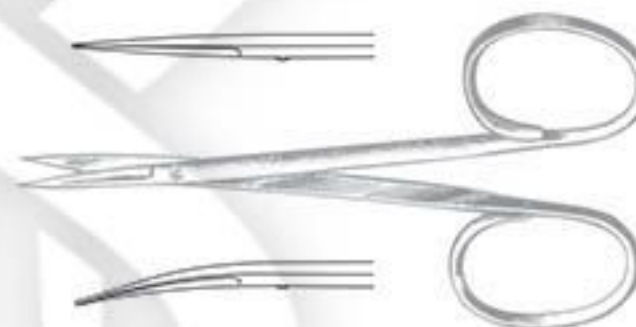

Iris Scissors
8.9cm, 3/8", delicate, 12mm blades,
flat shanks

TI-506-4318 Straight
TI-506-4319 Curved



Utility Scissors

10.5cm, 4 $\frac{1}{2}$ ", 15mm blades,
flat shanks

TI-507-4320 Straight

TI-507-4321 Curved

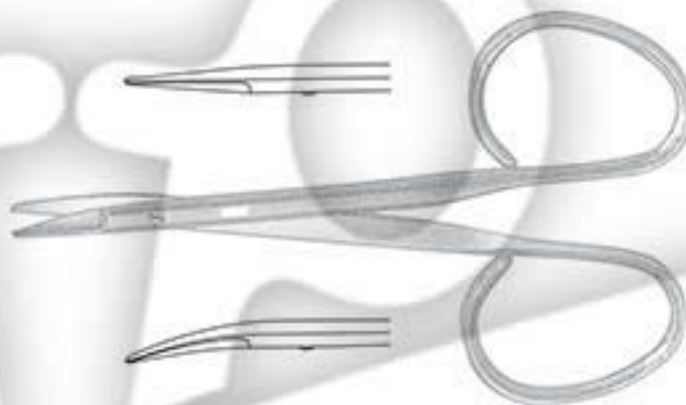

Strabismus Scissors

11.4cm, 4 $\frac{1}{2}$ ", 30mm blades

TI-507-4322 Straight

TI-507-4323 Curved



Strabismus Scissors

11.4cm, 4 $\frac{1}{2}$ ", 30mm blades Carb-edge

TI-507-4324 Straight

TI-507-4325 Curved



Strabismus Scissors

10.5cm, 4 $\frac{1}{2}$ ", 25mm blades
flat shanks

TI-507-4326 Straight

TI-507-4327 Curved

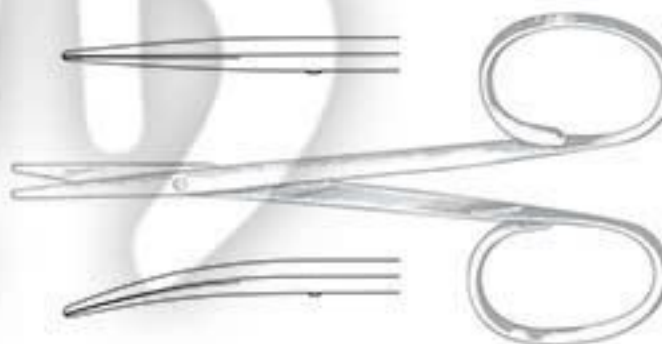

Stevens Tenotomy Scissors, blunt tips

- TI-508-4328 11.4cm / 4½", straight, slender pattern, 13mm blades
- TI-508-4329 11.4cm / 4½", curved, slender pattern, 13mm blades
- TI-508-4330 10.5cm / 4¼", straight, standard pattern, 12mm blades
- TI-508-4331 10.5cm / 4¼", curved, standard pattern, 12mm blades

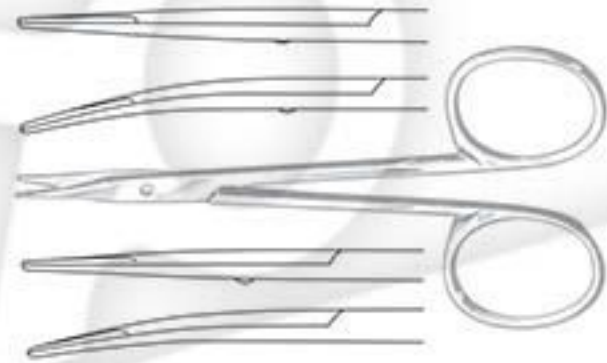

Stevens Tenotomy Scissors

9.5cm / 3¾", 13mm blades,
blunt tips, flat shanks

- TI-508-4332 Straight
- TI-508-4333 Curved



Westcott Utility Scissors

13.0cm / 5¼", 23mm blades,
curved round sharp tips
TI-508-4334



Westcott Tenotomy Scissors

11.4cm / 4½", 18mm blades,
round blunt tips
TI-508-4335 Right, curved
TI-508-4336 Left, curved
TI-508-4337 Straight

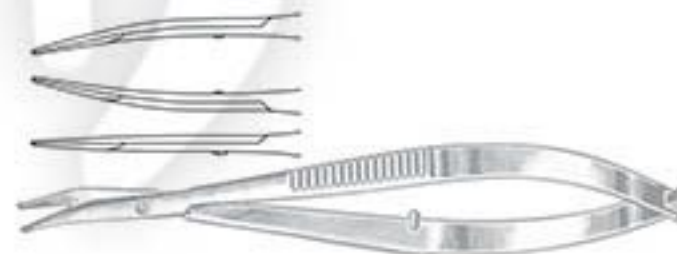



Stevens Stitch Scissors
10.5cm / 4 $\frac{1}{8}$ ", 14mm blades,
curved, sharp tips
TI-509-4338



Stevens Stitch Scissors
9.5cm / 3 $\frac{7}{8}$ ", 12mm blades,
curved sharp tips, flat shanks
TI-509-4339



Westcott Stitch Scissors
11.5cm / 4 $\frac{1}{2}$ ", 18mm blades,
curved, fine sharp tips
TI-509-4340



Stitch Scissors
12.4cm / 4 $\frac{9}{16}$ ", 13mm blades,
curved, fine sharp tips, flat shanks
TI-509-4341

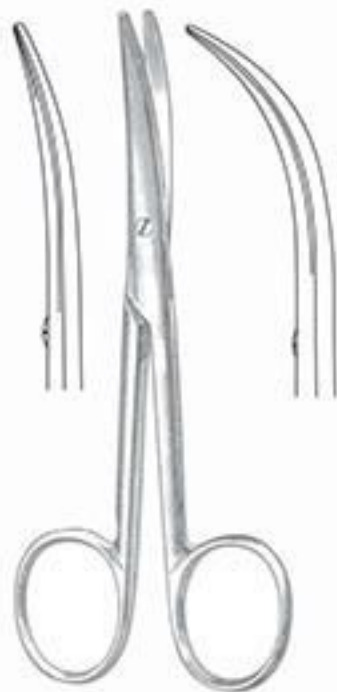

Enucleation Scissors
13.0cm / 5 $\frac{1}{8}$ ", 32mm blades,
strong curve
TI-509-4342
Enucleator Scissors
13.0cm / 5", 27mm blades,
light curve
TI-509-4343



Stitch Scissors
9.8cm / 3 $\frac{7}{8}$ ", 15mm blades,
semi-sharp tips
TI-509-4344 Straight
TI-509-4345 Curved



Gradle Stitch Scissors
9.5cm / 3 $\frac{7}{8}$ ", 13mm blades,
blunt tips
TI-509-4346



O'Brien Suture Scissors
9.5cm / 3 $\frac{7}{8}$ ", 15mm blades,
blunt tips
TI-509-4347



Micro Stitch Scissors
10.2cm / 4" 7mm blades,
fine sharp tips

TI-510-4348 Straight
TI-510-4349 Curved



Micro Stitch Scissors
11.4cm / 4½" 16mm blades,
sharp tips

TI-510-4350 Straight
TI-510-4351 Curved



McClure Iris Scissors
11.4cm / 4½" 14mm blades,
angled on flat
TI-510-4352



Castroviejo Corneal Scissors
10.8cm / 4¼" 12mm blades,
curved, blunt tips
TI-510-4353



Castroviejo Iris Scissors
9.5cm / 3¾" 11mm blades,
curved, sharp tips
TI-510-4354



Castroviejo Corneal Scissors
10.8cm / 4¼" 12mm blades,
angled, blunt tips
TI-510-4355



Castroviejo Corneal Section Scissors
10.8cm / 4¼" curved, blunt tips

TI-510-4356 Right, standard, 13mm blades
TI-510-4357 Left, standard, 13mm blades
TI-510-4358 Right, miniature 11mm blades
TI-510-4359 Left, miniature 11mm blades

Castroviejo Corneal Section Scissors

10.2cm / 4" microsurgery 7mm blades,
curved, blunt tips

TI-511-4360 Right

TI-511-4361 Left



Castroviejo Corneal Section Scissors

10.5cm / 4 1/8" miniature 7mm blades,
curved, blunt tips

TI-511-4362 Left

TI-511-4363 Right



Troutman-Castroviejo Corneal Section Scissors

10.5cm / 4 1/8" miniature 7mm blades,
curved, blunt tips

TI-511-4364 Left

TI-511-4365 Right



Vannas Capsulotomy Scissors

8.2cm / 3 1/8" sharp tips

TI-511-4366 Straight, 5mm blades

TI-511-4367 Curved, 5mm blades

TI-511-4368 Angled to side, 6mm blades

TI-511-4369 Angled on flat, 6mm blades



Katzin Corneal Transplant Scissors

10.8cm / 4 $\frac{1}{4}$ ", miniature 8mm blades,
curved, blunt tips.

TI-512-4370 Left
TI-512-4371 Right



Mcpherson-Vannas Iris Scissors

8.2cm / 3 $\frac{1}{4}$ ", 5mm blades,
curved, sharp tips

TI-512-4372



Gills-Welsh Vannas Scissors

angled, sharp tips

TI-512-4373 7.9cm / 3 $\frac{1}{8}$ ", microsurgery 5mm blades
TI-512-4374 8.6cm / 3 $\frac{3}{8}$ ", microsurgery 11mm blades



Barraquer-Dewecker Iris Scissors

5.7cm / 2 $\frac{1}{4}$ ", 7mm blades,
angled on flat, blunt tips

TI-512-4375

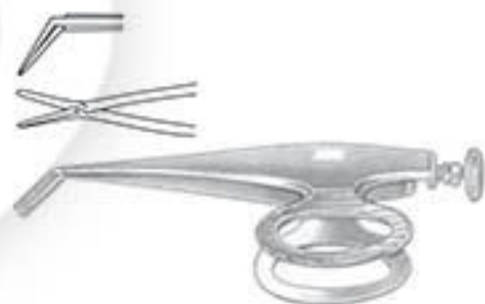

Castroviejo Caliper

8.2cm / 3¼", straight, measures from 0mm to 20mm in 1mm increments

TI-513-4376



Castroviejo Marking Caliper

8.6cm / 3⅝", curved, measures from 0mm to 20mm in 1mm increments with grooves for marking fluid

TI-513-4377



Thorpe Caliper

12.1cm / 4¾", measures from 0mm to 80mm in 1mm increments with 0 to 3 inches in ¼" increments

TI-513-4378



Jameson Caliper

8.6cm / 3⅝", measures from 0mm to 80mm in 1mm increments and 0 to 3 inches in ¼" increments

TI-513-4379



Steel Rule
graduated, 15.0cm / 6"
TI-514-4380



Steel Rule
graduated, 30.0cm / 12"
TI-514-4381



Bowman Lacrimal Probes
12.4cm / 4 7/8", double-ended, silver

- TI-514-4382 Sizes 0000-000
- TI-514-4383 Sizes 00-0
- TI-514-4384 Sizes 1-2
- TI-514-4385 Sizes 3-4
- TI-514-4386 Sizes 5-6
- TI-514-4387 Sizes 7-8



Williams Lacrimal Probes
12.4cm / 4 7/8", double-ended, silver

- TI-514-4388 Sizes 0000-000
- TI-514-4389 Sizes 00-0
- TI-514-4390 Sizes 1-2
- TI-514-4391 Sizes 3-4
- TI-514-4392 Sizes 5-6
- TI-514-4393 Sizes 7-8



24

PLASTIC SURGERY INSTRUMENTS



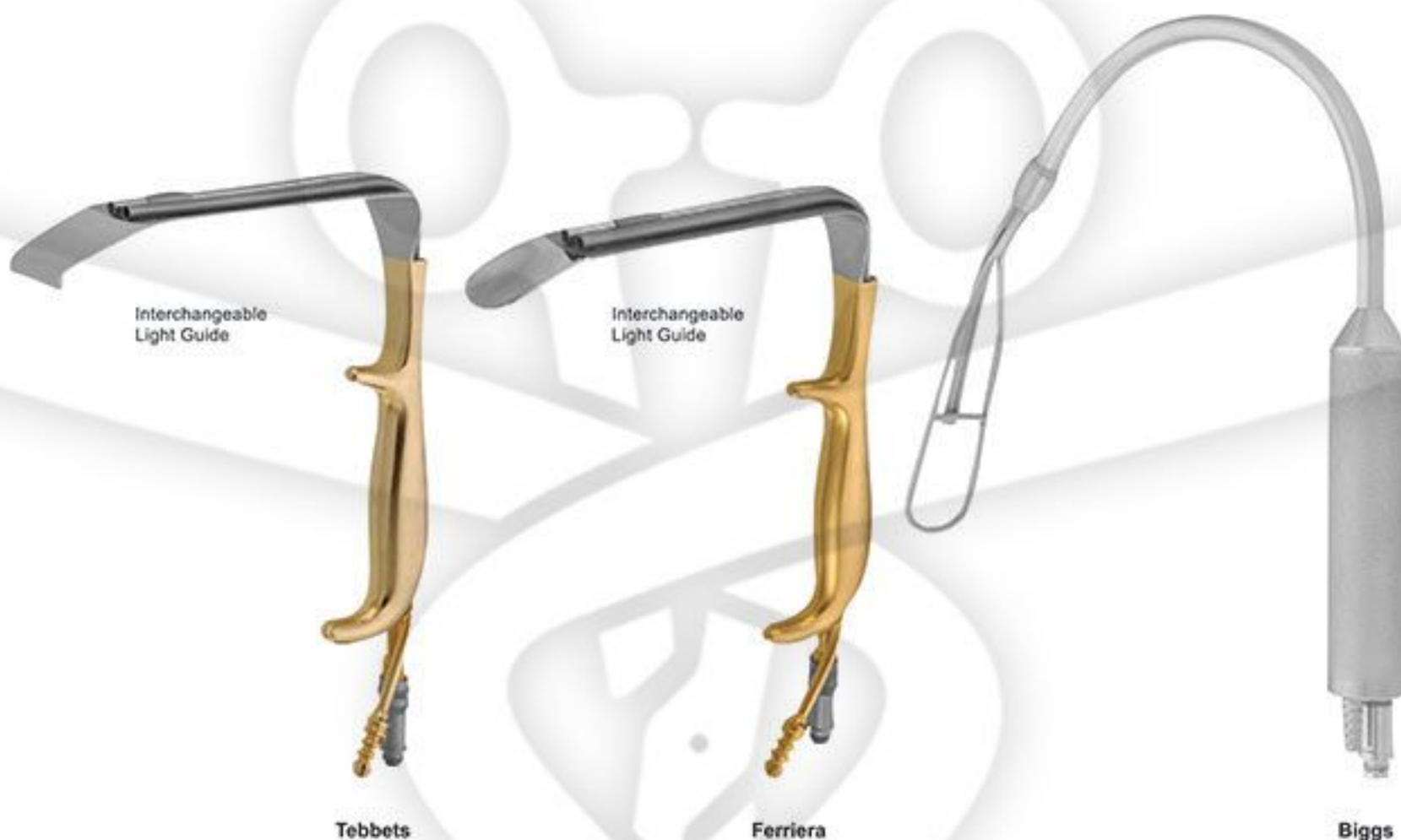

Tebbets Style Retractors

with serrated tip

With Light Guide	With Light Guide & Suction	Blades
TI-515-4394	TI-515-4405	16mm x 8cm
TI-515-4395	TI-515-4406	24mm x 9cm
TI-515-4396	TI-515-4407	24mm x 10cm
TI-515-4397	TI-515-4408	25mm x 10cm
TI-515-4398	TI-515-4409	25mm x 12cm
TI-515-4399	TI-515-4410	23mm x 15cm
TI-515-4400	TI-515-4411	30mm x 9cm
TI-515-4401	TI-515-4412	30mm x 12cm
TI-515-4402	TI-515-4413	30mm x 15cm
TI-515-4403	TI-515-4414	36mm x 16cm
TI-515-4404	TI-515-4415	36mm x 19cm

Ferriera Style Retractors

with smooth tip

With Light Guide	With Light Guide & Suction	Blades
TI-515-4416	TI-515-4429	14mm x 7cm
TI-515-4417	TI-515-4430	14mm x 9cm
TI-515-4418	TI-515-4431	16mm x 8cm
TI-515-4419	TI-515-4432	16mm x 15cm
TI-515-4420	TI-515-4433	23mm x 10cm
TI-515-4421	TI-515-4434	23mm x 15cm
TI-515-4422	TI-515-4435	23mm x 18cm
TI-515-4423	TI-515-4436	25mm x 10cm
TI-515-4424	TI-515-4437	25mm x 12cm
TI-515-4425	TI-515-4438	25mm x 15cm
TI-515-4426	TI-515-4439	25mm x 19cm
TI-515-4427	TI-515-4440	30mm x 12cm
TI-515-4428	TI-515-4441	30mm x 15cm

Biggs Mammoplasty Retractors

Retractor Only	With Light Guide	With Light Guide & Suction	Blades Width
TI-515-4442	TI-515-4444	TI-515-4446	30mm Narrow
TI-515-4443	TI-515-4445	TI-515-4447	50mm Wide



Face-lift

With Endoscopic Channel & Stopcock
to hold 10mm telescopes.

TI-516-4448 25mm x 18cm

Face-Lift Retractor

Retractor Only	With Light Guide	Blades
TI-516-4450	TI-516-4451	22mm x 11cm

Muti Approach Retractor
with smooth round tip

TI-516-4449 23mm x 18cm

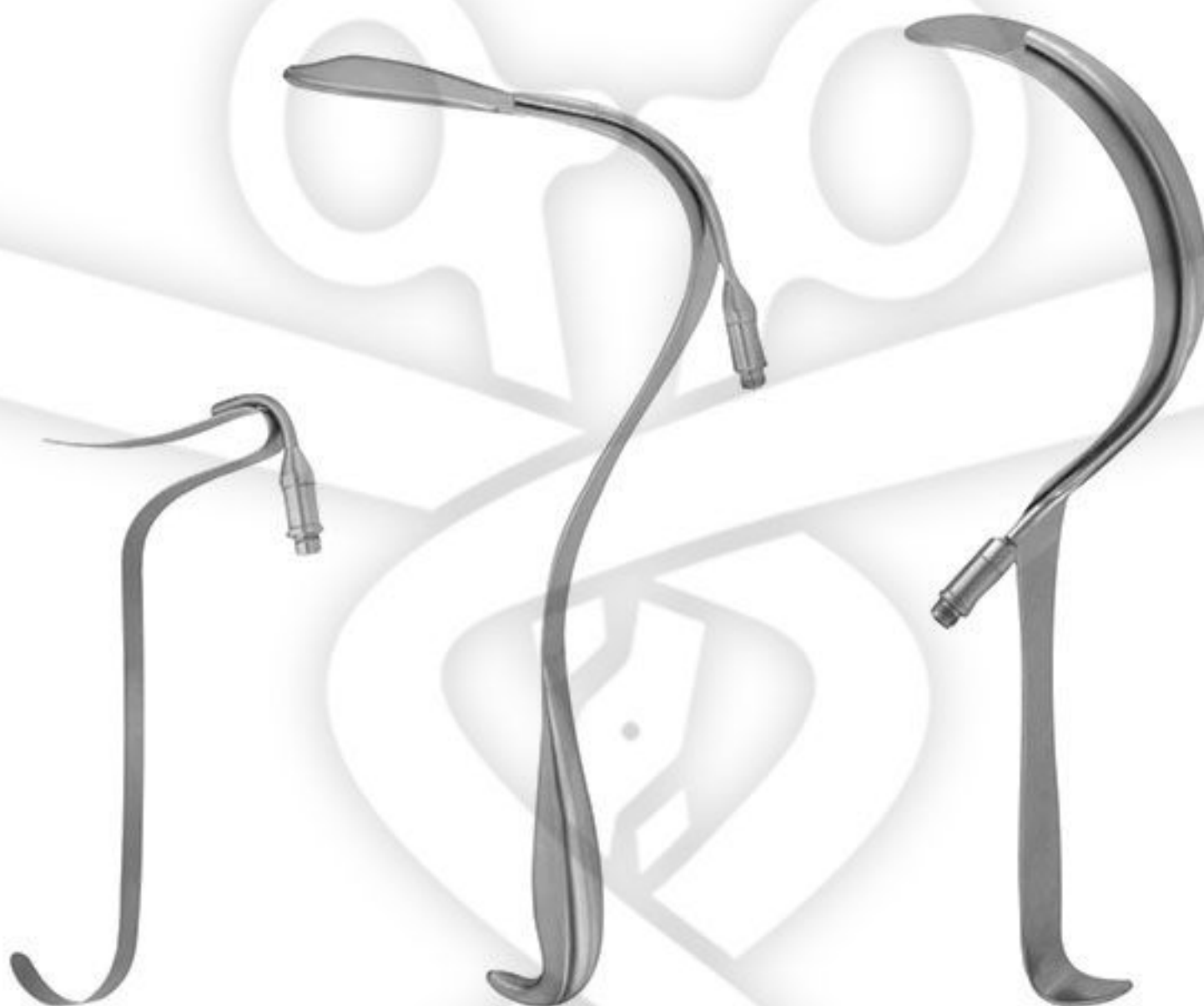

Freeman

Harrington

Deaver

FREEMAN Flap Retractors

Retractor Only	With Light Guide	Blades	Length
TI-517-4452	TI-517-4455	13mm	7" 18cm
TI-517-4453	TI-517-4456	12mm	8" 20cm
TI-517-4454	TI-517-4457	25mm	8" 20cm

HARRINGTON Retractors

12½" (32cm)

Retractor Only	With Light Guide	With Light Guide & Suction	Blades
TI-517-4458	TI-517-4460	TI-517-4462	40 x 127mm
TI-517-4459	TI-517-4461	TI-517-4463	60 x 127mm

DEAVER Retractors

Retractor Only	With Light Guide	Blades	Length
TI-517-4464	TI-517-4473	3/4" 19mm	7" 18cm
	TI-517-4474	1/2" 13mm	8" 20cm
TI-517-4465	TI-517-4475	7/8" 22mm	8" 20cm
	TI-517-4476	1" 25mm	8" 20cm
TI-517-4466	TI-517-4477	1" 25mm	9" 23cm
TI-517-4467	TI-517-4478	1" 25mm	12" 30cm
TI-517-4468		1" 25mm	13" 33cm
TI-517-4469		1" 25mm	14" 35cm
TI-517-4470	TI-517-4479	1½" 38mm	12" 30cm
TI-517-4471		2" 50mm	12" 30cm
TI-517-4472	TI-517-4480	3" 75mm	12" 30cm

Interchangeable
Light Guide



Maliniac



Converse



Aufricht



Wieder

MALINIAC Nasal Retractor

Length 4" (10cm)

With Light Guide

TI-518-4481

Blades

9mm x 45mm

AUFRICHT Nasal Retractor

Retractor Only

TI-518-4490

TI-518-4491

With Light Guide

TI-518-4492

TI-518-4493

Blades

6 3/4" (18cm) 7 mm

7" (18cm) 10mm

CONVERSE Nasal Retractor

Length 3 1/2" (9cm)

Retractor Only

TI-518-4482

TI-518-4483

TI-518-4484

TI-518-4485

With Light Guide

TI-518-4486

TI-518-4487

TI-518-4488

TI-518-4489

Blades

10 x 20mm

12 x 30mm

12 x 40mm

12 x 50mm

WIEDER Tongue Depressors

With Light Guide

TI-518-4481

TI-518-4481

With Light Guide & Suction

TI-518-4494

TI-518-4495

Blades

38mm Small

45mm Large

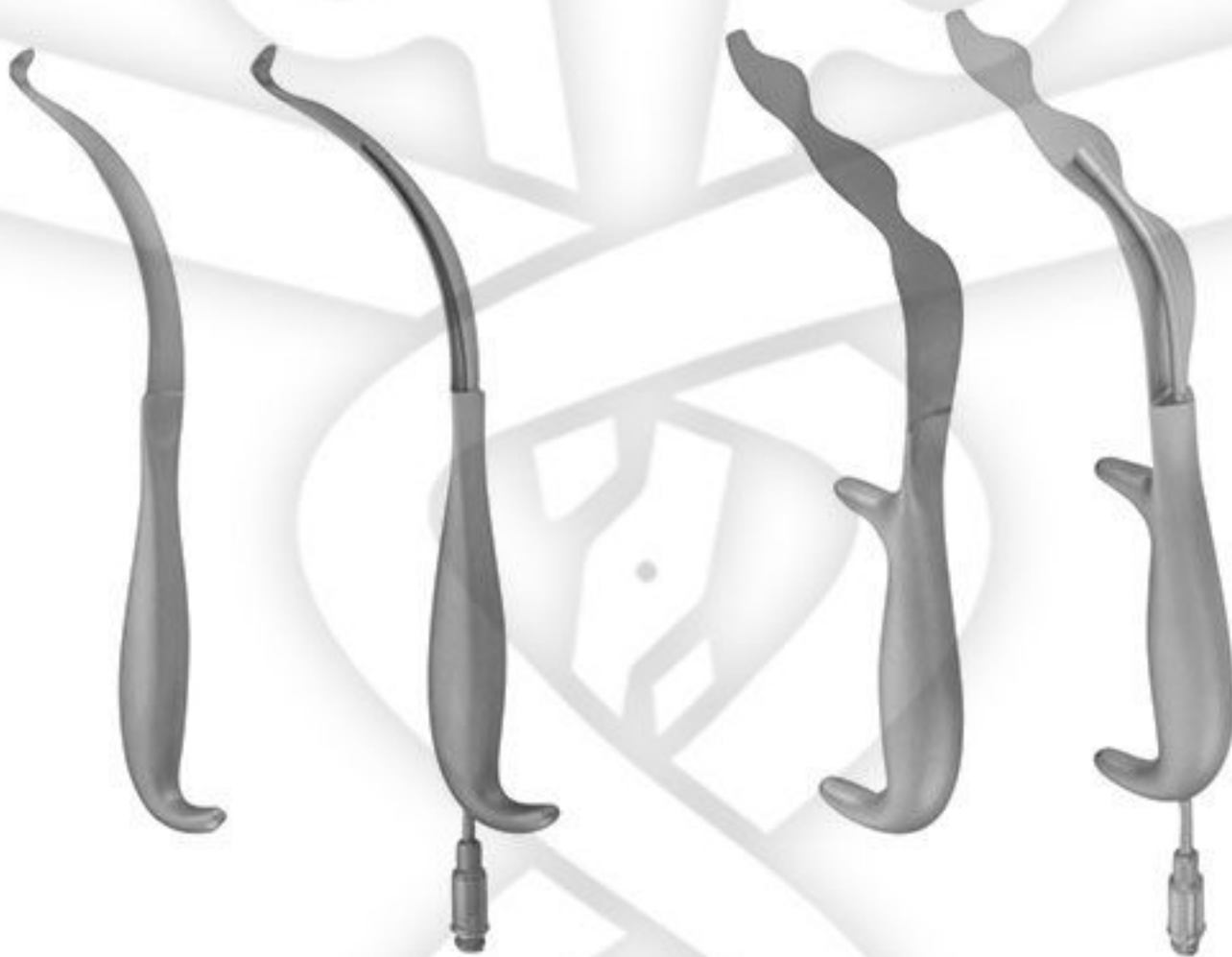

SIGMOID NOTCH
Extra Oral Retractors
Length 8 3/4" (22cm)

Retractor Only	With Light Guide	Working Tip
TI-519-4496	TI-519-4497	9.5 / 16mm

PETRI PTERYGOID
Intra Oral Retractors
Length 9" (23cm)

Retractor Only	With Light Guide	Working Tip
TI-519-4498	TI-519-4499	25.5mm

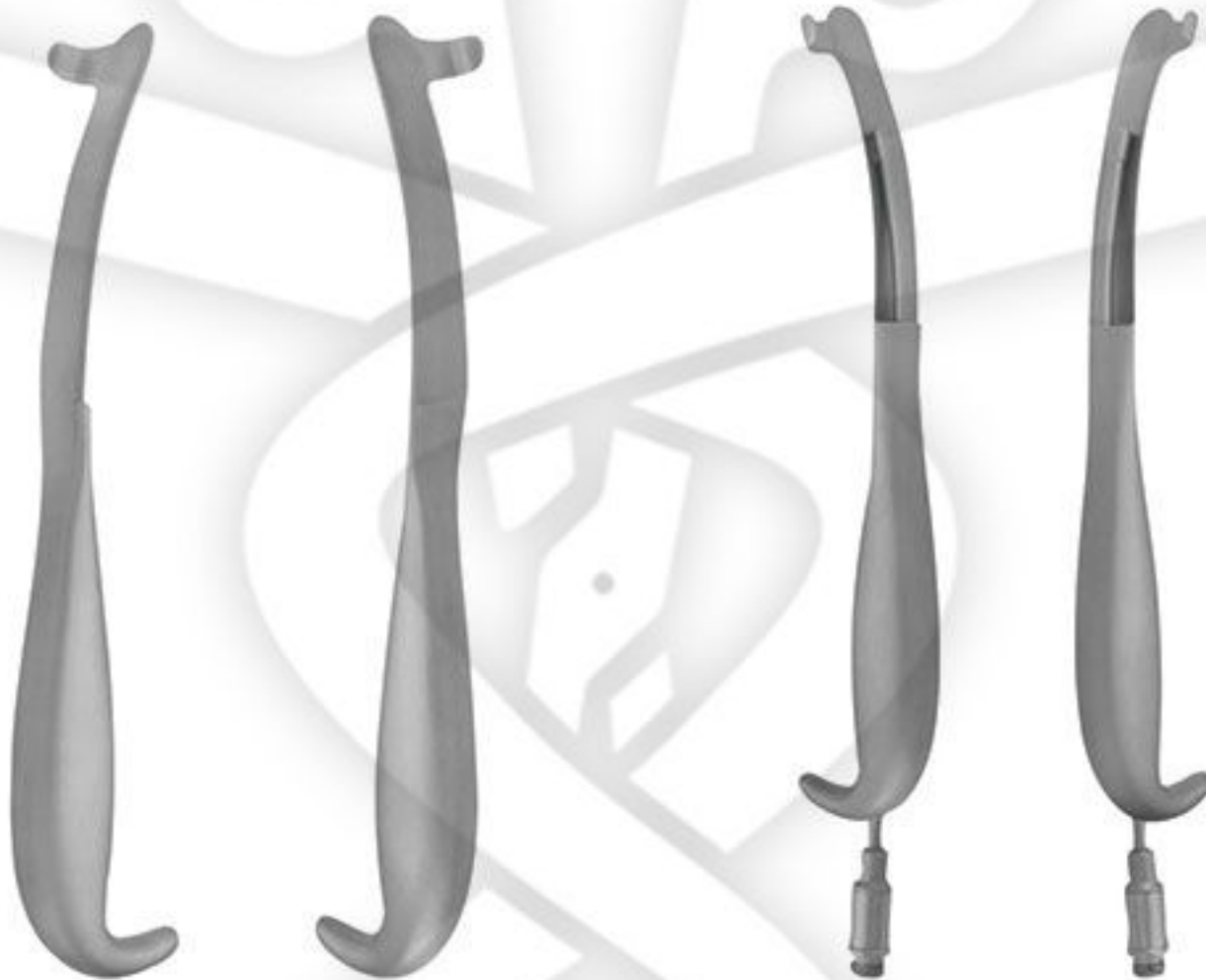

BAUER
Intra Oral Retractors
Length 8 3/4" (21cm)

Retractor Only	With Light Guide	Working Tip
TI-520-4500	TI-520-4502	26.5cm / 16mm
TI-520-4501	TI-520-4503	26.5cm / 16mm



LEVASSEUR MERRILL
Retractors for Vertical Osteotomies
Length 9 $\frac{3}{4}$ "(25cm)

Retractor Only	With Light Guide	Working Tip
TI-521-4504	TI-521-4505	12.5cm / 27mm

SHEA
Multipurpose Retractors
Length 9 $\frac{3}{4}$ "(25cm)

With Light Guide	Working Tip
TI-521-4506	14.5 mm



Breast Spatula

Breast Spatula
With handle
Length 12½" (31.5 cm)

Working Tip

TI-522-4507	25 mm x 15.5 cm
TI-522-4508	38 mm x 15.5 cm



Breast Retractor

Breast Retractor
Double-ended
Length 12½" (31.5 cm)

Working Tip

TI-522-4509	22 mm x 55 mm
TI-522-4510	38 mm x 70 mm

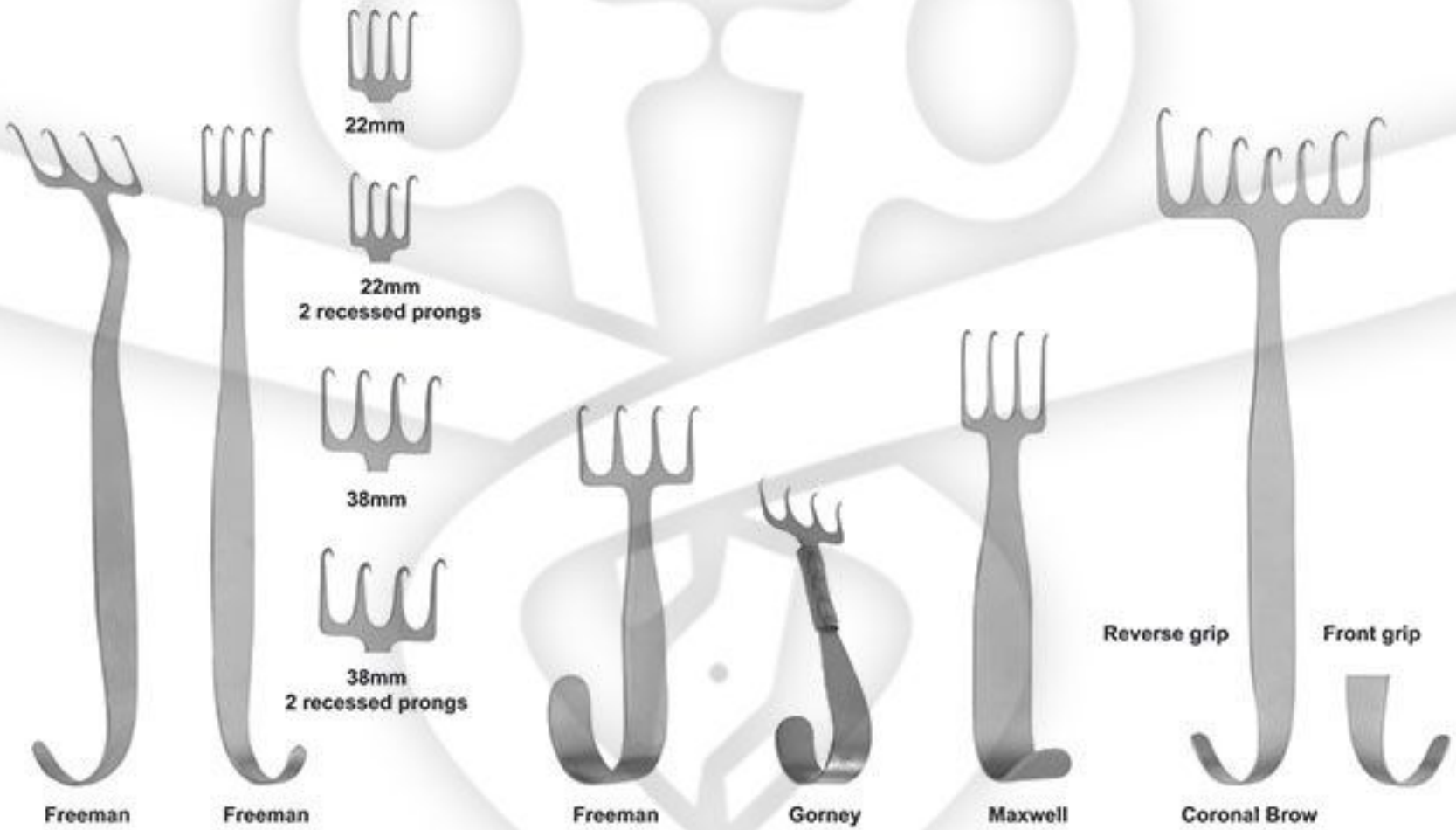

FREEMAN Free-Lift Retractor
with bent neck
Length 7" (18cm)

	Blade
TI-523-4511	38mm

FREEMAN Rake Retractor
Length 7" (18cm)

	Blade	Prongs
TI-523-4512	22mm	4
TI-523-4513	22mm	4 (2 recessed)
TI-523-4514	38mm	4
TI-523-4515	38mm	4 (2 recessed)

FREEMAN Rake Retractor
Length 4" (10cm)

	Blade
TI-523-4516	22mm
TI-523-4517	38mm

GORNEY Rake Retractor
with spring neck
Length 3" (7.5cm)

	Blade
TI-523-4518	38mm

MAXWELL Flap Retractor
Length 4" (10cm)

	Blade
TI-523-4519	22mm
TI-523-4520	38mm

Coronal Brow Lift Retractor
Length 7" (18cm), 7 prongs

	Blade	Grip hook
TI-523-4521	70mm	front
TI-523-4522	70mm	reverse



Coronal Lift

Coronal Lift Retractor
Length 8 ¼" (21cm), 6 prongs

	Blade Width
TI-524-4523	6" 15cm



Yancoskie

YANCOSKIE Abdominoplasty Retractor
Length 7 ½" (19cm), 6 prongs

	Blade Width
TI-524-4524	6" 15cm

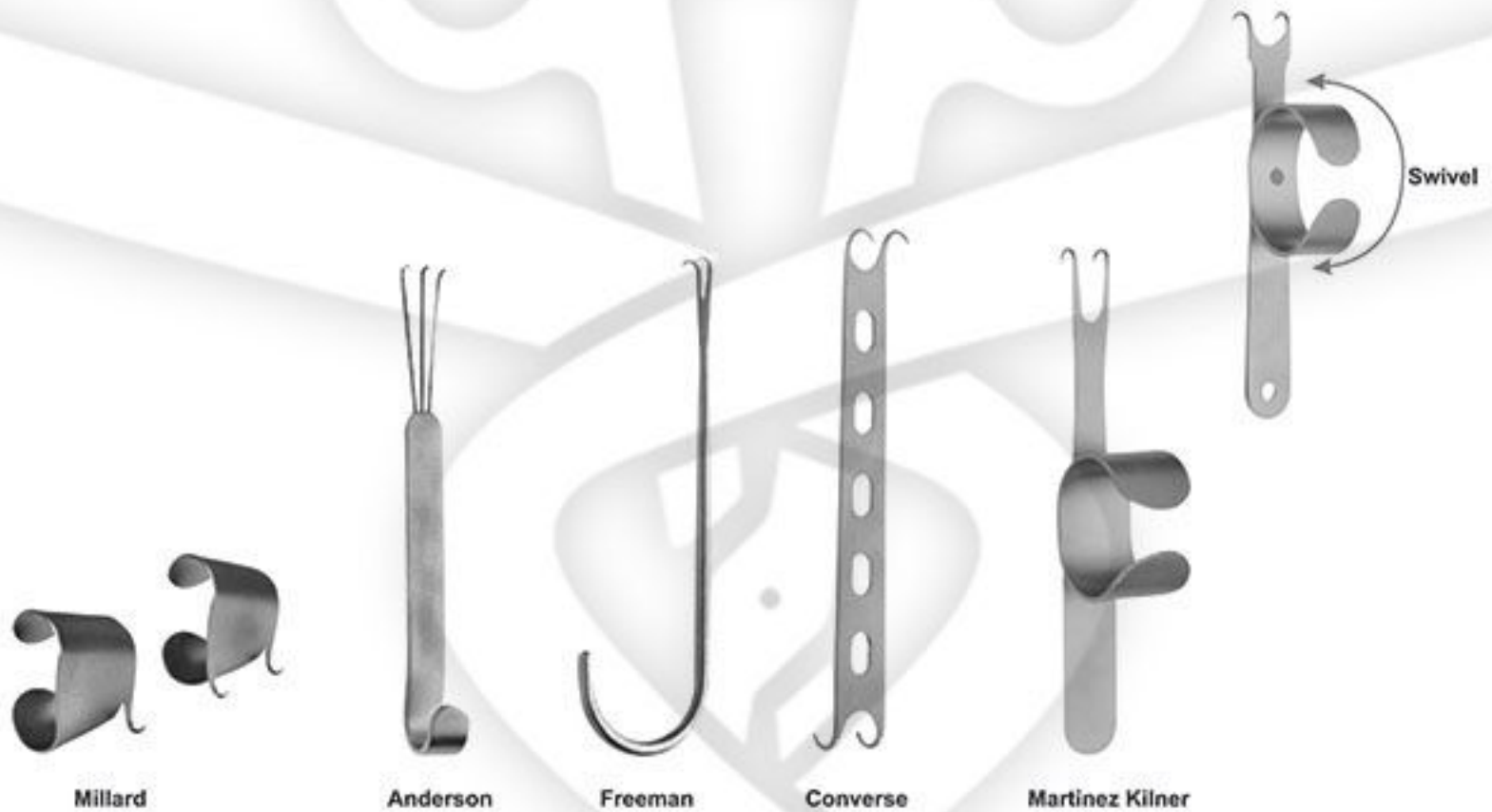

MILLARD Thimble Hooks

	Blades	Hook
TI-525-4525	18mm	Single hook
TI-525-4526	18mm	Double hook

CONVERSE Alar Retractor

double ended
Length 4 3/4" 12cm

	Blade
TI-525-4532	10mm / 14mm blunt

ANDERSON Bear Claw Retractors

TI-525-4527	TI-525-4529	2 3/4" 7cm	3 sharp prongs
TI-525-4528	TI-525-4530	4 1/2" 11cm	5 sharp prongs

MARTINEZ KILNER Retractor

2 sharp hooks, with thimble

	Length	Blades
TI-525-4533	3 1/4" 8cm	10mm (Swivel)
TI-525-4534	4 1/2" 11.5cm	7.5mm

FREEMAN

double skin hook, sharp

	Length
TI-525-4531	4" 10cm



Clodius



Wise



Sheen



Sheen



Bernstein

CLODIUS Orbital Retractor
double ended

	Blade
TI-526-4535	13mm / 20mm

WISE Orbital Retractor
double ended

	Length
TI-526-4536	6½" 16.5cm

SHEEN Nasal Retractor

	Length
TI-526-4537	6½" 16cm

SHEEN Retractor

	Length
TI-526-4538	6" 15cm

BERNSTEIN Retractor
double ended

	Length
TI-526-4539	8 x 46mm



Caroline



Cronin



Cronin



Fischl

CAROLIN Finger Retractor
double ended

Length
TI-527-4540 4 1/4" 11cm

CRONIN Lip & Nostril Retractor
double ended

Length
TI-527-4541 6 1/4" 15.5cm

CRONIN Cheek Retractor
double ended

Length
TI-527-4542 6 1/2" 16.5cm

FISCHL Shoe Horn Retractor
double ended

Length
TI-527-4543 6 1/4" 16cm



Spatulated Dissector

Agris-Dingman

**McCollum-Dingman
(Submammary Dissector)**

McCollum-Dingman

Reynolds

Spatulated Dissector

	Length
TI-528-4544	13" 33cm

AGRIS- DINGMAN Breast Dissector
graduated, length 14 1/2" 36cm

TI-528-4545	Pair
TI-528-4546	Left
TI-528-4547	Right

McCOLLUM-DINGMAN Submammary Dissector

	Length
TI-528-4548	12" 30cm

McCOLLUM-DINGMAN Breast Dissector

	Length
TI-528-4549	16 1/2" 41cm

Reynolds Transauxillary Breast Dissector
fenestrated

	Length
TI-528-4550	13" 33cm
TI-528-4551	16" 40cm

Angulated Blades



Malleable

Spatulated Blades

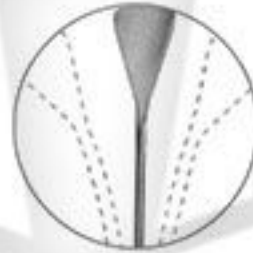

Malleable

Oval Spatulated Blades



Blunt Blade



Breast Dissector Angulated blades

	Length		
TI-529-4552	13"	33cm	Rigid
TI-529-4553	16½"	42cm	Rigid
TI-529-4554	13"	33cm	Malleable
TI-529-4555	16½"	42cm	Malleable

Breast Dissector Oval spatulated blades

	Length		
TI-529-4560	13"	33cm	Rigid
TI-529-4561	16½"	42cm	Rigid
TI-529-4562	13"	33cm	Malleable
TI-529-4563	16½"	42cm	Malleable

Breast Dissector Spatulated blades

	Length		
TI-529-4556	13"	33cm	Rigid
TI-529-4557	16½"	42cm	Rigid
TI-529-4558	13"	33cm	Malleable
TI-529-4559	16½"	42cm	Malleable

Breast Dissector Curved, blunt blades

	Length	
TI-529-4564	12"	30cm



Grossman



Freeman



Freeman
(Stainless Steel)



Freeman
(Stainless Steel)



Ackermann



Mckissock

GROSSMAN Areola Marker

	Size
TI-530-4565	4 size in 1 40 / 44 / 48 / 52mm

FREEMAN Areola Markers with inner markings, made from light weight aluminium

	Size 2 in 1
TI-530-4566	34 / 36mm
TI-530-4567	38 / 42mm
TI-530-4568	45 / 50mm

FREEMAN Areola Markers made from stainless steel

	Size 1 in 1	Size 2 in 1
TI-530-4569	38mm	TI-530-4573 34mm / 36mm
TI-530-4570	42mm	TI-530-4574 38mm / 42mm
TI-530-4571	45mm	TI-530-4575 45mm / 50mm
TI-530-4572	50mm	

ACKERMANN Areola Markers

	Size
TI-530-4576	5 1/2" 14cm
TI-530-4577	6 1/4" 16cm

MCKISSOCK Areola Markers

	Size
TI-530-4578	38mm
TI-530-4579	42mm
TI-530-4580	45mm
TI-530-4581	50mm

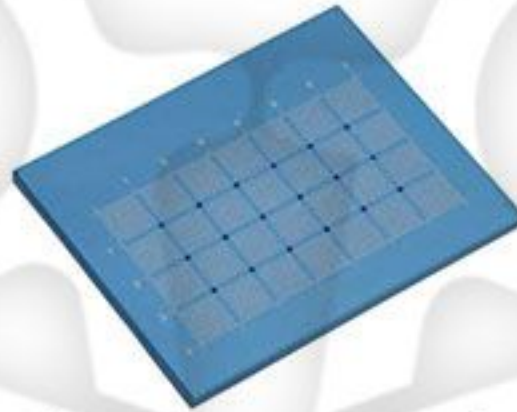

Sheen



Pitanguy



Pitanguy



D'assumpcao



Marten

SHEEN Grid

TI-531-4582

with mm graduation (70 x 40mm)
made from light weight Aluminium

PITANGUY Flap Grasping Forceps

Length

TI-531-4583 5 1/2" 14cm

PITANGUY Facial Demarcator

Length

TI-531-4584 6 1/4" 16cm

D'ASSUMPCAO Face-Lift Marker

Length 6 1/4" (16cm)

Ratchet

TI-531-4585 without ratchet

TI-531-4586 with ratchet

MARTEN Flap Marker

Length 5 1/2" (14cm)

Ratchet

TI-531-4587 without ratchet

TI-531-4588 with ratchet

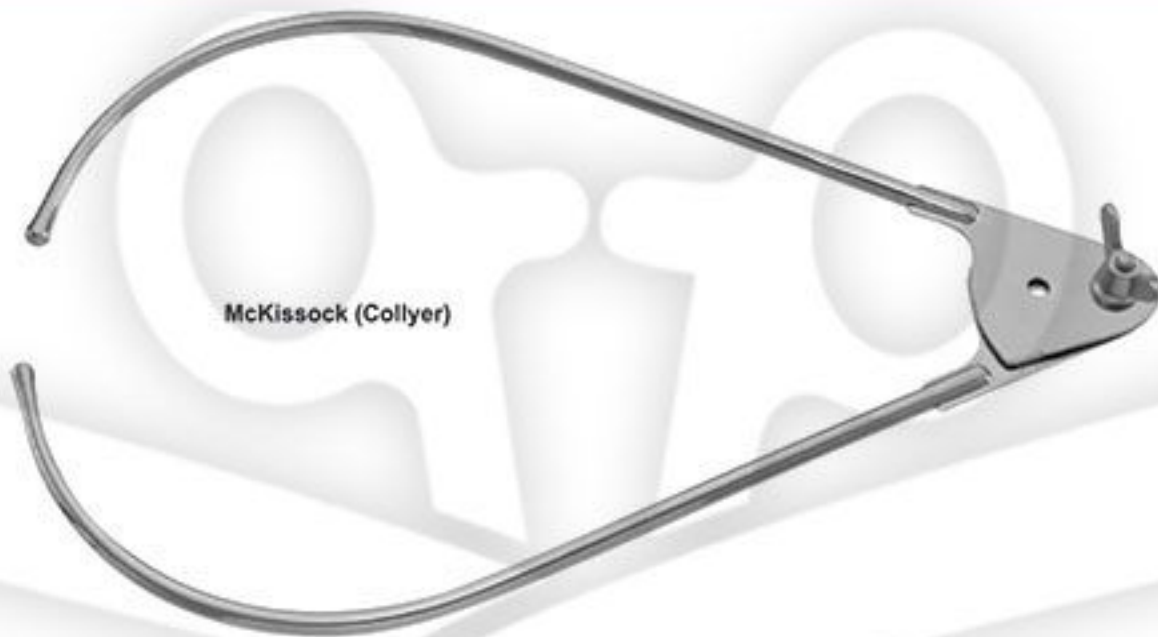

McKissock (Collyer)



Halpren



Castroviejo

MCKISSOCK (COLLYER) Caliper

	Size
TI-532-4589	12" 30mm

HALPREN Breast Caliper

	Size
TI-532-4590	34mm
TI-532-4591	38mm
TI-532-4592	42mm

CASTROVIEJO Caliper

Length 3 1/2" (9cm)

	Range
TI-532-4593	0-15mm
TI-532-4594	0-20mm

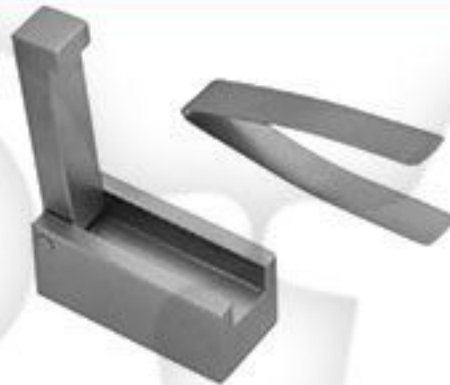

Cottle



Killian



Asch



Walsham

COTTLE Cartilage Crusher
with clip

TI-533-4595

Asch Septum Straightening Forceps

TI-533-4604 9" 23cm

KILLIAN Nasal Speculas
Length 5" 13cm

Speculas Only	with Light Guide	Working Length
TI-533-4596	TI-533-4600	35mm
TI-533-4597	TI-533-4601	50mm
TI-533-4598	TI-533-4602	75mm
TI-533-4599	TI-533-4603	90mm

WALSHAM Septum Straightening Forceps
Length 9" 23cm

TI-533-4605	straight
TI-533-4606	left
TI-533-4607	right



Scalp Elevators
Length 9 1/4" (24cm)

		Blade	Shape
A	TI-534-4608	12.5mm wide	slightly curved

		Blade	Shape
B	TI-534-4609	12.5mm wide	"S" Shaped

Scalp Elevators
Length 9 1/4" (24cm)

		Blade	Shape
C	TI-534-4610	15mm wide	slightly curved

		Blade	Shape
D	TI-534-4611	12.5mm wide	Slightly curved



Frontotemporal Dissectors

Length 9" (22.5cm)

A	Blades	Hook
TI-535-4612	5mm	slightly curved
B	Blades	Shape
TI-535-4613	7mm	slightly curved
C	Blades	Shape
TI-535-4614	10mm	slightly curved

Frontolabellar Dissectors

Length 10 1/2" (26.5cm)

D	Size	Shape
TI-535-4615	7mm tip	"S" Shaped



E



F



G



H

Scalp Elevators

Length 9 3/4" (24cm)

E	Blades	Shape
TI-536-4616	7mm wide	straight

F	Blades	Shape
TI-536-4617	7mm wide	slightly curved

G	Blades	Shape
TI-536-4618	7mm wide	strongly curved

Scalp Elevators with Suction

Length 9 3/4" (24cm)

H	Size	Shape
TI-536-4619	7mm wide	slightly curved

Length 10 1/4" (26cm)

	Blades	Shape
TI-536-4620	8.5mm wide	slightly curved



Flap Dissectors

Length 9½" (23.5cm)

A	Blades	Shape
TI-537-4621	5mm tip	straight

Zygomatic Arch Elevator

Length 8¼" (20.5cm)

B	Blades	Shape
TI-537-4622	5mm tip	curved tip

Orbital Rim Dissectors

Length 9" (22.5cm)

C	Shape
TI-537-4623	slightly curved

Temporal T-Dissectors

Length 9½" (23.5cm)

D	Size	Shape
TI-537-4624	10mm tip	slightly curved



Periosteal Elevators

A	Size	Blade	Shape
TI-538-4625	10" 25cm	12mm	"S" Shape

Periosteal Spreaders

B - C	Size	Blade	Shape
TI-538-4626	9 3/4" 24cm	8 mm wide	"S" Shape
TI-538-4627	9 3/4" 24cm	10mm wide	"S" Shape



Arcus Marginalis Dissectors
Length 9 3/4" (24cm)

A	Blades	Shape
TI-539-4628	10mm tip	"S" Shape

Midface Facial Dissectors
Length 9 3/4" (24cm)

B	Blades	Shape
TI-539-4629	12mm tip	Multiple curves

Transoral Dissectors
Length 9 3/4" (23.5cm)

C
TI-539-4630



Corrugated & Procerus Muscle Dissectors

Length 7 3/4" (19.5cm)

A	Blades
TI-540-4631	4.7mm tip

Nerve Protector

Length 6 3/4" (17cm)

B - C	Blades	Shape
TI-540-4632	4.5mm	curved left
TI-540-4633	4.5mm	curved right

Nerve Cutting Knife

Length 6 3/4" (17cm)

D	Blades	Shape
TI-540-4634	3mm	curved

Knife Handle for Plastic Surgery

Length 8 1/4" (20.5cm)

E
TI-540-4635

Nerve Hook

Length 9 3/4" (24cm)

F	Shaft
TI-540-4636	Right
TI-540-4637	Malleable



Nerve Dissector
Length 9 $\frac{3}{4}$ "(24cm)

A	Blade
TI-541-4638	4,7mm

Nerve Hook
Length 9 $\frac{3}{4}$ "(24cm)

B - C	Hook
TI-541-4639	Left
TI-541-4640	Right



Light Guide Cable



Light Guide Cable (Without Adaptors)

Black	Gray		
TI-542-4641	TI-542-4645	6 feet 183 cm	Ø 3.5mm
TI-542-4642	TI-542-4646	7.5 feet 229cm	Ø 3.5mm
TI-542-4643	TI-542-4647	6 feet 183 cm	Ø 5.0mm
TI-542-4644	TI-542-4648	7.5 feet 229cm	Ø 5.0mm

Instruments end adaptors for cables

Adaptor	Types
TI-542-4653	Wolf
TI-542-4654	ACMI British Standard
TI-542-4655	Storz

Light Source end adaptors for cables

Adaptor	Types
TI-542-4649	Olympus
TI-542-4650	Storz
TI-542-4651	ACMI British Standard
TI-542-4652	Wolf

25

LIPO-SUCTION INSTRUMENTS



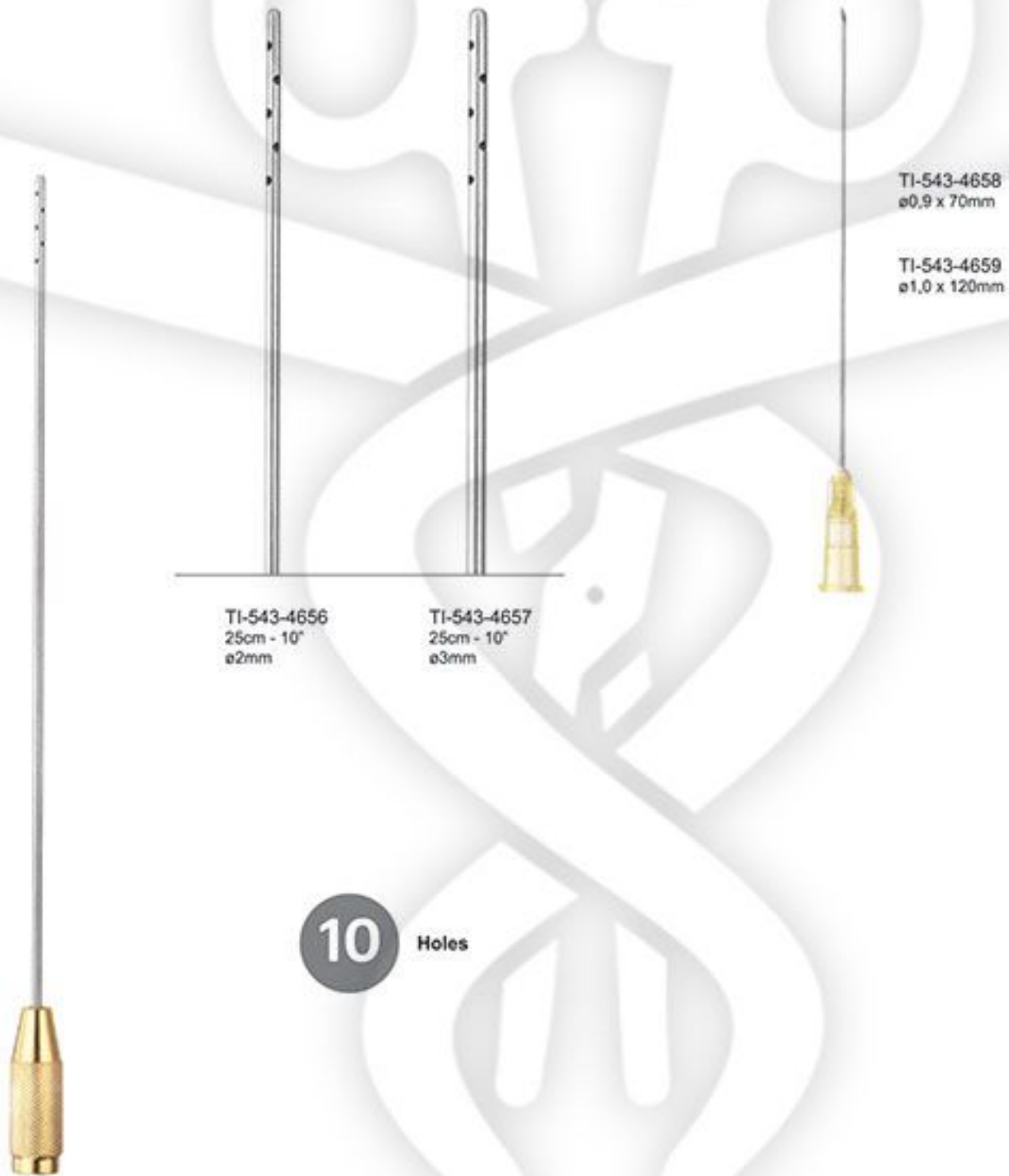

Measurements = working length

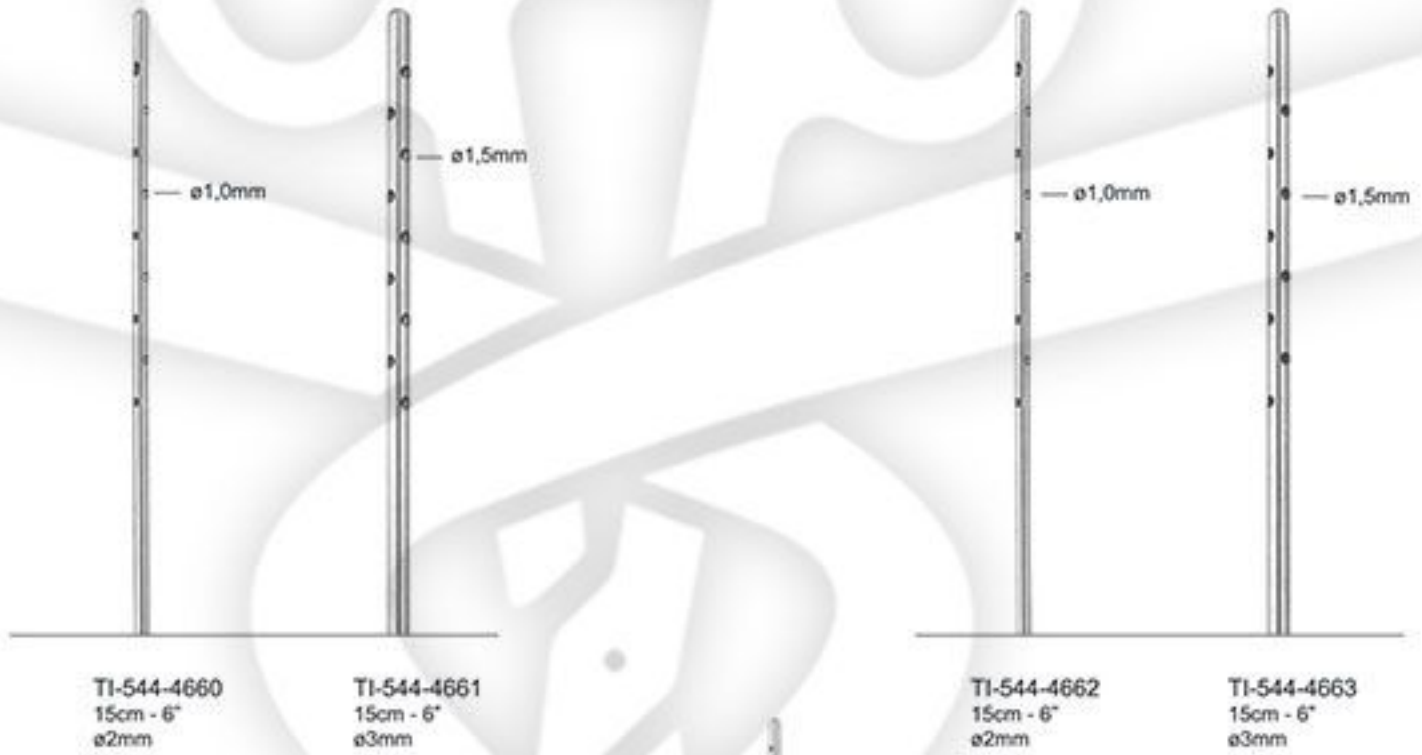

18 Holes

18 Holes

Measurements = working length

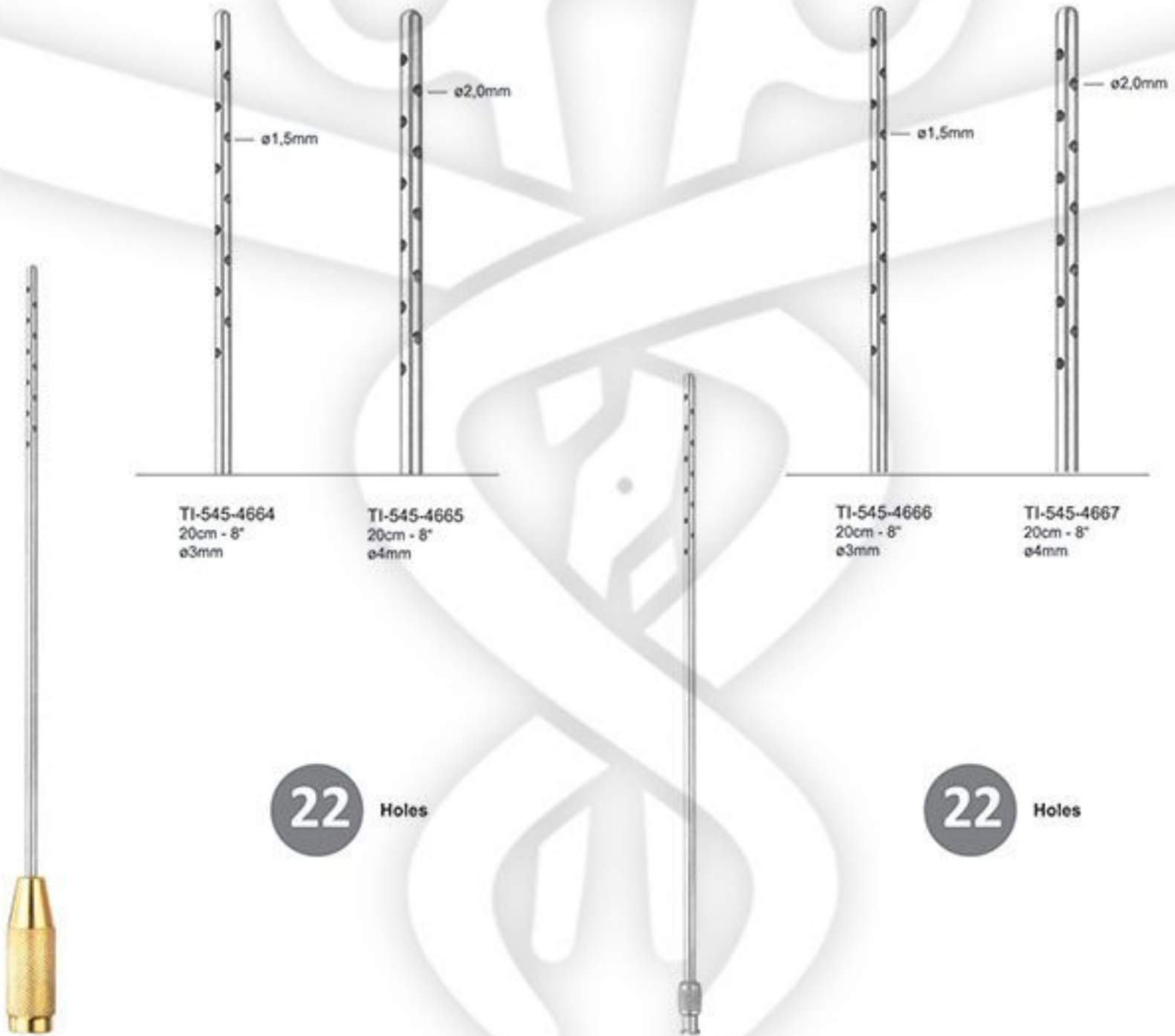

Measurements = working length

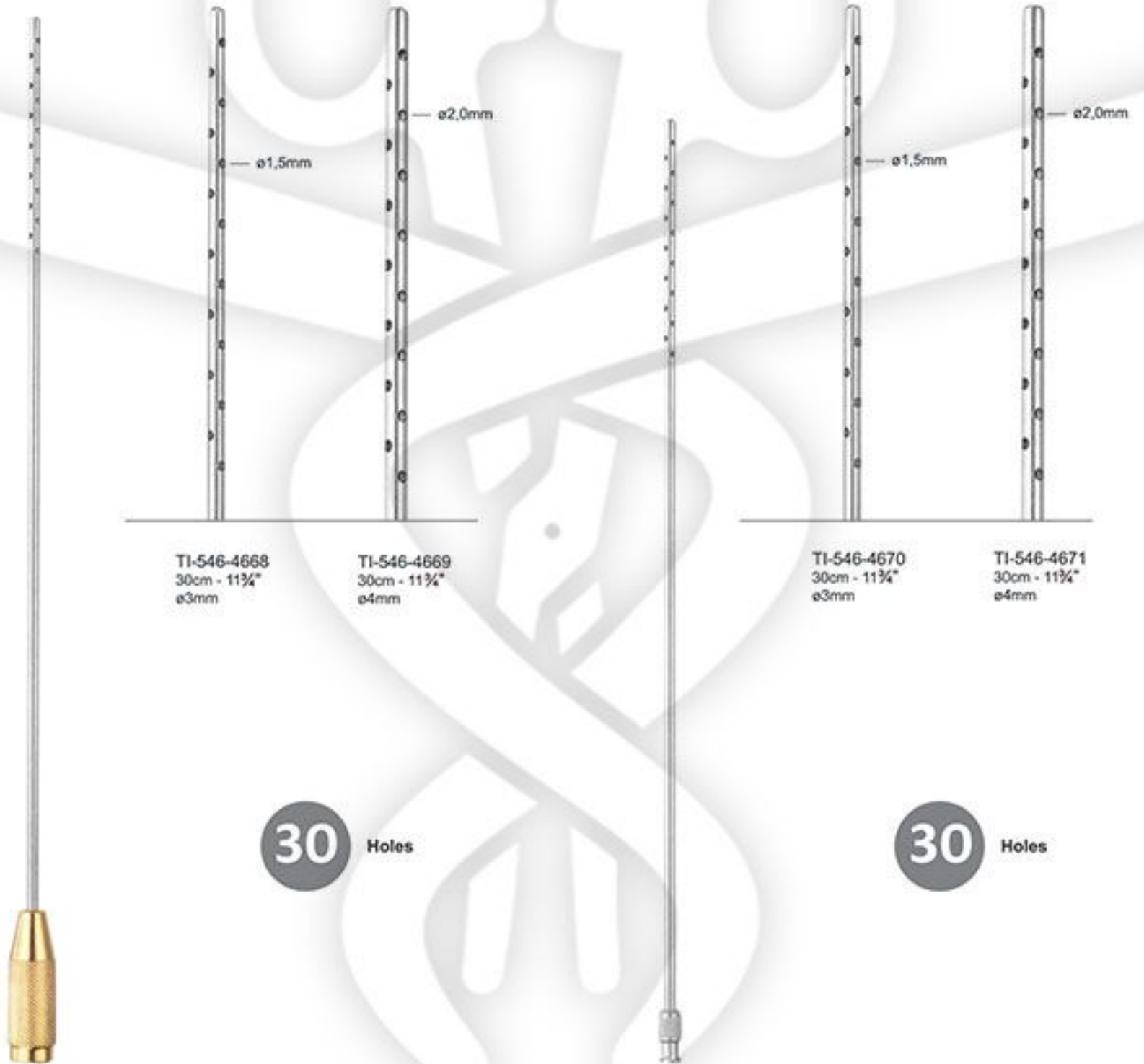

Measurements = working length

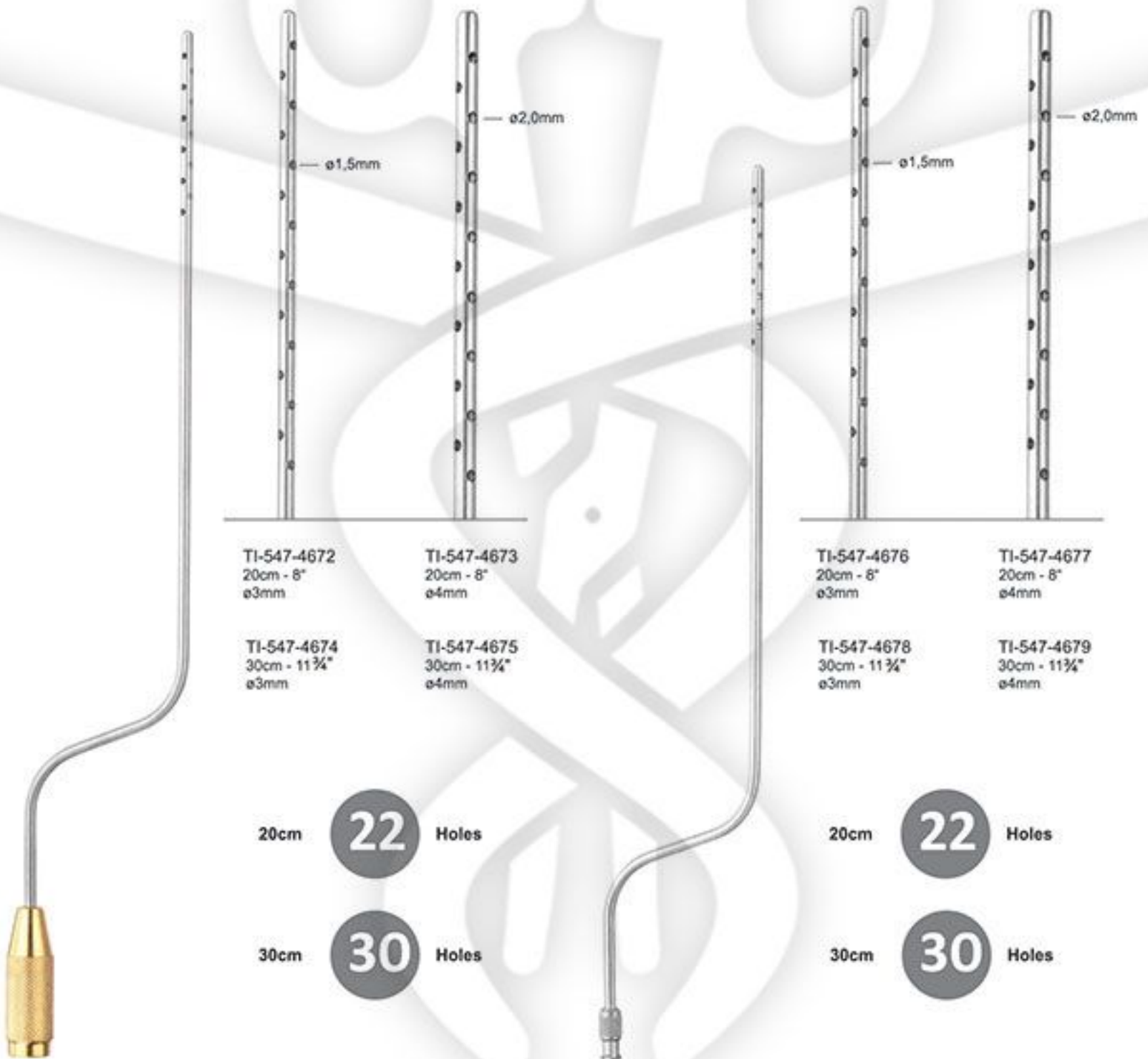

Measurements = working length

The bayonet shaped handles allow an easier manipulation.

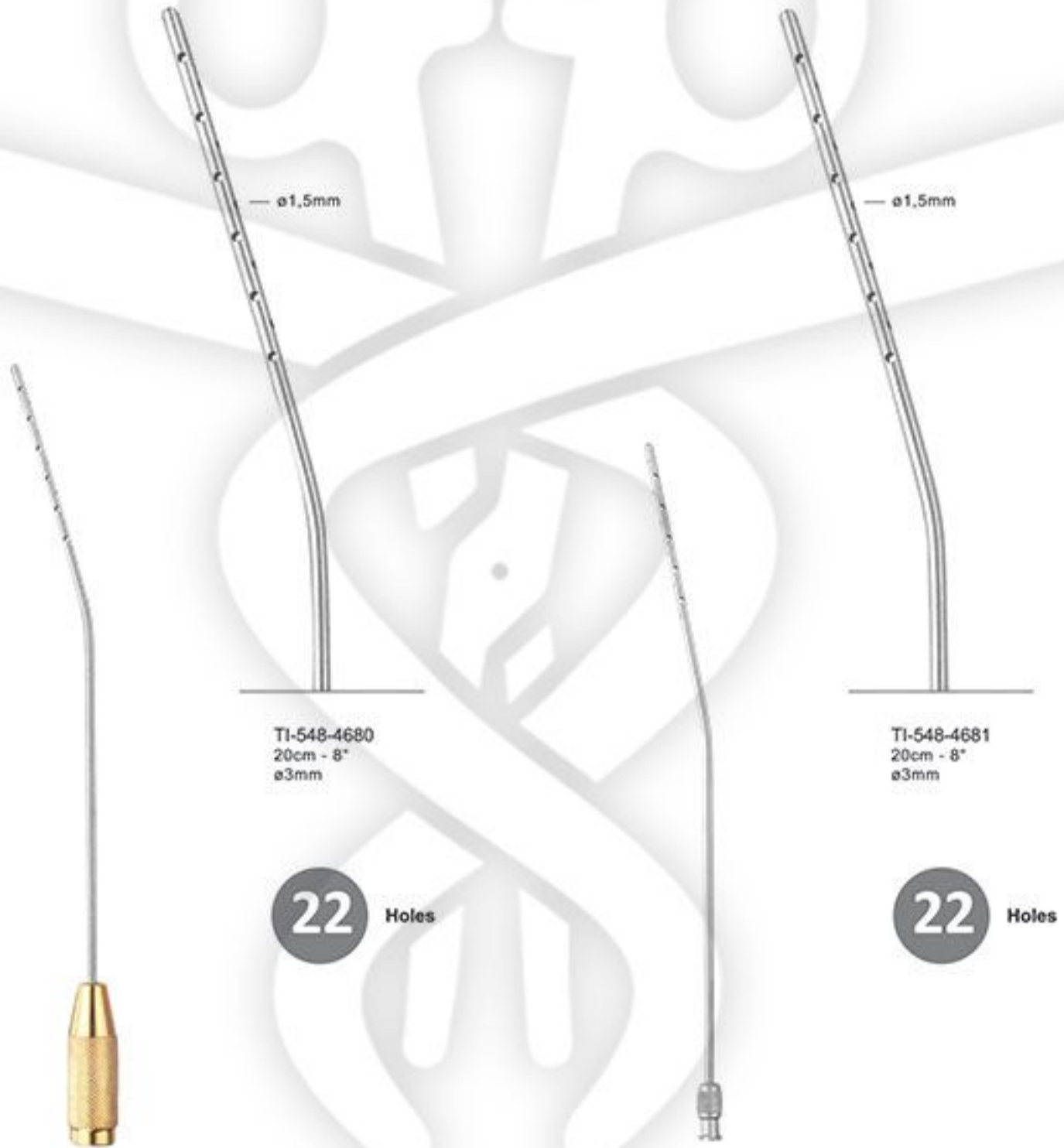

Measurements = working length

For fine proportioning in facial and neck areas.

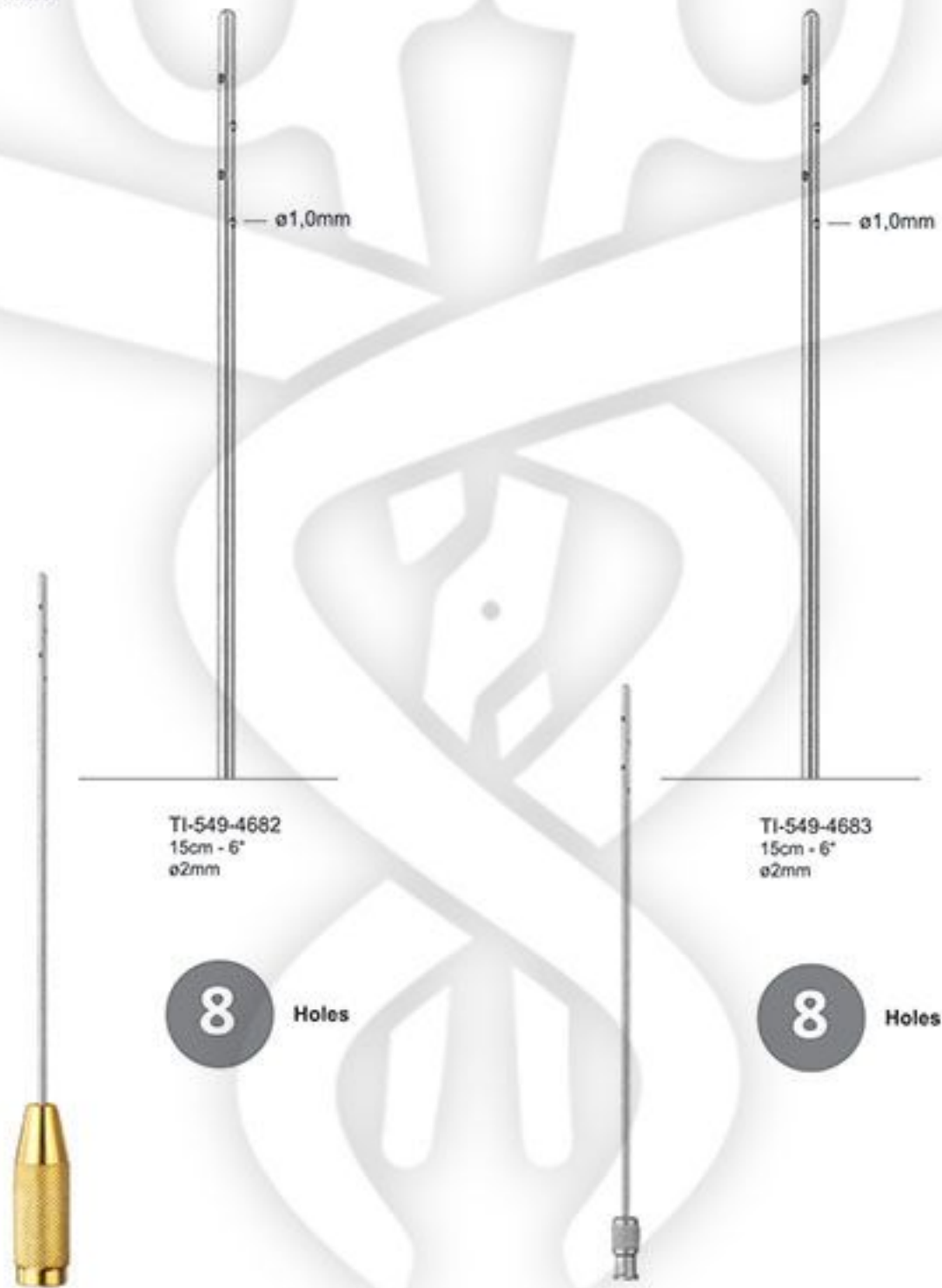

1

Face



- ① TI-550-4684 15cm, ø 2,0mm
- TI-550-4685 5 cm, ø 1,7mm
- ② TI-550-4686 15cm, ø 1,7mm

2

Neck



- ① TI-550-4687 15cm, ø 3,0mm
- ② TI-550-4688 20cm, ø 3,0mm
- ③ TI-550-4689 15cm, ø 2,0mm
- TI-550-4690 5 cm, ø 2,0mm
- TI-550-4691 5 cm, ø 3,0mm
- ④ TI-550-4692 15cm, ø 2,0mm
- TI-550-4693 15cm, ø 3,0mm

3

Thigh - Lower leg



- TI-550-4694 20cm, ø 3,0mm
- TI-550-4695 30cm, ø 3,0mm
- TI-550-4696 20cm, ø 4,0mm
- TI-550-4697 30cm, ø 4,0mm

Fork shape, rounded tips, dissector between tips / one central hole.

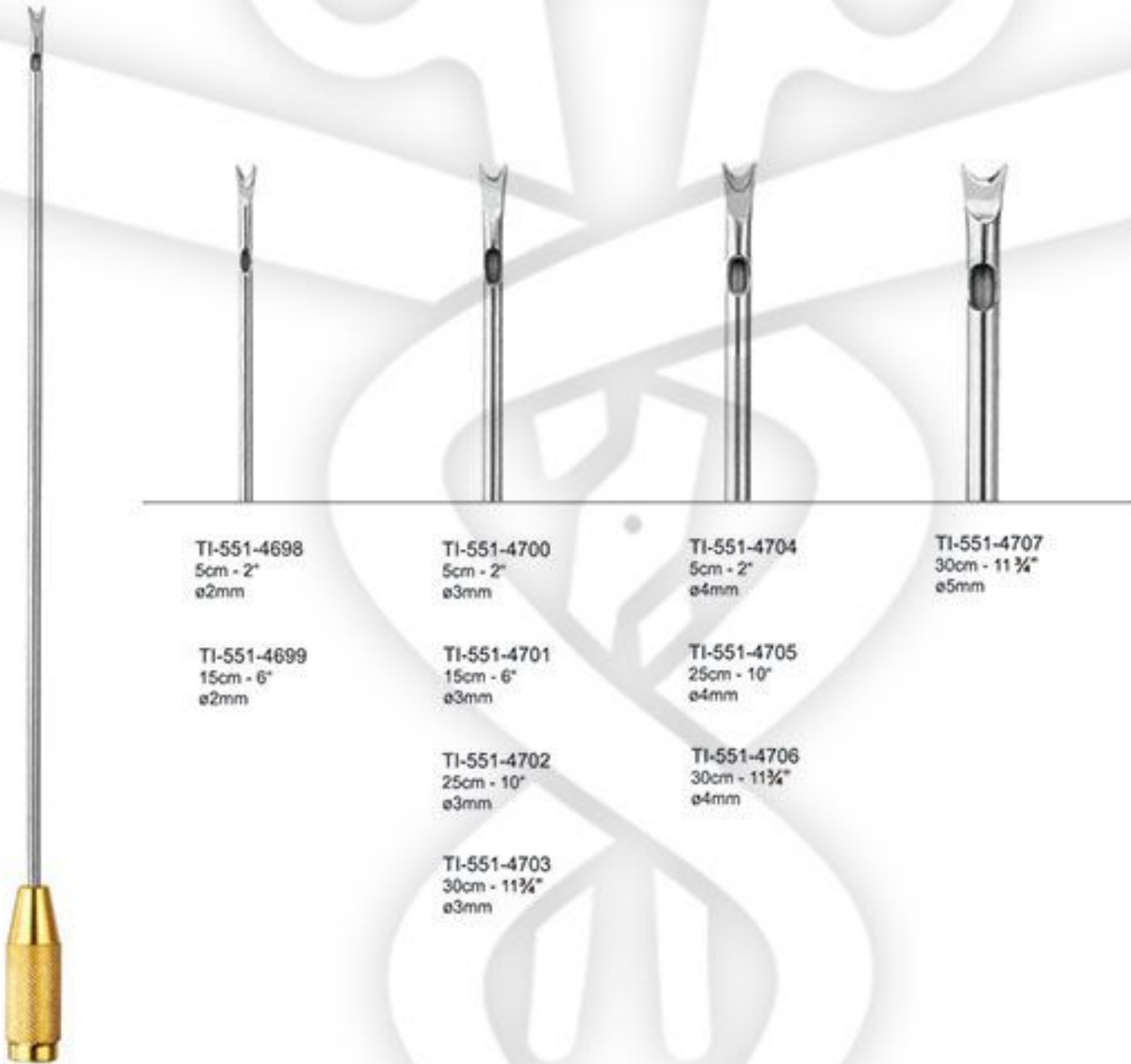

Measurements = working length



Measurements = working length

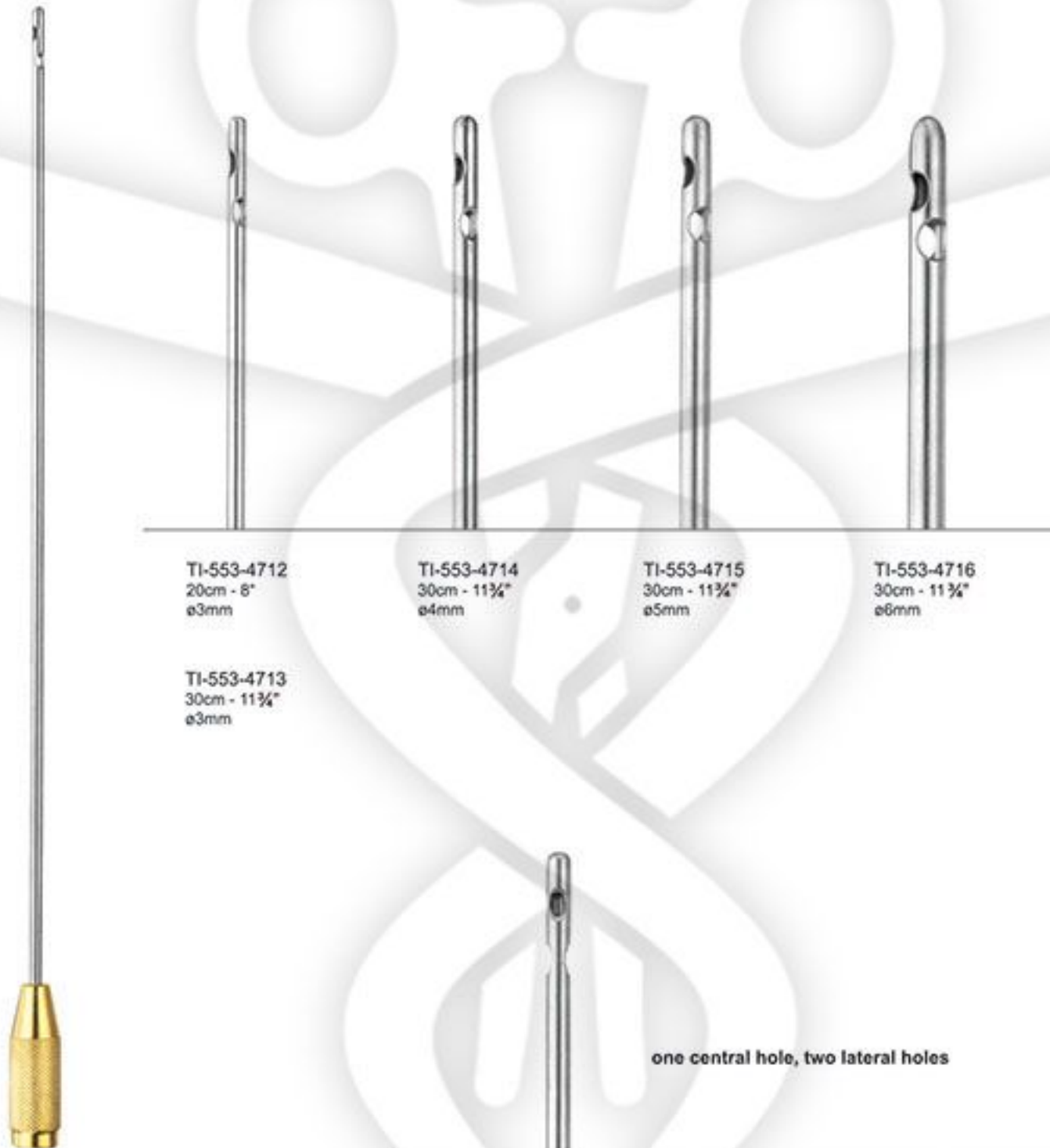

Measurements = working length



TI-554-4717
20cm - 8"
ø3mm

TI-554-4719
30cm - 11¾"
ø4mm

TI-554-4720
30cm - 11¾"
ø5mm

TI-554-4721
30cm - 11¾"
ø6mm

TI-554-4718
30cm - 11¾"
ø3mm



two lateral holes, one central hole

Measurements = working length

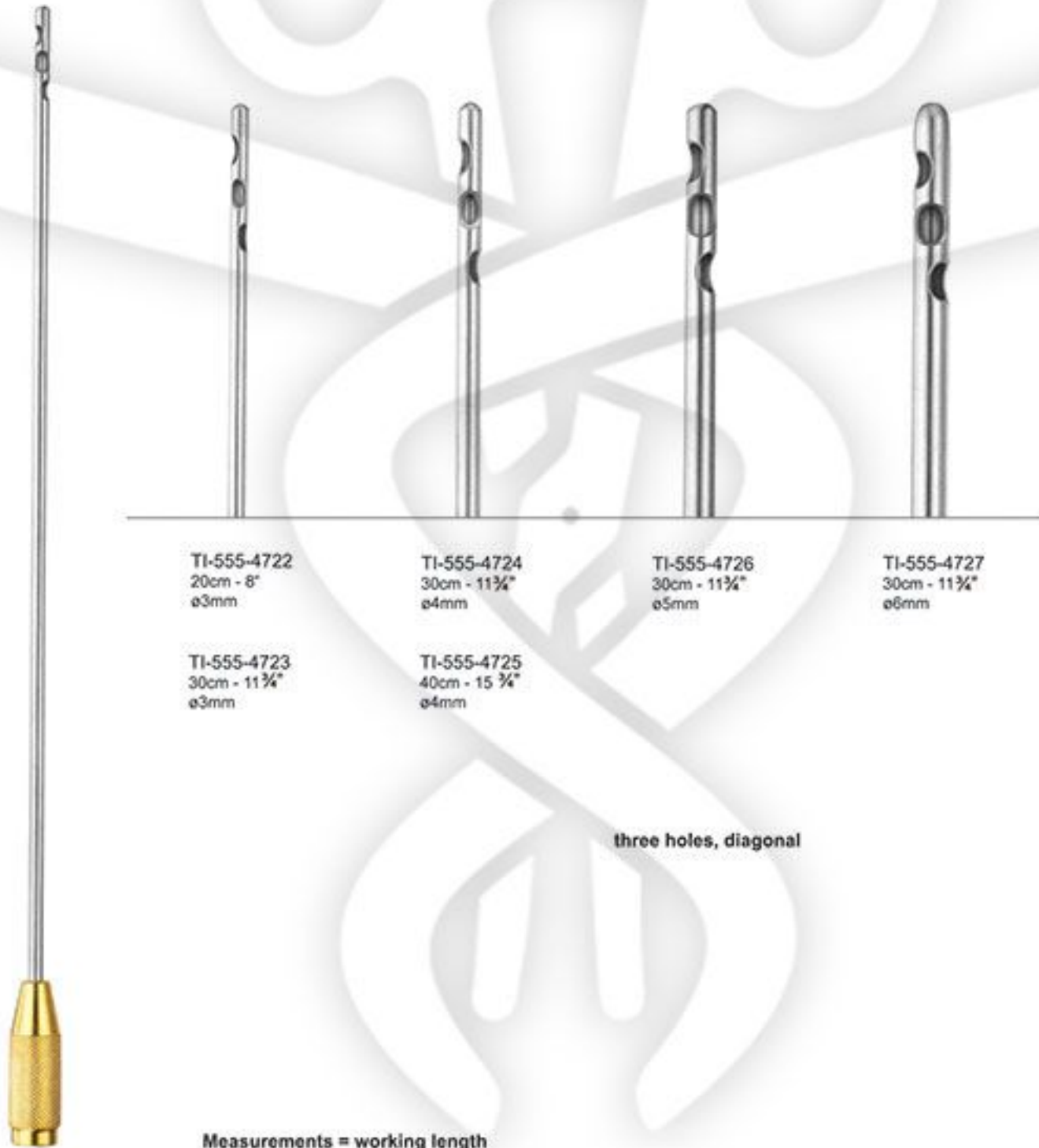

TI-555-4722
20cm - 8"
ø3mm

TI-555-4724
30cm - 11 3/4"
ø4mm

TI-555-4726
30cm - 11 3/4"
ø5mm

TI-555-4727
30cm - 11 3/4"
ø6mm

TI-555-4723
30cm - 11 3/4"
ø3mm

TI-555-4725
40cm - 15 3/4"
ø4mm

three holes, diagonal

Measurements = working length

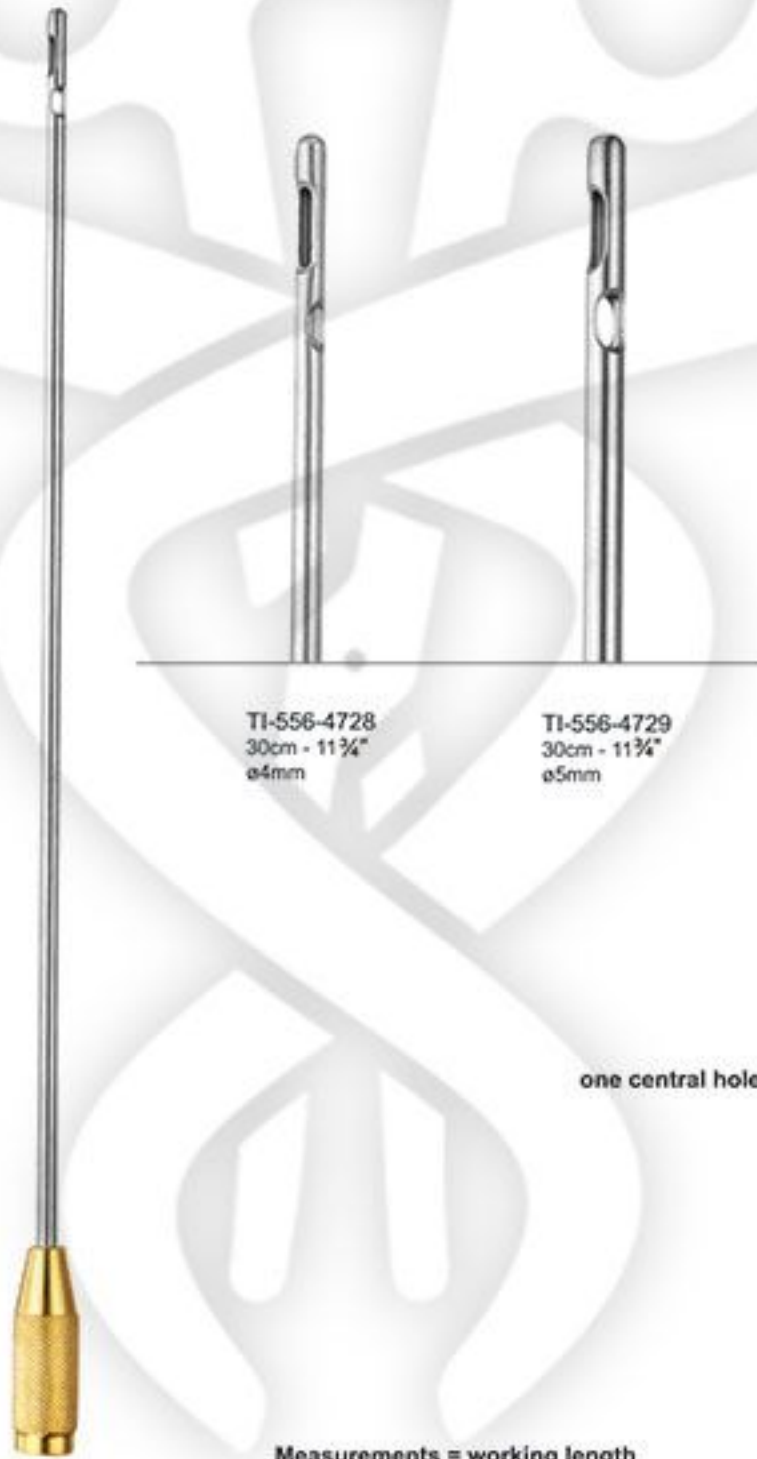

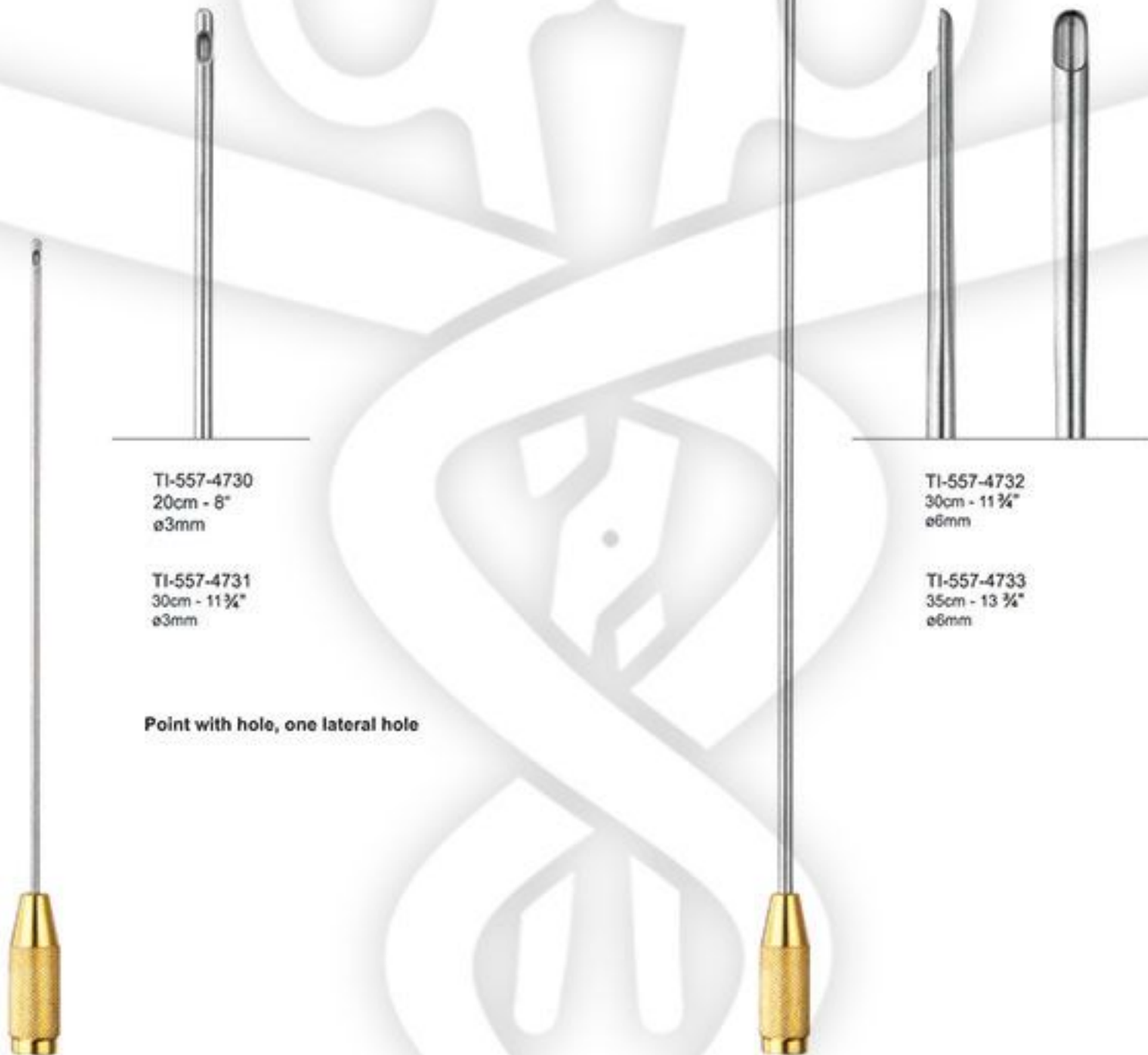

Measurements = working length

For fine proportioning in facial sections.



one lateral hole

Tl-558-4734
5cm - 2"
ø1,7mm

Tl-558-4736
5cm - 2"
ø2mm

Tl-558-4738
5cm - 2"
ø3mm

Tl-558-4735
15cm - 6"
ø1,7mm

Tl-558-4737
15cm - 6"
ø2mm

Tl-558-4739
15cm - 6"
ø3mm

with handle connector

Tl-558-4740
5cm - 2"
ø1,7mm

Tl-558-4742
5cm - 2"
ø2mm

Tl-558-4744
5cm - 2"
ø3mm

Tl-558-4741
15cm - 6"
ø1,7mm

Tl-558-4743
15cm - 6"
ø2mm

Tl-558-4745
15cm - 6"
ø3mm

with Luer Lock connection

Measurements = working length

Handles with connection thread for cannulas and hose connection $\varnothing 13\text{mm}$ for operation with a suction pump.



TI-559-4746



TI-559-4747
With rotatable tube connection

Recommended handles for the tumescence local anaesthesia technique



+



TI-560-4748

Hole for interruption of suction



TI-560-4749
With rotatable tube connection

360°

Lipo-Suction cannulas, stainless steel with thumb plate and hose connection $\varnothing 13\text{mm}$, for use with a suction pump.



TI-561-4750
15cm - 6"
 $\varnothing 3\text{mm}$

TI-561-4751
25cm - 10"
 $\varnothing 4\text{mm}$

TI-561-4752
15cm - 6"
 $\varnothing 6\text{mm}$

TI-561-4753
25cm - 10"
 $\varnothing 6\text{mm}$

TI-561-4754
30cm - 11 $\frac{3}{4}$ "
 $\varnothing 9\text{mm}$

one central hole

Measurements = working length

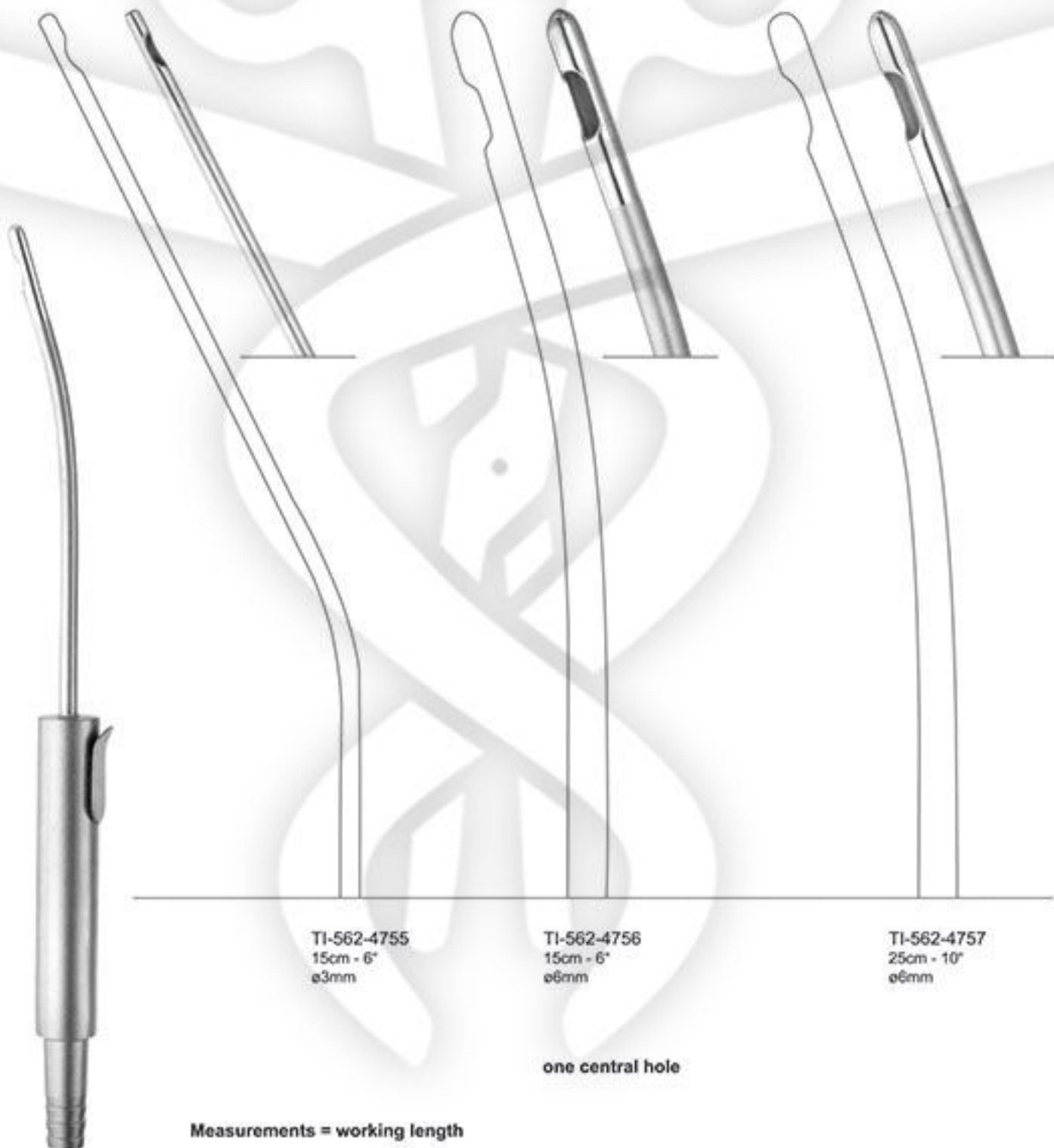

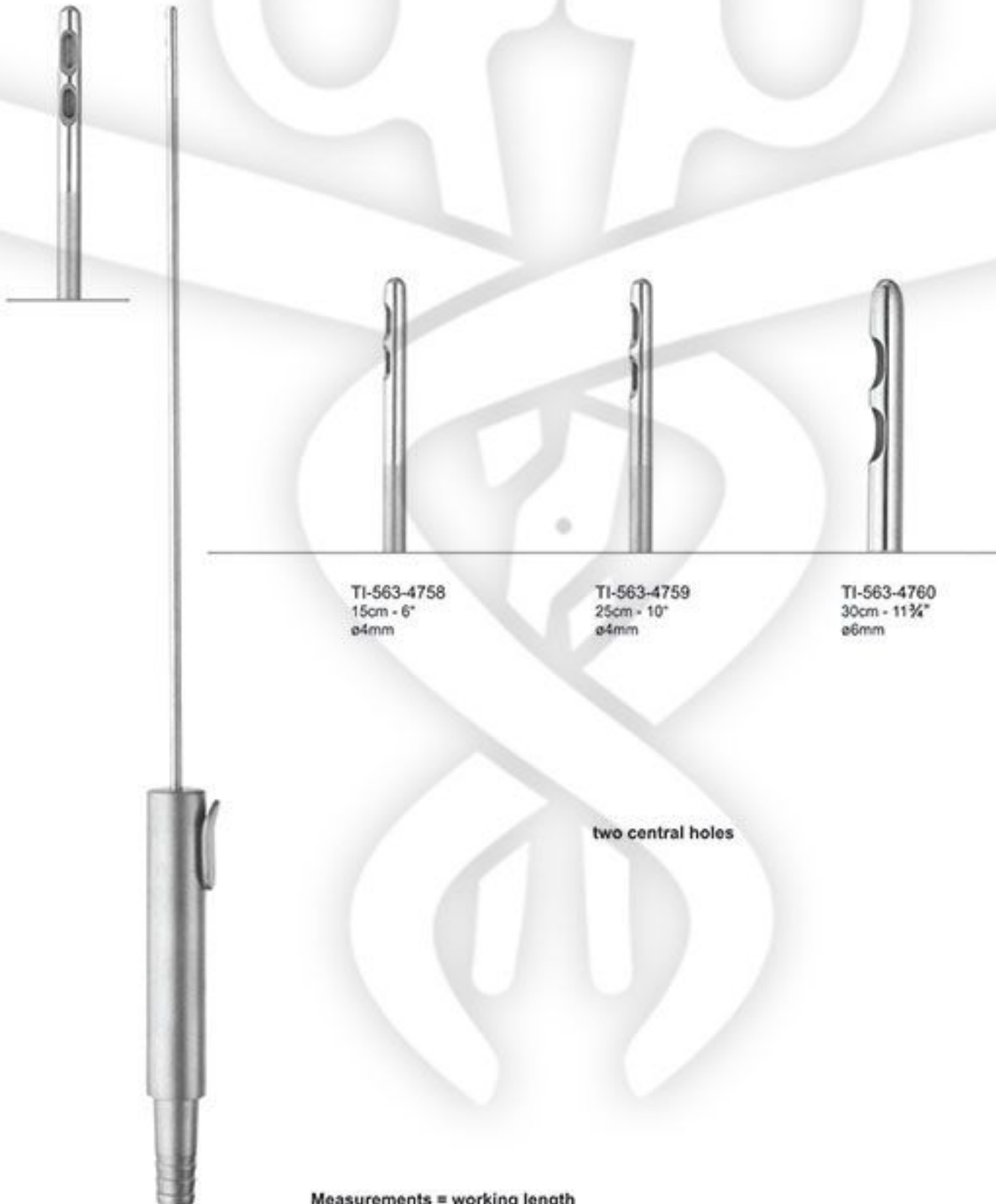

ALPHABETICAL INDEX



TALC INDUSTRIES
ONE STOP FOR MEDICAL EQUIPMENT



Barr Anal Retractors	359	Bone Holding Forceps Lane	233
Barraquer Cilia Forceps	499	Bone Holding Forceps Percy	234
Barraquer Iris Scissor	512	Bone Holding Forceps Verbugge	234
Barraquer Needle Holders	501, 503	Bone Holding Forceps	226-234
Barraquer Needle Holders	163	Bone Holding Forceps Ulrich	231
Barraquer Needle Holders	164, 176	Bone Hooks	213
Barth Curettes and Spoons	434	Bone Iris Forceps	491
Basic Orthopedic Set	259-268	Bone Iris Forceps	491
Beacham Tenaculum Forceps	376	Bone Levers Hohmann	221-223
Beck Atrauma Cardiovascular Forceps	331	Bone Levers	221-224
Beckmann Adenoid Curettes	300-301	Bone Pry	260
Beckmenn Retractors	141-142, 143	Bone Ronguer Forceps Blumenthal	237
Beerke Capsule Forceps	501	Bone Ronguer Forceps Cleveland	235
Bending Spanner	259	Bone Ronguer Forceps Friedmann	235
Bennett Spinal Retractors	224	Bone Ronguer Forceps Hartmann	236
Bergmann Bandage Scissors	185	Bone Ronguer Forceps Luer	237
Berliner Percussion Hammers	153	Bone Ronguer Forceps Mead	235, 236
Bessler/Treat' Suture Forceps	481	Bone Ronguer Forceps	235-241
Beyer Bone Ronguer Forceps	238	Bone Ronguer Forceps Lempert	236
Beyer Punches	432	Bone Ronguer Forceps Stellbrik	235
Billeau Loops, Foreign Body, Hooks	435	Bone Suture Forceps	491
Billrot Trocars	157	Bonney Dressing Forceps	100
Biopsy Forceps	480	Bose Laborde	362
Biopsy Forceps	480	Botvin Iris Forceps	489
Biopsy Hook Forceps	480	Bowman Lacrimal Probes	514
Biopsy Instruments	480	Bozeman Forcep	080
Biopsy Punches	480	Bozeman-Douglas	080
Bishop-Harmon Iros Forcep	489	Bozemann Needle Holder	181
Bircher Menisectomy Knives	225	Bracken Fixation Forceps	490
Bladder Retractors Millin	357	Brain Leyla Retractor Double	418
Bladder Retractors	357	Brain Leyla Retractor Single	418
Blohmke Tonsil Seizing Forceps	452	Brain leyla Retractor	418
Blount Spinal Retractors	224	Brain Spatulas	399
Blumenthal Bone Ronguer Forceps	237	Braun Tenaculum Forceps	375, 380
Bodenhammer Rectal Speculum	359	Braun-Stadiur Epislomy Scissors	30
Body Forceps Gross Maier	79	Breisky Obstetrical forceps	391
Bohier Bone Ronguer Forceps	238	Brinkerhoff Rectal Specula	360
Boilate Tounge Depressors	443	Britton Angle Rongeur Scissors	263
Bonaccolto Utility Forceps	495	Britton Asseous Pin Bending Forceps	265
Bone And rib Shears Gluck	303	Britton Bedside Traction rack	264
Bone And rib Shears Stille	303	Britton Blouse Rack	264
Bone And rib Shears	303	Britton Bone Krishnor Scissors	265
Bone Chisels Alexander	195	Britton Rejection Forceps	264
Bone Chisels Buckley	194	Britton safely Screwdriver	261
Bone Chisels Mini-Lambotte	197	Britton Spine Retractor	266
Bone Chisels Partsch	195	Broken Nail Extractor	261
Bone Chisels Stille	196	Broken Nail Hollow Saw	260
Bone Chisels	194-200	Broncho-Esophagoscopy Forceps	455
Bone Curette	260	Bronchus Clamps	62
Bone Curettes and Hook	213	Brown Needle Holders	167
Bone Curettes Mod.USA	210	Brophy	043
Bone Curettes Schede	208	Bruenings Broncho-Esophagoscopy Forceps	455
Bone Curettes Simon	210	Bruenings Cutting and Grasping Forceps Tips	456
Bone Curettes Spratt	208	Bruenings Polypus	277
Bone Curettes Volkman	207, 208, 211	Bruenings Tonsil Knives	450
Bone Curettes Williger	211	Bruenings Tonsil Snares	453
Bone Curettes	207-212	Bruenings Tounge Depressors	443
Bone Curettes	214	Bruenings-Brunk	302
Bone Curettes Bruns	208, 209	Bruenings swivel knife	287
Bone Curettes Halle	210	Brunner Intestinal Clamp Forceps	341
Bone Curettes Martini	211	Brunner Retractors	122
Bone Curettes Williger	209	Brunner Sternum Scissors	304
Bone Drills	249	Bruns Bone Curettes	208, 209
Bone File Osteotribe	261	Bruns Oval Cup Curettes	212
Bone Flat Chisels	259	Bruns Plaster Shears	186
Bone Hammer	259	Bruns Plaster Shears	187
Bone Holding clamps	251	Buchwald Tounge Depressors	443
Bone Holding Clamps	262	Buck Curettes and Spoons	434
Bone Holding Forceps Dingamann	226	Buck Curettes	433

Buck Percussion Hammers	152
Buckley Bone Chisels	194
Buckley Retractors	132
Buck-Gremcko Gouge	195
Buelau Trocars	156
Bulldog Clamps	48, 311
Bullet-Nose Dissecting Forceps	475
Burret Tenaculum Forceps	374
Busch Umbilical Scissors	31
Byrd Suction Tubes	162

C

Caliper	193
Callipers Casterveijo	513
Callipers Eye	513
Callipers Jameson	513
Callipers Thorpe	513
Campbell Trocars	156
Cannulated Pin Cutter	190
Caplan Septum Scissors	282
Capsule and Muscle Forceps	501
Capsule Fragment and Clot Forceps	501
Carbide inserts Metzenbaum	88-91
Cardiovascular	98-99
Carpenter Tonsil Knives	451
Carter Periosteal elevator	290
Castanares Face Lift Scissors	95
Casterveijo Callipers	513
Casterveijo Capsule Forceps	501
Casterveijo Corneal Section Scissors	510
Casterveijo Iris Scissor	510
Casterveijo Marking Callipers	513
Casterveijo Needle Holders	502
Casterveijo Suture Forceps	492
Casterveijo Utility Forceps	495
Castroviejo Needle Holders	165-166, 176
Catchers	353
Cather Dilating Bougles	358
Catheter Forceps	457
Cervical Biopsy Gelhorn	385
Cervical Biopsy	385, 387
Cervical Biopsy Faaure	385
Cervical Vertebrae Trephine	266
Cervical Vertebra Retractor	268
Chalazian Forceps Francis	500
Chalazion Forceps Desmarres	500
Chalazion Forceps Health	500
Chalazion Forceps Hunt	500
Chalazion Forceps Lambert	500
Chalazion Forceps Lordon	500
Chalazion Forceps Snellen	500
Chalazion Forceps	500
Chandler Iris Forceps	496
Charrre	248
Cheron Forceps	080
Chelsea-Eaton Anal Speculum	360
Chevalier-Jackson Forceps	455
Chin, Chanselled	445
Cholangiogram Clamp	481
Cilia Forceps	47, 499
Cinelli Rhinoplastic Instruments	291
Citelli Punches	432
Clamps Forceps	71
Claw Grasping Forceps	469
Clayman Lens Flayer	499
Cleveland Bone Ronguer Forceps	235

Clothing Scissors	186
Clover Tonsil Seizing Forceps	452
Cloward Invertible Disc Rongeurs	405-407
Cloward Retractors	140
Cloward	404
Coakley Sharp Curettes	299
Cobb-Type Oval Cup Curettes	212
CogosWell Suction Tubes	162
Cohan Needle Holders	503
Cohen Cuticle Nippers	270
Colclough Invertible Disc Rongeurs	406-408
Collin Mouth Gags	441
Collin Obstetrical forceps	391
Collin Tounge Depressors	443
Collin Uterine Elevating Forceps	383
Collin Vaginal Specula	363-364
Combined reamer	267
Compression Instrument	266
Conductor Steel Tyre	268
Cone Ring Curettes	214
Cone Ring Curettes	214
Converse Rhinoplastic Instruments	286, 295
Cooley Atrauma Cardiovascular Forceps	333-336
Cooley Atrauma Tissue Forceps	310
Cooley Rib Spreaders	305
Cooley Suction Tubes	161
Collier	167
Collin Forceps	049
Collin Mallets	202
Collin Retractor	147
Cordes Cutting and Grasping Forceps Tips	456
Cottle Dorsal Scissors	97
Cottle Nasal Knives	286
Cottle Nasal Scissors	29
Cottle Nasal Specula	274
Cottle Rhinoplastic Instruments	292, 294-295, 297
Cottle septum elevator	289, 290
Cottle-Kazanjian Bone Ronguer Forceps	242
Cottle-Walsham Rhinoplastic Instruments	298
Cotton applicators	7
Cotton applicators Fein	7
Cotton applicators Playfair	7
Cotton carrier for rectoscope Cotton applicators	7
Cotton Swab Forceps	80
Countersink Drill	260
Coupland Suction Tubes	162
Coxter Curettes and Spoons	434
Crafoard Thorax Scissors	25
Crile Artery Forceps	53
Crile-Murray Needle Holders	168
Crile-Wood Needle Holders	177
Craig polypus Forcep	277
Cross-Serations Artery forceps	50
Crura & Malleus Nippers	424
Curettes and Spoons	434
Curettes Randall Suction Biopsy	384
Curettes Suction Biopsy	384
Curettes	433
Curettes	437
Cusco Vaginal Specula	363-364
Cushing Brain Spatulas	399
Cushing Dressing Forceps	38
Cushing Dura Hooks	403
Cushing Hand Drills	250
Cushing Laminectomy Rongeurs	410
Cushing Nerve Hooks	401
Cushing Periosteal Raspatories	215
Cushing taylor	101
Cushing Retractors	101-109

Cuticle Nippers	270
Cuticle Nippers Cohen	270
Cuticle Scissors	270
Cutting and Grasping Forceps Tips Bruenings	456
Cutting and Grasping Forceps Tips Cordes	456
Cutting and Grasping Forceps Tips Fraenkel	456
Cutting and Grasping Forceps Tips Frankel	456
Cutting and Grasping Forceps Tips Krause	456
Cutting and Grasping Forceps Tips Lange	456
Cutting and Grasping Forceps Tips Rosenberg	456
Cutting and Grasping Forceps Tips Schumacher	456
Cutting and Grasping Forceps Tips Seiffert	456
Cutting and Grasping Forceps Tips	456
Czerny Tenaculum Forceps	380
Czerny Rectal Specula	347
Dale Cardiovascular Forceps	309

D

Dandy Artery Forceps	54
Dandy Elevators, Knives, Dura Hooks	402
Dandy Neurosurgical Scissors	28
Darling Retractors	145
Dartigue Uterine Elevating Forceps	383
Davis Dura Dissectors	397
Davis-Boyle Mouth Gags	440
Day Hooklets	436
De Bakey Atrauma Tissue Forceps	310
313- 315, 317-319, 324- 330, 332	
De Bakey Dressing Forceps	102
De Bekay	93, 178
Deaver Operating Scissors	14
De Bakey-Bahson Cardiovascular Forceps	326
De Bakey-Pean Cardiovascular Forcep	329
Deaver Retractors	124-126
Debakey Grasping Forceps	469
Dee Lee Obstetrical forceps	392
Dejerine Percussion Hammers	153
Denhart Mouth Gags	438
Depth Gauges	260
Derf Needle Holders	167, 177
Derra Atrauma Cardiovascular Forceps	331
Deschamps Reverdin Needle	174
Desjardins Artery Forceps	67
Desjardins Gall Stone Scoops	354
Desjardins Mayo-Blake Gall stone Forceps	353
Desk Typ Bending Forceps	264
Desmarres Chalazion Forceps	500
Desmarres Retractors	106
Detach Scissors System	478, 479
Diamant Tungstun Carbide	255
Diethrich Coronary Artery Scissors	99
Dietrich Vascular Scissor	26
Dieffenbach	048
Dietrich Needle Holder	175
Dilating Bougles	358
Dingamann Bone Holding Forceps	226
Dingman Mouth Gag	441
Disimpaction Forceps Rowe	449
Disimpaction Forceps	449
Dissecting Forceps	474-476
Dissecting Forceps	100-103
Dissecting Forceps	59
Dissecting Scissors	20
Dissecting Scissors	34
Dissecting Scissors Formon	23

Dissecting Scissors Metzenbaum	20
Dissecting Scissors Metzenbaum-Nelson	21-22
Dissectors Davis Dura	397
Dissectors Frazier Dura	397
Dittin Dilating Bougles	358
Double action Bone ronguers	263
Double Joint Outrigger Scissors	262
Double Use Guide Grill	259
Douglas Cilia Forceps	47, 499
Doyen Intestinal Clamp Forceps	341
Doyen Mallets	202
Doyen Myoma Instruments	382
Doyen operating scissors	19
Doyen Periosteal Raspatories	217
Doyen Probe	4
Doyen Retractors	121
Doyen Tounge Depressors	443
Doyen Uterine Polypus Forceps	381
Doyen Vaginal Specula	367
Doyen Vaginal Speculam	369
Doyen-Atrauma	346
Dressing and Cotton Swab	79
Dressing Forceps Adson	37
Dressing Forceps Cushing	38
Dressing Forceps De bakey	102
Dressing Forceps Ferris smith	100
Dressing Forceps Gerald	38
Dressing Forceps Gillies	100
Dressing Forceps Mc indoe	100
Dressing Forceps Mcindoe	37
Dressing forceps oehler	102
Dressing Forceps Semken	38
Dressing Forceps Taylor	38
Dressing Forceps	36-38
Dressing Forceps Eye	488
Dressing tampon	275
Dual-Cup Grabber Forceps	466
Duke Trocars	156
Duplay Tenaculum Forceps	375
Dura Dissectors	396, 397
Dura Hooks Adson	403
Dura Hooks Adson	403
Dura Hooks Cushing	403
Dura Hooks Fraizier	403
Dura Hooks Lahey	403
Dura Hooks Lahey	403
Dura Hooks	402
Dura Hooks	403
Dural Grasping Forceps	471
Dural Tissue and Organ Holding Forceps	43, 340

E

Ear Polypus Snares	429-431
Ear Specula Gruber	427
Ear Specula Hartmann	427
Ear Specula Toynbee	427
Ear Specula Zoliner	427
Ear Specula	427
Echlin Bone Ronguer Forceps	239
Elsching Fixation Forceps	490
Elevators Adson	219
Elevators Lempert	437
Elevators	402
Elevators	437
Elevators	219-220
Elliot Obstetrical forcep	392

Enucleation Fine Operating Scissor	34
Endarterectomy Scissors	98
Endspecula	370
Engel Saw	188
Ent Dignostic Set	464
Enucleation Scissor	509
Episiotomy Scissors Braun-Stadiur	30
Episiotomy Scissors Waldmann	30
Episiotomy Scissors	30
Epstain Spinal Curettes	214
Errico Hand Drills	250
Esmarch Clothing Scissors	186, 188
Eves Tonsil Snares	453
Excentric	185
Extansion Bows	256-257
Extansion Bows Kirschner	256
Eye Callipers	513
Eye Forceps Iris	488
Eye Forceps	488-489
Eye Scissors	508-512
Eye Dressing Forceps	488

Fixation Forceps	490
Flat Nose Pliers	252
Flat Nose Pliers	192
Fleurant Trocars	157
Fluher Probe	5
Foerstar Sponge Forceps	472
Foerster Polypus Forceps	81-82
Fomon Dissecting Scissors	23
Fomon Dorsal Scissors	97
Fomon Lateral Scissors	97
Fomon Rhinoplastic Instruments	286, 291, 295-296
Fomon Tonsil Scissors	29
Forceps Fine Tying	498
Forceps Littauer Cillia	499
Forceps Sinskey Tying	498
Forceps Cilia	499
Forceps Clips and Spplying	394
Forceps Gradle Cillia	499
Forceps Yasargil	485
Forceps Douglas Cillia	499
Forceps Lens	499
Forceps Watzke Sleeve Spreading	496
Forceps Ziegler Cillia	499
Forceps	482, 485, 487
Forceps Barraquer Cillia	499
Forceps Fixation	490
Forceps Microsurgical	482
Forceps Schaaf Foreign Body	496
Forceps Shepard Tying	498
Foreign Body Forceps	79
Fraenkel Cutting and Grasping Forceps Tips	456
Frazier Dura Hooks	403
Francis Chalazian Forceps	500
Frankel Cutting and Grasping Forceps Tips	456
Frazier Dura Dissectors	397
Frazier Suction Tubes	158
Freeman Rhytidectomy Scissors	96
Freeman-Gorney Face Lift Scissors	96
Freeman-Kaye face Lift Scissors	96
Freer Rhinoplastic Instruments	291, 295
Freer Septum elevators	288
Freer Septum knife	287
Frenzel Toungue Depressors	443
Friedman Endspecula	370
Friedmann Bone Ronguer Forceps	235
Frosch Bone Holding Forceps	227
Frykholm Bone Ronguer Forceps	240
Fuller Crura & Malleus Nippers	424
Fundus Grasping Forceps	466

F

Faure Cervical Biopsy	385
Fansler Operating Speculum	359
Fansler Rectal Speculum	360
Farabeuf Bone Holding Forceps	229
Farabeuf Periosteal Raspatories	216
Farabeuf Retractors	128
Faulkner Sharp Curettes	299
Faure Biopsy Forceps	385
Faure Artery Forceps	70
Fein Cotton applicators	7
Feichenfeld	046
Fergusson Bone Holding Forceps	227
Fergusson Vaginal Specula	363
Fergusson	355
Ferris-Smith Cup Jaw Rongeurs	417
Ferris-Smith Dressing Forceps	44, 100
Ferris-Smith-Kerrison	409
Ferris-Smith-Kerrison	283, 284
Fiber Optic Mccoy Laryngoscopes	463
Finocchietto Needle Holder	170, 180
Finchietto Needle Holders	170
Fine operating Enucleation Scissors	33
Fine operating Iris Scissors	34
Fine operating Scissor Strabismus	33
Fine operating Scissors	24
Fine operating Scissors	33, 34
Fine operating Scissors	24
Fine Tying Forceps	498
Finger Ring Saws	247
Finocchettio Artery Forceps	64
Finocchietto Rib Spreaders	306-307
Finocchietto-infant Baby	306
Finocchietto-infant	306-307
Finsen Retractors	131
Fish Probe	3
Fisher Tonsil Knives	450
Fisher Tonsil Knives	450
Fixation Forceps Bracken	490
Fixation Forceps Elaching	490
Fixation Forceps Green	490
Fixation Forceps Lester	490
Fixation Forceps Thorpe Conjunctional	490
Fixation Forceps Von Graefe	490

G

Galea Hooks	395
Gall Duct Clamps	62
Gallaher Rhinoplastic Instruments	294
Gall Duct Dilators	352
Gall stone Forceps	353
Gall Stone Scoops	354-355
Gelhorn Cervical Biopsy	385
Gelpi-Lactotite Retractors	146
Gemini Artery Forceps	61
General Instruments	94
Gennis Elevators, Knives, Dura Hooks	402
Gerald	100
Gerald Dressing Forceps	38
Germanic Laminectomy Rongeurs	263
Gerster Bone Holding clamps	251

Gillies Needle Holder	171, 182
Gill Iris Forceps	489
Gillies Dressing Forceps	100
Gillies Tissue Forceps	41
Gills-Weish Vannas Scissors	512
Girard Corneo-Scieral Forceps	492
Glertz-Stille Sternum Chisel	304
Glover Atrauma Cardiovascular Forceps	331
Gluck Bone And rib Shears	303
Goelet Retractors	130
Goldsmith(thudichum)	272
Gomel Suction Tubes	159
Gorney Platysma Scissors	96
Gorney	95
Gosset Abdominal Retractors	148
Gosset Bladder Retractors	357
Gouges	194-200
Graham Dura hooks	402
Grabber Forceps	466
Gradle Cillia Forceps	499
Gradle Stich Scissor	509
Graefe Retractors	104
Graig Nasal Polypus	277
Grasping and Extracting Forceps	468
Grasping Forceps and Dissecting	468
Grasping Forceps	465-473
Gruenwald	275
Graves Vaginal Specula	365
Green Fixation Forceps	490
Green-Armytage Scalp Flap Forceps	393
Greven Wire Closure Forceps	423
Gross Loops, Foreign Body, Hooks	435
Gross-maier Forceps	79
Gruber Ear Specula	427
Guyon Dilating Bougles	358
Guthrie Retractors	104
Guy Tongue Forceps	441
Guyon Artery Forceps	65-66
Gynecological Scissors Mayo-noble	18
Gynecological Scissors	18
Gynecological Scissors Werthiem	18

H

Haas Tounge Depressors	443
Habrer Abdominal Spatulas	151
Hajek-Claus	285
Hajek	283
Hajek-kofler	283
Halle Bone Curettes	210
Halle Elevators, Knives, Dura Hooks	288, 402
Halsey Needle Holders	167, 177
Halsted-Mosquito Artry forceps	50-51
Hand Drills	250
Harken Atrauma Cardiovascular Forceps	322
Harms Suture Tying Forceps	494, 495
Harrington Retractors	123
Hartmann Artery forceps	50
Hartmann Bone Ronguer Forceps	236
Hartmann Ear Polypus Snares	430
Hartmann Ear Specula	427
Hartmann Nasal Cutting forceps	280
Hartmann Polypus Forceps	275
Hartmann Polypus Forceps	276
Hartmann Tounge Depressors	442
Hartmann Tuning Forks	428

Heath Chalazion Forceps	500
Hegar-Baumgartner	167, 177
Heger-Vascular Needle Holder	181
Heaney Needle Holder	178
Heaney Artery Forceps	68
Heavy Duty Locking Pliers	193
Heavy Duty Locking Pliers	192
Heifetz Tissue Forceps	045
Heifetz Brain Spatulas	399
Heiss Artery Forceps	59
Heister Mouth Gags	438
Helferich-Bier	248
Hemi-Laminectomy Retractors	144
Hemostats Putti	201
Hemostats	201
Henke Tonsil Knives	451
Henley Retractors	138
Henning Plaster Cast Instruments	189
Henrotin Tenaculum Forceps	379
Hepp/scheidel	159
Heyman Nasal Scissors	29
Heymann Polypus Forceps	275
Heywood-Smith	350
Hibbs Bone Chisels	199-200
Hibbs	199-200
Hill-Ferguson Rectal retractors	361
Hirschman Anoscopes	360
Hisschmann	348
Hoen Dura Dissectors	397
Hoen Elevators, Knives, Dura Hooks	402
Hoen Periosteal Raspatories	215
Hohmann Bone Levers	221-223
Hoisher Nerve Root Retractors	400
Hoke	199
Hook Detach Scissors	478
Hook Scissors	477
Hooklets Day	436
Hooklets Lucae	436
Hooklets Wagener	436
Hooklets	436
Hooks Galea	395
Hooks Yasargil Galea	395
Hopkin Plaster Shears	188
Horsley Nerve Root Retractors	398
House-Dieter Crura & Malleus Nippers	424
Huber Broncho-Esophagoscopy Forceps	455
Hudson Hand Drills	250
Hunt Chalazion Forceps	500
Hunter Bowel Forceps	472
Hunter Tissue	046
Hurd Tonsil Knives	451
Hysterectomy Forceps	71

I

Incision Scissors operating scissors	14
Indicator Rotating core	267
Inge Lamina Spreaders	404
Insertor Extractor	267
Instruments For Cranial Opening	337
Intestinal & Stomach Clamps (crushing Clamps)	345
Intestinal & Stomach Clamps Payr-baby	345
Intervertebral Disc Rongeurs	415-417
Intervertebral Disc Ronguer With exchangeable Tips	405
Intestinal Clamp Forceps Brunner	341
Intestinal Clamp Forceps Doyen	341
Intestinal Clamp Forceps Kocher	343

Intestinal Clamp Forceps Mayo-Robson	342
Intestinal Clamp Forceps Mikulicz	344
Intestinal Clamp Forceps Scudder	344
Intestinal Clamp Forceps	341-344
Invertible Disc Rongeurs	406-409
Iodine and Sterilizing Forceps	271
Iris Eye Forceps	488
Iris Forceps Botvin	489
Iris Forceps Chandler	496
Iris Forceps Gill	489
Iris Forceps Von Gaefe	489
Iris Scissor	504-506
Iris Scissors	34
Iris Scissors	94
Israel Retractors	115
Ives-Fansier	348

J

Jackson Rongeurs	416
Jackson-Trachea Tube	362
Jacobs Tenaculum Forceps	379
Jacobson Forceps	487
Jacobson Scissors	486
Jansen Bone Rongeur	236
Jameson Callipers	513
Jameson Muscle Capsule Forceps	501
Jamison Needle Holders	169
Jamison Scissors	98
Jansen Curettes and Spoons	434
Jansen Ear Polypus Snares	429
Jansen-Struycken	281
Janson Retractors	133
Jennings Mouth Gags	439
Jet Wire Twister	268
Jewelers Forceps	493
Jewelers Style Forceps	493
Johns Hopkins	048
Johnson Needle Holders	170
Jones Towel Forceps	72
Joseph-Masing Periosteal Elevator	290
Joseph Dissecting Scissors	23
Joseph Nasal Knives	286
Joseph Rhinoplastic Instruments	293, 295-296
Joseph Septum Elevators	288, 290
Juers Wire Closure Forceps	423

K

Kalt Needle Holder	502
Kalt Needle Holders	163
Katzin Corneal Transplant Scissors	512
Kaye Face Lift Scissors	96
Kelly Artery Forceps	52
Kelly operating Scissors	19
Kelly Protoscopes diameter	360
kelly Anoscope	348
Kelly Retractors	120, 127
Kelly Uterine Polypus Forceps	381
Kelman-Mcpherson Suture tying Forceps	497
Kem Bone Holding Forceps	228
Kern Bone Holding Forceps	228
Kerrison Rongeurs	412
Kerrison Sphenoid punches	285
Kevorkian Suction Biopsy Curettes	384

Kevorkian Biopsy Forceps	387
Key Elevators	220
Kidney Stone Forceps Randall	351
Kidney Stone Forceps	351
Kidney Stone Probes	352
Kielland Obstetrical Forceps	392
Killian polypus Forceps	276
Killan Periosteal Elevators	289
Killian Nasal Specula	273
Killian Rhinoplastic Instruments	291
Killian Septum Scissors	282
Kilner operating Scissors	24
Kilner-Doughty Mouth Gags	439
Kirschner Extension Bows	256
Klinkenbergh Vascular Scissor	25
Knapp Iris Scissor	504
Knight nasal Scissors	95
Knight Polypus Forceps	276
Knives	402
Knives	425
Knowles Bandage Scissors	185
Koacher (Ochsner) Artery Forceps	58
Kocher Artery Forceps	56
Kocher Intestinal Clamp Forceps	343
Kocher Retractors	112
Kocher Retractors	118-119, 121
Koerte Retractors	114
Kogan Endspectula	370
Krause Cutting and Grasping Forceps Tips	456
Krause Ear Polypus Snares	429
Kressner Rhinoplastic Instruments	298
Kristeller Retractors Vaginal Specula	365-366
Kroening Tounge Depressors	443
Kronecker Reverdin Needle	174

L

Laborde	362
La-Force (one Blade)	302
Lahey Artery Forceps	64
Lahey Dura Hooks	403
Lambert-Kay cardiovascular Forceps	324
Lambotte Bone Chisel	197
Lambert Chalazion Forceps	500
Lambotte Bone Holding Forceps	230
Lambotte Periosteal Raspatories	217
Lamina Spreaders Inge	404
Lamina Spreaders	404
Laminectomy Rongeurs	263, 410-414
Lampart Raspatory	437
Landolt Laminectomy Rongeurs	411
Lane Bone Holding Forceps	233
Langenbeck Needle Holder	184
Langenbeck Bone Holding	227
Lange Cutting and Grasping Forceps Tips	456
Lange Rhinoplastic Instruments	295
Langen back	248
Langenbeck Curettes	433
Langenbeck Elevators	219
Langenbeck Periosteal Raspatories	215
Langenbeck Periosteal Raspatories	216
Langenbeck Retractors	116-117, 119
Large Fragment Set	258
Large Pin Cutter	190
Lempert Elevator Raspatories & Curettes	437
Laryngeal mirrors	454

Millin Bladder Retractors	357	Needle Holders Barraquer	163
Mini-Friedman Bone Rongeur	235	Needle Holders Barraquer	164, 176
Mini Detach Scissors	479	Needle Holders Brown	167
Mini Mcgee Alligator	419	Needle Holders Castroviejo	165-166, 176
Mini Oscope Fiber Optic (Pocket)	464	Needle Holders Crile-Murray	168, 171
Mini-Gemini Artery Forceps	61	Needle Holders Derf	167
Mini-Hohmann Bone Levers	221	Needle Holders Fincheitto	170
Mini-Lambotte Bone Chisels	197	Needle Holders Halsey	167
Mini-Langenbeck Retractors	106	Needle Holders Jamison	169
Mini-Roux Retractors	128	Needle Holders Jhonson	170
Mixer Artery Clamps	62	Needle Holders Kalt	163
Mixer Dissecting Forceps	476	Needle Holders Lichtenberg	172
Mixer Gall Stone Scoop	353	Needle Holders Masson	169
Mixer Spender Dissecting Forceps	476	Needle Holders Mathieu	172
Mixer-o'Shaughnessy	62-63	Needle Holders Mayo-Hegar	168, 169
Mod.Muenchen Suction Biopsy Curettes	384	Needle Holders Metzenbaum	168
Mod.Schweden Meniscotomy Knives	225	Needle Holders Neivert	167
Mod.USA Bone Curettes	210	Needle Holders Stratte	171
Mod.USA Umbilical Scissors	31	Needle Holders Webster	167
Mod.Wien Nasal Specula	273	Needle Holders Yasargil	485
Mollison Retractors	136	Needle Nose Dissecting Forceps	474
Molt Mouth Gags	438	Needle Nose Pliers	191
Moore	355	Needles	426
Morris-De Bakey Cardiovascular Forcep	325	Negus Artery Forceps	67
Moritz-Schmidt Tounge Depressors	442	Neivert Needle Holders	167
Mosquito- Dandy Artery Forceps	54	Neivert Rhinoplastic Instruments	297
Mouth Gag Dingman	441	Neleton Probe	4
Mouth Gags Collin	441	Nelson Trocars	156
Mouth Gags Davis-Boyle	440	Nelson Trocars	156
Mouth Gags Denhart	438	Nerve Detacher Orthopedic Set	261
Mouth Gags Guy	441	Nerve Hooks Cushing	401
Mouth Gags Heister	438	Nerve Hooks Scoville	401
Mouth Gags Jennings	439	Nerve Hooks Smithwick	401
Mouth Gags Kilner-Doughty	439	Nerve Hooks	401
Mouth Gags Mcivor	440	Nerve Root Retractors	398
Mouth Gags Molt	438	Nerve Root Retractors	400
Mouth Gags Roser-Konig	438	Nerve Root Retractors	267
Mouth Gags Seemann-Seiffert	439	Neumann Operating and Gum Scissors	32
Mouth Gags Whitehead	439	Neuro-Duoflex Percussion Hammers	153
Mouth Gags Young	441	Neurosurgical Scissors	28
Mouth Gags	438-441	Neurosurgical Scissors Dandy	28
Moynihan Kidney Stone Probes	352	Neurosurgical Scissors Schmieden	28
Mucous Knives	287	Neurosurgical Scissors Strully	28
Muscle Retractors	267	Neurosurgical Scissors Toennis-Adson	28
Museux Tenaculum Forceps	378	Newman Anoscope	348
Myles Nasal Cutting Forceps	280	Noto Uterine Polypus Forceps	381
Myoma Instruments	382	Novak Suction Biopsy Curettes	384
		Nubeor Suction Tubes	162
		Nugent Utility Forceps	494

N

Nabatoff Probes Set	6
Naegele Obstetrical forceps	391
Nail Instruments	247
Nail Nippers Turnbull	269
Nail Nippers	269
Nasal Cutting forceps	278-280
Nasal Knives Joseph	286
Nasal Knives	286
Nasal Polypus Forceps	275-276
Nasal Scissors	29
Nasal Specula	272-274
Needle Holders Collier	167
Needle Holders	484-487, 502-503
Needle Holders	167-172, 175-184
Needle Holders Adson	168
Needle Holders Arruga	164, 176
Needle Holders Baraquer-Troutman	164

O

O'Brien Suture Scissors	509
O'Sullivan-O' Connor	369
O'Sullivan-O' Connor	150
O'Connor Retractors	104
Obstetrical forceps Breisky	391
Obstetrical forceps Collin	391
Obstetrical forceps Dee Lee	392
Obstetrical forceps Kielland	392
Obstetrical forceps Mc Lean	392
Obstetrical forceps Piper	392
Obstetrical forceps Simposon-Braun	391
Obstetrical forceps	391-392
Obstetrical forceps Naegele	391
Obwegeser Awls	448
Obwegeser Chin, Chanselled	445

Q

Quin by Operating and Gum Scissor	32
Quire Ear Polypus Snares	430
Quire Polypus Forceps	276

R

Rabiner Percussion Hammers	152
Ractors Paeker Langenbeck	130
Radolf Nail Instruments	247
Ragnell-Devis Retractors	108
Ramplay Swab forceps	82
Ramus Retractors	445
Randall Suction Biopsy Curettes	384
Randall Kidney Stone Forceps	351
Rankin Crile Artery Forceps	54
Rankin-Kelly Artery Forceps	53
Raspatories	437
Raspatory Lampart	437
Reamers	249
Recamier-Sims-Bumm	389
Reconstructive	95, 97
Rectal Biopsy Specimen Forceps Luer	350
Rectal Biopsy Specimen Forceps	349-350
Rectal Spacula	348
Rectal Specula	347
Reduction Forceps with points	262
Reetractors	361
Reiner Knife	188
Resecting saws	248
Retraction Grasping Forceps	467
Retractor Orthopedic Set	261
Retractors Brunner	122
Retractors Doyen	121
Retractors Gelpi-Lactotite	146
Retractors Israel	115
Retractors Kelly	120, 127
Retractors Kocher	112
Retractors Kocher	118-119, 121
Retractors Koerte	114
Retractors Langenbeck	116-117, 119
Retractors Meyerding	107
Retractors Milligan	137
Retractors Mollison	136
Retractors Ollier	114
Retractors Plester	137
Retractors Ragnell-Devis	108
Retractors Richard Eastmann	120
Retractors Sen-Green	108
Retractors Special Model	113
Retractors Strandell-Stille	110
Retractors Venehaken Brom	110
Retractors Volkmann	110-111
Retractors Wassmund	114
Retractors Adson	135, 139, 141
Retractors Alm	132
Retractors Beckmenn	141-143
Retractors Buckley	132
Retractors Cloward	140
Retractors Darling	145
Retractors Deaver	124-126
Retractors Desmarres	106
Retractors Farabeuf	128
Retractors Finsen	131
Retractors Graefe	104
Retractors Guthrie	104
Retractors Hemi-Laminectomy	144
Retractors Henley	138z

Retractors Janson	133
Retractors Logan	131
Retractors Mathieu	130
Retractors Mini-Langenbeck	106
Retractors Mini-Roux	128
Retractors O'Connor	104
Retractors Parker	128-129
Retractors Retractors	130
Retractors Scalp Contour	133
Retractors Weitlaner	134, 136-137
Retractors	348
Retractors	104-146
Retractors Harrington	123
Retrograde Grasping Forceps	468
Reverdin Abdominal Spatulas	151
Reverdin Needle Deschamps	174
Reverdin Needle Kronecker	174
Reverdin Needle	173-174
Reverdin	173
Reynolds operating scissors	24
Rhinoplastic Instruments	291-298
Rhinoplastic	286
Rhoton Type Structure Tying Forceps	482
Rianer Plaster Shears	188
Rib Shears Sauerbruch	304
Rib Shears	304
Rib Spreaders Cooley	305
Rib Spreaders	305-307
Richard Eastmann Retractors	120
Rochester- Carmalt Artery Forceps	55
Rochester- Pean Artery Forceps	57
Roeder Towel Forceps	72
Roger Periosteal Elevators	289, 290
Rogge Sterilizing Forceps	271
Rosen Knives	425
Rosenberg Cutting and Grasping Forceps Tips	456
Roser-Konig Mouth Gags	438
Roux	127
Rowe Disimpaction Forceps	449
Rubin Septum Scissors	282
Rules and Probes	514
Ruskin Bone Ronguer Forceps	238
Ruskin-Liston Bone cutting Forceps	244
Russ Modell	43
Russian Grasping Forceps	472
Ryder Needle Holder	179, 180

S

Sachs Nerve Root Retractors	398
Saenger Scalp Flap Forceps	393
Safety Screw Driver	261
Samuel Vaginal Specula	368
Sarot Needle Holder	178
Satinsky vascular scissor	25
Satinsky Atrauma Cardiovascular Forceps	321
Satterie	248
Sauer Suture Forceps	496
Sauerbruch Sternum Chisel	304
Sauerbruch-Frey Rib Shears	304
Saurbruch Bone Ronguer Forceps	241
Saws	188
Sawyer Rectal Retractors	361
Schubertt Biopsy Forceps	385, 386
Scalp Contour	133
Scalp Flap Forceps Saenger	393
Scalp Flap Forceps	393

Scalpel Handles	1-2	Sims Sound	374
Scalpel Handles, Standard	1-2	Simile Meniscotomy Knives	225
Schaaf Foreign Body Forceps	496	Simon Bone Curettes	210
Schaedel Towel Forceps	72	Simon Uterine Scoops	388
Schede Bone Curettes	208	Simpson-Braun Obstetrical forceps	391
Schlesinger Ronguers	415	Simpson-Luikart Obstetrical forceps	391
Schmeden Nasal Cutting forceps	280	Sims Rectal Specula	347
Schmeden-Taylor Neurosurgical Scissors	28	Sims Rectal Speculum	359
Schmidt Tonsil Seizing Forceps	452	Sims Scissors	92
Schroeder Tenaculum Forceps	375, 377	Sims Tenaculum Forceps	374
Schroeder Uterine Scoops	388	Sims Vaginal Specula	366
Schuhmacher Umbilical Scissors	31	Sinsky Tying Forceps	498
Schuknecht Knives	425	Skene Tenaculum Forceps	376
Schuknecht Wire Closure Forceps	423	Skull Tractive Bow	265
Schumacher Cutting and Grasping Forceps Tips	456	Skull Tractive Row	266
Schumacher	387	Slip Joint Adjustable Pliers	191
Schwarz Nasal Specula	272	Small Fragment Set	258
Scissors Mayo-Harrington	92	Smith Anal Retractor	359
Scissors Mayo-Stille	87	Smith-Petersen	198
Scissors Sims	92	Smithwick Nerve Hooks	401
Scissors	477	Staude-Moore Forceps	374
Scissors	483, 485-486, 504-512	Stille Plaster Shears	187
Scissors	83-93	Stille-Liston Bone cutting Forceps	245
Scissors Jacobson	486	Straud-Moore Forceps	374
Scissors Yasari	485	Swanstron Graping Forceps	471
Screw Driver	261	Snellen Chalazion Forceps	500
Screw Holding Forceps	267	Soft Tissue Retractors Obwegeser	444-445, 447
Scoops	353	Soft Tissue Retractors	444
Scoville Nerve Root Retractors	400	Somer Uterine Elevating Forceps	383
Scoville Disc Curettes	213	Spare Saw Blade	248
Scoville Nerve Hooks	401	Spare parts Vein Probes Set	6
Screw Tap	267	Special Mod. Britton	188
Scudder Intestinal Clamp Forceps	344	Special model	415
Sedillot Periosteal Raspatories	216	Special Model Bone Holding Forceps	226
Seemann-Seiffert Mouth Gags	439	Special Model Curettes and Spoons	434
Senn-Mueller	108	Special model Nail Instruments	247
Segond Myoma Instruments	382	Special Model Nasal Specula	273
Seiffert Cutting and Grasping Forceps Tips	456	Special Model Nerve Root Retractors	400
Sellheim Elevating Spoon	393	Special Model Obstetrical forceps	391
Self Cantering Bone Holding	232, 262	Special Model Retractors	113
Selzing Forceps	252	Special Model Tenaculum Forceps	374
Semb Bone Holding Forceps	228	Special Model Tounge Depressors	443
Semb Bone Ronguer Forceps	239, 246	Specialization	481
Semb Periosteal Raspatories	218	Special-mobile Percussion Hammers	152
Semken Dressing Forceps	38	Specimen Forceps	385, 387
Semken	42, 100	Spectrum Compression forceps	281
Semm Vaginal Specula	365	Specula	359-360
Semmes (Howard)	212	Spencer Ligature Scissors	35
Sen-Green Retractors	108	Sphenoid punches	283, 285-284
Sensibility Instruments	154	Spinal Fusion Curettes	212
Sensibility Instruments Aly	154	Spinal Gauge	259
Sensibility Instruments Weber	154	Spinal Gouges	259
Septum Compression Forceps	276	Spinal Plato Retractor	268
Septum elevators Freer	288	Spinal Retractors	224
Septum elevators Joseph	288	Sponge holders	7
Septum elevators	288	Spoon Forceps	481
Septum knife	287	Spratt Bone Curettes	208
Septum Scissors	282	Spreaders Lamina	404
Shank Bones and Splinter Bone	268	Spurling Laminectomy Rongeurs	410
Shapleigh Curettes	433	Spurling ronguers	263
Sharp Curettes Faulkner	299	St. Clair-Thomson	301
Sharp Curettes	299	Stacke Probe	4
Sharp Curettes Coakley	299	Stainbatch Mallets	20, 204
Sharp Curettes Prapp	299	Standard Dressing Forceps	36-38
Sheehan Rhinoplastic Instruments	293	Standard Narrow Dressing Forceps	36-37
Sheets-Mcpherson Tying Forceps	498	Standard Operating Scissors	8-13
Shepard Intraocular Lens Flare	499	Standard Scalpel Handles	1-2
Shepard Tying Forceps	498	Standard Scissors	83-85
Silver Rhinoplastic Instruments	293	Standard Trocars	155

T

Standard Tubing Clumps	73	Tabb Knives	425
Steel Rule	514	Takahashi Nasal Cutting forceps	278
Steinman Pins Traction Bow	266	Takahashi Rongeur	416
Stellbrink Bone Ronguer Forceps	235	Tap (T-type handle)	260
Sterilizing Forceps Rogge	271	Tapered Dissecting Forceps	474
Sternum Chisel Glertz-Stille	304	Tapered Maryland Dissecting Forceps	475
Sternum Chisel	304	Taylor Spinal Retractors	224
Sternum Chisel Lebsche	304	Taylor Dressing Forceps	38
Sternum Chisel Sauerbruch	304	Taylor Percussion Hammers	153
Sternum Scissors Brunner	304	TC Grasping Forceps	465
Sternum Scissors Lebsche	304	Teale Tenaculum Forceps	377
Sternum Scissors	304	Tenaculum Forceps	374
Stevens Tenotomy Scissors	508	Tenaculum Forceps	375-380
Stille Bone And rib Shears	303	Tenotomy Fine operating Scissor	33
Stille Bone Chisels	196	Tenotomy Scissors	34
Stille Bone Ronguer Forceps	239	Thoms-Gaylor Cervical Biopsy	385-386
Stille Ruskin Bone Ronguer Forceps	239	Thorax Scissors	25-27
Stille-Luer Bone Ronguer Forceps	240-241	Thorpe Callipers	513
Stille-Liston Bone Cutting Forceps	245	Thorpe Conjunctional Fixation Forceps	490
Stitch Scissor	509	Thronton Intraocular Lens Forceps	499
Stone Extractor	473	Tieck-halle Nasal Specula	273
Stone tissue forceps	41	Tissue and Organ Holding Forceps Allis	339
Stookey Carnial Ronguer	417	Tissue and Organ Holding Forceps Allis-Adair	339
Strabismus Fine operating Scissor	34	Tissue and Organ Holding Forceps Allis-Atrauma	338
Strabismus Scissor	507	Tissue and Organ Holding Forceps Allis-Baby	338
Straight Shaft	426	Tissue and Organ Holding Forceps Duval	340
Strandell-Stille Retractors	110	Tissue and Organ Holding Forceps Lovelace	308
Stratte Needle Holders	171, 182	Tissue and Organ Holding Forceps William	339
Strethoscope Pinard	154	Tissue and Organ Holding Forceps	308, 338-340
Strethoscope	154	Tissue Forceps AdlerKreutz	41
Strong Atraumatic Grasping Forceps	473	Tissue Forceps Lerche	41
Strong Grasping Forceps	465	Tissue Forceps Adson	41
Strully Neurosurgical Scissors	28	Tissue Forceps Gillies	41
Struycken Nasal Cutting forceps	279	Tissue forceps Stone	41
Stryker-Scholl Meniscotomy Knives	225	Tissue Forceps	39-43
Suction Biopsy Curettes	384	Tobold Tounge Depressors	442
Suction Tubes Adson	158	Toennis Needle Holder	184
Suction Tubes Byrd	162	Toennis Needle Holder	172
Suction Tubes Cogoswell	162	Toennis-Adson Neurosurgical Scissors	28
Suction Tubes Cooley	161	Toennis-Adson	91
Suction Tubes Coupland	162	Tonsil Knives Abraham	450
Suction Tubes Frazier	158	Tonsil Knives Bruenings	450
Suction Tubes Gomel	159	Tonsil Knives Carpenter	451
Suction Tubes Nubeor	162	Tonsil Knives Henke	451
Suction Tubes Poole	161	Tonsil Knives Hurd	451
Suction Tubes poppen	158	Tonsil Knives	450
Suction Tubes Yankauer	160	Tonsil Scissors	29
Suction Tubes Yasargill	159	Tonsil Seizing Forceps Ballenger	452
Suction Tubes	158-162	Tonsil Seizing Forceps Blohmke	452
Suction TubesWullstein	158	Tonsil Seizing Forceps Clover	452
Supercut Detach Scissors	478	Tonsil Seizing Forceps Schnidt	452
Supercut Iris Scissor	505	Tonsil Seizing Forceps White	452
Supercut Scissors	94-99	Tonsil Seizing Forceps	452
Supercut Scissors	477	Tonsil Snares Bruenings	453
Suture Forceps Casterveijo	492	Tonsil Snares Eves	453
Suture Forceps Sauer	496	Tonsil Snares Tyding	453
Suture Forceps	491-492	Tonsil Snares	453-454
Suture Forceps Pierse	492	Tornado Bandage Scissors	185
Suture tying Forceps Kelman-Mcpherson	497	Toung Depressors Andrew	442
Suture tying Forceps Mcpherson	497	Toung Depressors Bruenings	443
Swab Forceps	81-82	Toung Depressors Mayo	443
Swanstron Grasping Forceps	471	Toung Depressors Boilate	443
Swivel knives	287	Toung Depressors Buchwald	443
		Toung Depressors Collin	443
		Toung Depressors Doyen	443
		Toung Depressors Frenzel	443
		Toung Depressors Haas	443
		Toung Depressors Hartmann	442
		Toung Depressors Kroening	443

Tounge Depressors Moritz-Schmidt	442
Tounge Depressors Special Model	443
Tounge Depressors Tobold	442
Tounge Depressors Wieder	442
Tounge Depressors	442-443
Towel Forceps	72
Towel Forceps Backhaus	72
Towel Forceps Jones	72
Towel Forceps Lorna	72
Towel Forceps Roeder	72
Towel Forceps Schaedel	72
Townley Femur Calliper	193
Toynbee Ear Specula	427
Trachea Dilators	362
Trelat Vaginal Specula	364
Trocars Duke	156
Trocars	155-157
Trocars Billrot	157
Trocars Buelau	156
Trocars Campbell	156
Trocars Fleurant	157
Trocars Ochsner	157
Trocars Standard	155
Trocars Universal	155
Troeltsch (wilde) Ear Polypus Snares	429
Troemner Percussion Hammers	153
Troltsch Polypus Forceps	275
Trousseau Laborde	362
Troutman Needle Holders	503
Troutman Superior Rectus Forceps	501
Troutman-Barraquer Utility Forceps	495
Troutman-Casterveijo Corneal Suction Scissors	511
Troutmann-Barraquer Utility Forceps	491
Tubing Clumps Standard	73
Tubing Clumps	73
Tuffire Bone Holding Forceps	229
Tumer Forceps	81-82
Tungsten Carbide Inserts	83-93, 100-103, 175-184
Tungstun Carbide	252-255
Tuning Forks Hartmann	428
Tuning Forks	428
TurnBull Nail Nippers	269
Tyding Tonsil Snares	453
Tying Forceps Sheets-Mcpherson	498

U

Ulrich Bone Holding Forceps	231
Umbilical Scissors Busch	31
Umbilical Scissors Mod.USA	31
Umbilical Scissors Schumacher	31
Umbilical Scissors	31
Universal Bone Ronguer Forceps Universal	235
Universal Bone Ronguer Forceps	235
Universal Handle And Interchangeable Tubes	455
Universal Ligature Scissors	35
Universal Trocars	155
Uterine Curettes	389, 390
Uterine Dilators	371-373
Uterine Polypus Forceps	381
Uterine Scoops	388
Uterine Scoops Schroeder	388
Uterine Scoops Simon	388
Uterine Sounds	374
Uterine Elevating Forceps	383
Utility and Suture Forceps	494-498

Utility Forceps Bonaccolto	495
Utility Forceps Casterveijo	495
Utility Forceps Mccullough	494
Utility Forceps Nugent	494
Utility Forceps Polack	495
Utility Forceps Troutman-Barraquer	495
Utility Forceps Whills Hospital	494
Utility Scissor	506

V

Vaginal Forceps Wertheim	71
Vaginal Forceps	71
Vaginal Specula	363-369
Van Burn Dilating Bougles	358
Van Doren	386
Vannas Capsulotomy Scissors	511
Vascular Needle Holder	175
Vascular Scissor Dietrich	26
Vascular Scissors	25-27
Vasculolar scissor Klinkenbergh	25
Vein Probes Set Spare parts	6
Vein Probes Set	6
Venehaken Brom Retractors	110
Verbugge Bone Holding Forceps	234
Volkman Bone Curettes	213
Volkman Bone Curettes	207-208, 211
Volkman Retractors	110-111
Voltolini Nasal Specula	272
Von Gaefe Iris Forceps	489
Von Graefe Fixation Forceps	490

Wagener Hooklets	436
Walter Carmalt tissue forcep	046
Waldmann Episiotomy Scissors	30
Wangensteen	103, 170
Walton Nail Instruments	247
Wartenberg	154
Wassmund Retractors	114
Watson-williams Nasal Cutting forceps	278
Watzke Sleeve Spreading Forceps	496
Weber Atrauma Cardiovascular Forceps	320
Weber Sensibility Instruments	154
Webster Needle Holders	167, 177
Weil Nasal Cutting Forceps	279
Weitlaner Retractors	134, 136-137
Wertheim Gynecological Scissors	18
Wertheim Vaginal Forceps	71
Werthiem-cullen Artery Forceps	69-71
Westcott Utility Scissor	508
Westmacott Polypus Forceps	275
Whills Hospital Utility Forceps	494
White Tonsil Seizing Forceps	452
Whitehead Mouth Gags	439
Wickstrom Artery Forceps	63
Wieder Tounge Depressors	442
Wilde Ronguers	415
Williger Mallets	202
William Tissue and Organ Holding Forceps	339
Williams Lacrimal Probes	514
Williger Bone Curettes	209
Williger Bone Curettes	211
Williger Elevators	219

Williger Periosteal Raspatories	217
Willstein Micro ear Forceps	422
Wilmer Conjunctival Scissor	506
Wills Hospital utility Forceps	494
Williger Mallets	202
Winter Scalp Flap Forceps	393
Wire Closure Forceps	423
Wire Cutters	190
Wire Cutting Forceps	264-265
Wire Cutting Pliers	252, 254-255
Willstein Knives	425
Wullstien Micro Scissor	422
Wolff Plaster Cast Instruments	189
Wullstein Suction Tubes	158

Y

Yankauer Nasal Specula	274
Yankauer Suction Tubes	160
Yasargil Forceps	45, 485
Yasargil Galea Hooks	395
Yasargil Laminectomy Rongeurs	411
Yasargil Needle Holders	485
Yasargil Suction Tubes	159
Yasargil Scissors	485
Yeoman Rectal Biospy Specimen Forceps	349
Yankauer	297
Young Mouth Gags	441
Young Prostatic Retractors	356

Z

Zaufal Loops, Foreign Body, Hooks	435
Zaufal-jansen Bone Rongeur	238
Ziegler Cilia Forceps	499
Zweifel Needle Holder	184
Zoliner Ear Specula	427

This Catalogue is
Designed & Printed by:

Print  *a print solutions company*
Amalgamation of Photography, Design & Print.



Office Address:
Suite # 3, 1st Floor, Able Plaza,
Near Overhead Bridge
Saket 51310 - Pakistan

Voice:
+92-52-4593200

Cell:
+92-300-7103200
+92-315-8103200

E-mail:
General Inquiries:
info@printsols.com

Skype:
printsols

Website:
www.printsols.com

Support & Services:
office@printsols.com





TALC INDUSTRIES

ONE STOP FOR MEDICAL EQUIPMENT

www.talcindustries.com



TALC INDUSTRIES

ONE STOP FOR MEDICAL EQUIPMENT

Pacca Garha, Kashmir Road,
Sialkot 51310, Punjab, Pakistan

Tel: +92 52 429 5908

Fax: +92 52 435 2475

Cell: +92 334 111 2411, 315 111 2411

What'sapp +92 321 613 8119

Skype/Wechat/Line: talcinds

Email: inquiry@talcindustries.com
talcinds@gmail.com

Web: www.talcindustries.com

